

Contents

1	Instructions	4
1.1	General safety instructions	4
1.2	Appliance purpose	7
1.3	Manufacturer liability	7
1.4	Manufacturer liability	7
1.5	This user manual	7
1.6	Identification plate	7
1.7	Disposal	8
1.8	How to read the user manual	8
2	Description	9
2.1	General Description	9
2.2	Control panel	10
2.3	Other parts	10
2.4	Available accessories	11
3	Use	12
3.1	Instructions	12
3.2	First use	12
3.3	Using the accessories	13
3.4	Using the oven	13
3.5	Cooking advice	15
3.6	"Touch" Programmer clock	16
4	Cleaning and maintenance	22
4.1	Instructions	22
4.2	Cleaning the appliance	22
4.3	Cleaning the door	23
4.4	Cleaning the inside of the oven	25
4.5	Extraordinary maintenance	28
5	Installation	29
5.1	Electrical connection	29
5.2	Positioning	30

ORIGINAL INSTRUCTIONS

We advise you to read this manual carefully, which contains all the instructions for maintaining the appliance's aesthetic and functional qualities.

For further information on the product: www.smeg.com



Instructions

1 Instructions

1.1 General safety instructions

Risk of personal injury

- During use the appliance becomes hot. Care should be taken to avoid touching heating elements inside the oven.
- **WARNING** - Accessible parts will become hot when in use. Young children should be kept away.
- Protect your hands by wearing oven gloves when handling food inside the oven cavity.
- Never try to put out a fire or flames with water: turn off the appliance and smother the flames with a fire blanket or other appropriate cover.
- The appliance is not intended for use by persons (including children) with reduced physical, sensory or mental capabilities, or lack of experience and knowledge, unless they have been given supervised or instructions concerning use of the appliance by a responsible person for their safety.
- Young children should be supervised to ensure that they do not play with the appliance.
- Keep children under eight years of age at a safe distance if they are not constantly supervised.
- Do not allow children younger than 8 years old to come near the appliance when in operation.
- The appliance must never be cleaned by unsupervised children.
- The cooking process must always be monitored. Short cooking processes must be monitored continuously.
- Never leave the appliance unattended during cooking operations in which fats or oils could be released that could overheat and catch fire. Be very careful.
- Do not insert pointed metal objects (cutlery or utensils) into the slots in the appliance.
- Do not pour water directly onto very hot trays.
- Keep the oven door closed during cooking.
- If you need to move food or at the end of cooking, open the door 5 cm for a few seconds, let the steam come out, then open it fully.
- **DO NOT USE OR STORE FLAMMABLE MATERIALS NEAR THE APPLIANCE.**
- **WARNING:** Ensure the appliance is switched off before replacing the lamp to avoid the possibility of electric shock.



- DO NOT SPRAY AEROSOLS IN THE VICINITY OF THIS APPLIANCE WHILE IT IS IN OPERATION.
- Switch the appliance off immediately after use.
- DO NOT MODIFY THIS APPLIANCE.
- Always use any necessary/required personal protective equipment (PPE) before performing any work on the appliance (installation, maintenance, positioning or movement).
- Disconnect the main power supply before performing any work on the appliance.
- Have authorised personnel carry out installation and assistance interventions according to the standards in force.
- Do not try to repair the appliance yourself or without the intervention of a authorised technician.
- Do not pull the cable to remove the plug.
- If the power supply cable is damaged, contact technical support immediately and they will replace it.

Risk of damaging the appliance

- Do not use abrasive or corrosive detergents (e.g. scouring powders, stain removers and metallic sponges) on glass parts. Use wooden or plastic utensils.
- Racks and trays must be inserted as far as they will go into the side guides. The mechanical safety locks that prevent them from being removed must face downwards and towards the back of the oven cavity.
- Do not seat on the appliance.
- Do not use a steam cleaner to clean the appliance.
- Do not obstruct ventilation openings and heat dispersal slots.
- DO NOT USE THE APPLIANCE TO HEAT ROOMS FOR ANY REASON.
- Do not spray any spray products near the oven.
- Do not use plastic kitchenware or containers when cooking food.
- Do not put sealed tins or containers in the oven.
- Remove all trays and racks which are not required during cooking.
- Do not cover the bottom of the oven cavity with aluminium or tin foil sheets.



Instructions

- Do not place pans or trays directly on the bottom of the oven cavity.
- If you wish to use greaseproof paper, place it so that it will not interfere with the hot air circulation inside the oven.
- Do not use the open door to rest pans or trays on the internal glass pane.
- Do not use cleaning products containing chlorine, ammonia or bleach on steel parts or parts with metallic surface finishes (e.g. anodizing, nickel- or chromium-plating).
- Do not use rough or abrasive materials or sharp metal scrapers.
- Do not use harsh abrasive cleaners or sharp metal scrapers to clean the oven glass since they can scratch the surface, which may result in shattering of the glass.
- the appliance into place when fitting.
- When positioning the appliance during installation, do not use the door handle to lift up or move this appliance.
- Avoid exerting too much pressure on the oven door when open.
- This oven must not be installed behind a decorative door in order to avoid overheating.
- Have authorised persons carry out installation and assistance interventions according to the standards in force.
- Have the electrical connection performed by authorised persons.
- The appliance must be connected to earth in compliance with electrical system safety standards.
- Use cables withstanding a temperature of at least 90 °C.
- The tightening torque of the screws of the terminal supply wires must be 1.5 - 2 Nm.

Installation

- **THIS APPLIANCE IS NOT TO BE INSTALLED IN MARINE CRAFT OR IN CARAVANS.**
- The appliance must not be installed on a pedestal.
- Place the appliance into the piece of furniture with the aid of a second person.
- Never use the oven door to lever
- Before carrying out any work on the appliance (installation, maintenance, positioning or moving), wear personal protective equipment.
- Before carrying out any work on the appliance, disconnect the mains power supply.
- If the electrical supply is restricted,



means of all-pole disconnection must be accessible and incorporated in the fixing wiring in accordance with the wiring rules.

For this appliance

- Ensure that the appliance is switched off before replacing the bulb.
- Do not rest any weight or sit on the open door of the appliance.
- Take care that no objects are stuck in the doors.
- Excess spillage must be removed before starting the pyrolytic cleaning function.
- During the pyrolytic cleaning function, please note that outside surfaces may become hotter than usual. Please ensure children are kept away.

1.2 Appliance purpose

- This appliance is intended for cooking food in the home environment. Every other use is considered improper.
- The appliance is not designed to operate with external timers or with remote-control systems.

1.3 Manufacturer liability

The manufacturer declines all liability for damage to persons or property caused by:

- use of the appliance other than the

one envisaged;

- failure to comply with the instructions in the user manual;
- tampering with any part of the appliance;
- the use of non-original spare parts.

1.4 Manufacturer liability

The manufacturer declines all liability for damage to persons or property caused by:

- use of the appliance other than the one envisaged;
- non-observance of the user manual provisions;
- tampering with any part of the appliance;
- use of non-original spare parts.

1.5 This user manual

This user manual is an integral part of the appliance and must therefore be kept in its entirety and in an accessible place for the whole working life of the appliance. Read this user manual carefully before using the appliance.

1.6 Identification plate

- The identification plate bears the technical data, serial number and brand name of the appliance. Do not remove the identification plate for any reason.



Instructions

1.7 Disposal

To dispose of the appliance:

- Cut the power supply cable and remove it along with the plug.



Power voltage Danger of electrocution

- Disconnect the main power supply.
- Disconnect the power cable from the electrical system.
- Consign the appliance to the appropriate selective collection centres for electrical and electronic equipment waste, or deliver it back to the retailer when purchasing an equivalent product, on a one for one basis.

Our appliances are packed in non-polluting and recyclable materials.

- Consign the packing materials to the appropriate selective collection centres.



Plastic packaging Danger of suffocation

- Do not leave the packaging or any part of it unattended.
- Do not let children play with the packaging plastic bags.

1.8 How to read the user manual

This user manual uses the following reading conventions:

Instructions



General information on this user manual, on safety and final disposal.

Description



Description of the appliance and its accessories.

Use



Information on the use of the appliance and its accessories, cooking advice.

Cleaning and maintenance



Information for proper cleaning and maintenance of the appliance.

Installation



Information for authorised persons: installation, operation and inspection.



Safety instructions



Information



Advice

1. Sequence of instructions for use.

- Standalone instruction.



2 Description

2.1 General Description

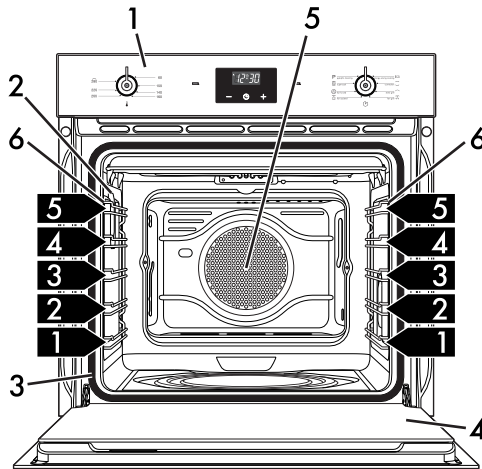

1 Control panel

2 Oven light

3 Seal

4 Door

5 Fan

6 Rack/tray support frames

1,2,3... Frame shelf



Description

2.2 Control panel

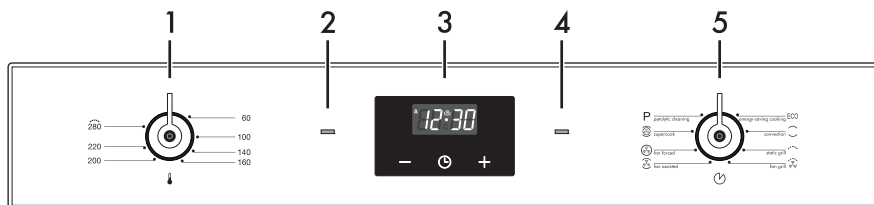

1 Temperature knob

This knob allows you to select the cooking temperature.

Turn the knob clockwise to the required value, between the minimum and maximum setting.

2 Thermostat indicator light

The indicator light comes on to indicate that the oven is heating up. It turns off as soon as it reaches the set temperature. It flashes regularly to indicate that the temperature set is kept constant inside the oven.

3 “Touch” Programmer clock

Useful for displaying the current time, setting programmed cooking operations and programming the minute minder timer.

4 Door lock indicator light

It comes on when the automatic cleaning cycle (pyrolytic cleaning) is activated.

5 Function knob

The oven's various functions are suitable for different cooking modes. After selecting the required function, set the cooking temperature using the temperature knob.

2.3 Other parts

Shelves

The appliance features shelves for positioning trays and racks at different heights. The insertion heights are indicated from the bottom upwards (see 2.1 General Description).

Cooling fan

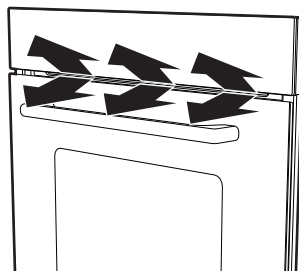

The fan cools the oven and comes into operation during cooking.

The fan causes a steady outflow of air from above the door which may continue for a brief period of time even after the appliance has been turned off.



Interior lighting

The appliance's interior lighting comes on:

- When the door is opened.
- When any function is selected, apart from the ECO **ECO** and Pyrolytic **P** functions.



When the door is open, it is not possible to turn off the interior lighting.

2.4 Available accessories

Tray

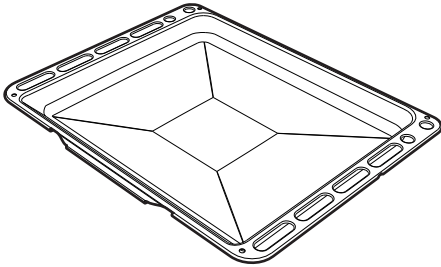

Useful for collecting fat from foods placed on the rack above and for cooking pies, pizzas and baked desserts.

Tray rack

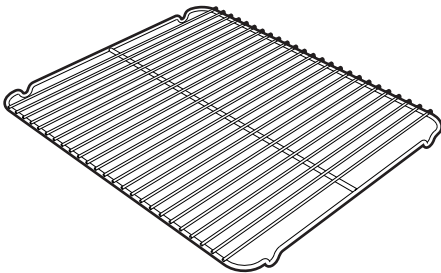

To be placed over the top of the oven tray; for cooking foods which may drip.

Rack

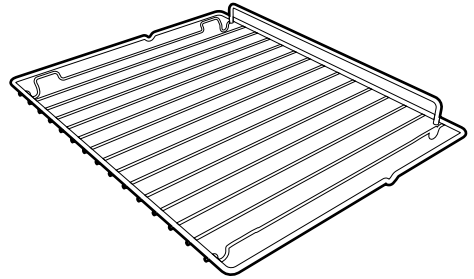

Used for supporting containers with food during cooking.



Some models are not provided with all accessories.



The oven accessories intended to come into contact with food are made of materials that comply with the provisions of current legislation.



Original supplied and optional accessories can be requested to Authorised Assistance Centres. Use only original accessories supplied by the manufacturer.



3 Use

3.1 Instructions



High temperature inside the oven during use

Danger of burns

- Keep the oven door closed during cooking.
- Protect your hands wearing heat resistant gloves when moving food inside the oven.
- Do not touch the heating elements inside the oven.
- Do not pour water directly onto very hot trays.
- Do not allow children to get near the oven when it is in operation.



High temperature inside the oven during use

Danger of fire or explosion

- Do not spray any spray products near the oven.
- Do not use or leave flammable materials near the oven.
- Do not use plastic kitchenware or containers when cooking food.
- Do not put sealed tins or containers in the oven.
- Do not leave the oven unattended during cooking operations where fats or oils could be released.
- Remove all trays and racks which are not required during cooking.



Improper use

Risk of damage to enamelled surfaces

- Do not cover the bottom of the oven cavity with aluminium or tin foil sheets.
- If you wish to use greaseproof paper, place it so that it will not interfere with the hot air circulation inside the oven.
- Do not place pans or trays directly on the bottom of the oven cavity.
- Do not pour water directly onto very hot trays.

3.2 First use

1. Remove any protective film from the outside or inside of the appliance, including accessories.
2. Remove any labels (apart from the technical data plate) from the accessories and from the oven cavity.
3. Remove and wash all the appliance accessories (see 4 Cleaning and maintenance).
4. Heat the empty oven at the maximum temperature to burn off any residues left by the manufacturing process.



3.3 Using the accessories

Racks and trays

Racks and trays have to be inserted into the side guides until they come to a complete stop.

- The mechanical safety locks that prevent the rack from being removed accidentally must face downwards and towards the back of the oven cavity.

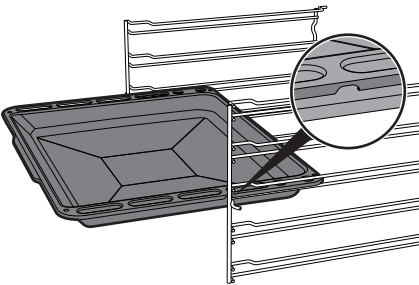
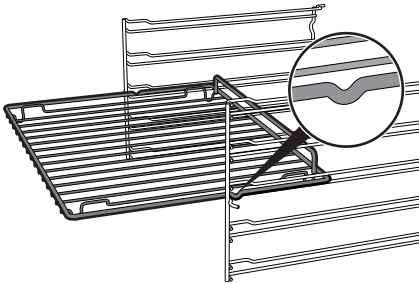

Carefully insert the racks and trays as far as they will go into the oven cavity.



Clean the trays before using them for the first time to remove any residues left by the manufacturing process.

Tray rack

The tray rack has to be inserted into the tray. In this way, fat can be collected separately from the food that is being cooked.

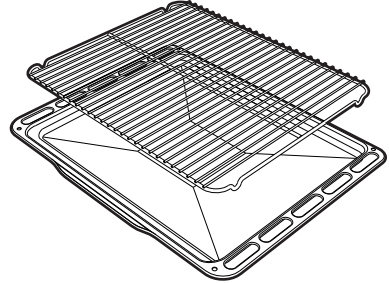

3.4 Using the oven

Switching on the oven

To switch on the oven:

- Select the cooking function using the function knob.
- Select the temperature using the temperature knob.



Regular flashing of the thermostat indicator light during cooking is normal and indicates that the temperature is being maintained constant inside the oven.



Ensure that the programmer clock shows the cooking duration symbol , otherwise it will not be possible to turn on the oven.

Press the key  to reset the programmer clock.



Functions list

ECO

ECO (Energy-saving cooking)

This low energy consumption function is particularly suitable for cooking on a single shelf.

Ideal when cooking meat, fish and vegetables. It is not recommended for foods that require proving.

For greater energy savings and to reduce the time required, it is recommended to put foods in the oven cavity without preheating it.



When using the ECO function, avoid opening the oven door during cooking.



When using the ECO function, cooking times (and pre-heating, if used) are longer.



Convection

As the heat comes from above and below at the same time, this system is particularly suitable for certain types of food. Traditional cooking, also known as static cooking, is suitable for cooking just one dish at a time. Perfect for all types of roasts, bread and cakes and in any case particularly suitable for fatty meats such as goose and duck.



Static grill

The heat coming from the grill element gives perfect grilling results above all for thin and medium thickness meat and in combination with the rotisserie (where fitted) gives the food an even browning at the end of cooking. Perfect for sausages, spare ribs and bacon. This function enables large quantities of food, particularly meat, to be grilled evenly.



Fan grill

The air produced by the fan softens the strong heatwave generated by the grill, grilling perfectly even very thick foods. Perfect for large cuts of meat (e.g. pork hock).



Fan assisted

The operation of the fan, combined with traditional cooking, ensures consistent cooking even with complex recipes. Perfect for biscuits and cakes, even when simultaneously cooked on several levels. (For multiple-level cooking, we recommend using the 2nd and 4th shelf).



Fan forced

The combination of the fan and the circular heating element (incorporated in the rear of the oven) allows you to cook different foods on several levels, as long as they need the same temperatures and same type of cooking. Hot air circulation ensures instant and even distribution of heat. It will be possible, for instance, to cook fish, vegetables and biscuits simultaneously (on different levels) without odours and flavours mingling.



Supercook

The combination of fan assisted cooking and traditional cooking allows different foods to be cooked on several levels extremely quickly and efficiently, without odours and flavours mingling. Perfect for large volumes that call for intense cooking. (For multiple-level cooking, we recommend using the 1st and 4th shelves.)



Pyrolytic cleaning

Setting this function, the oven reaches temperatures up to 500°C, destroying all the grease which forms on the internal walls.

3.5 Cooking advice

General advice

- Use a fan assisted function to achieve consistent cooking at several levels.
- It is not possible to shorten cooking times by increasing the temperature (the food could be overcooked on the outside and undercooked on the inside).

Advice for cooking meat

- Cooking times vary according to the thickness and quality of the food and to consumer taste.
- Use a meat thermometer when roasting meat, or simply press on the roast with a spoon. If it is hard, it is ready; If not, it needs another few minutes cooking.

Advice for cooking with the Grill and the Fan grill

- Meat can be grilled even when it is put into the cold oven or into the preheated oven if you wish to change the effect of the cooking.
- With the Fan grill function, we recommend that you preheat the oven before grilling.
- We recommend placing the food at the centre of the rack.
- With the Grill function, we recommend that you turn the temperature knob to the maximum value near the  symbol to optimise cooking.



Use

Advice for cooking desserts/pastries and biscuits

- Use dark metal moulds: They help to absorb the heat better.
- The temperature and the cooking time depend on the quality and consistency of the dough.
- To check whether the dessert is cooked right through: At the end of the cooking time, put a toothpick into the highest point of the dessert. If the dough does not stick to the toothpick, the dessert is cooked.
- If the dessert collapses when it comes out of the oven, on the next occasion reduce the set temperature by about 10°C, selecting a longer cooking time if necessary.

Advice for defrosting and proving

- Place frozen foods without their packaging in a lidless container on the first shelf of the oven.
- Avoid overlapping the food.
- To defrost meat, use the rack placed on the second level and a tray on the first level. In this way, the liquid from the defrosting food drains away from the food.
- The most delicate parts can be covered with aluminium foil.
- For successful proving, a container of water should be placed in the bottom of the oven.

To save energy

- Stop cooking a few minutes before the time normally used. Cooking will continue for the remaining minutes with the heat which has accumulated inside the oven.
- Reduce any opening of the door to a minimum to avoid heat dispersal.
- Keep the inside of the appliance clean at all times.

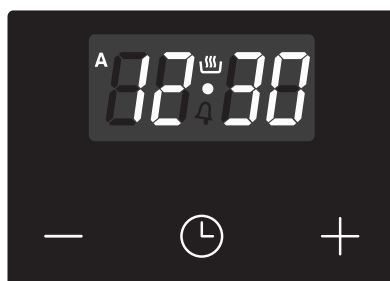

3.6 "Touch" Programmer clock



 Value decrease key

 Clock key

 Value increase key

 Ensure that the programmer clock shows the cooking duration symbol  otherwise it will not be possible to turn on the oven.





Press the key  to reset the programmer clock.





Setting the time

i If the time is not set, the oven will not switch on.









On the first use, or after a power failure, the digits  will be flashing on the appliance's display.

1. Hold down the clock key  for two seconds. The dot between the hours and the minutes flashes.
2. The time can be set via the value increase key  and value decrease key . Keep the key pressed in to increase or decrease rapidly.
3. Wait 7 seconds. The dot between the hours and the minutes stops flashing.
4. The symbol  on the display indicates that the appliance is ready to start cooking.

 To change the time, hold down the value increase key  and value decrease key  at the same time for two seconds, then set the time.

Timed cooking

i Timed cooking is the function which allows a cooking operation to be started and then ended after a specific length of time set by the user.

1. Keep the clock key  pressed until the symbol  appears.
1. Press the clock key  again. On the display the symbol  and the text  appear, alternating with the current time.
2. Use the value increase  and value decrease  keys to set the required minutes of cooking.
3. Select a function and a cooking temperature.
4. Wait approx. 5 seconds without pressing any key in order for the function to activate. The current time and the symbols  and  will appear on the display.



Use

At the end of cooking the heating elements will be deactivated. On the display, the symbol  turns off, the symbol **A** flashes and the buzzer sounds.



5. To turn the buzzer off, simply press one of the programmer clock keys.

6. Press the clock key  to reset the programmer clock.



It is not possible to set a cooking time of more than 10 hours.













To cancel the set programming press and hold down the value increase  and the value decrease  keys at the same time and then turn the oven off manually.

Programmed cooking









Programmed cooking is the function which allows a cooking operation to be started at a set time and then ended after a specific length of time set by the user.

1. Set the cooking time as described in the previous point "Timed cooking".
2. Hold the menu key  down for 2 seconds.
3. Press the menu key  again. The display will show the digits  and the text  in sequence, while the **A** symbol flashes (for example, the current time is 17:30)
4. Use the  or  key to set the required minutes (for example 1 hour)
5. Press the menu key . The text  will appear on the display in sequence with the pre-set cooking duration added to the current time (for example, the cooking end time shown is 18:30).
6. Press the  or  key to set the cooking end time. (for example, 19:30).



Bear in mind that a few minutes for oven preheating must be added to the cooking time.



7. Wait approx. 7 seconds without pressing any key in order for the function to activate. The current time will appear on the display, and the symbols  and  will turn off while the  indicator light comes on.
8. Select a cooking temperature and function.
9. At the end of cooking the heating elements will be deactivated. On the display, symbol  turns off, symbol  flashes and the buzzer sounds.
10. Return the function and temperature knobs to **0**.
11. To turn off the buzzer just press any key of the programmer clock.
12. Press keys  and  at the same time to reset the set program.





It is not possible to set a cooking time of more than 10 hours.



It is not possible to set a programmed cooking time of more than 24 hours.









After setting, hold the menu key  down for 2 seconds to display the cooking time remaining. Press the menu key  again. The display shows the text  and the remaining cooking time in sequence.

Minute minder timer



The minute minder timer does not stop the cooking operation but rather informs the user when the set time has run out.

The minute minder timer can be activated at any time.

1. Keep the clock key  pressed for per a few seconds. The display shows the figures  and the symbol  flashing between the hours and minutes.
2. Use the value increase  and value decrease  keys to set the number of minutes required.
3. Wait approx. 5 seconds without pressing any key to finish setting the minute minder. The current time and the symbols  and  appear on the display.

A buzzer will sound when the set time is reached.



4. Press the value decrease key  to turn the buzzer off.





The minute minder timer can be set from 1 minute to a maximum of 23 hours and 59 minutes.



Modifying the set data





1. Press the clock key .
2. Use the value increase  and value decrease  keys to set the number of minutes required.

Deleting the set data

1. Press the clock key .
2. Hold down the value increase  and value decrease  keys at the same time.
3. Then switch off the oven manually if cooking is in progress.

Selecting the buzzer

The buzzer can have 3 tones.

1. Hold down the value increase  and value decrease  keys at the same time.
2. Press the clock key .
3. Press the value decrease key  to select a different buzzer tone.



Cooking information table

Food	Weight (Kg)	Function	Shelf	Temperature (°C)	Time (minutes)	
Lasagne	3 - 4	Convection	1	220 - 230	45 - 50	
Pasta bake	3 - 4	Convection	1	220 - 230	45 - 50	
Roast veal	2	Supercook/Fan Assisted	2	180 - 190	90 - 100	
Pork	2	Supercook/Fan Assisted	2	180 - 190	70 - 80	
Sausages	1.5	Fan grill	4	280	15	
Roast beef	1	Supercook/Fan Assisted	2	200	40 - 45	
Roast rabbit	1.5	Fan forced/Fan Assisted	2	180 - 190	70 - 80	
Turkey breast	3	Supercook/Fan Assisted	2	180 - 190	110 - 120	
Roast pork neck	2 - 3	Supercook/Fan Assisted	2	180 - 190	170 - 180	
Roast chicken	1.2	Supercook/Fan Assisted	2	180 - 190	65 - 70	
					1 st surface	2 nd surface
Pork chops	1.5	Fan grill	4	280	15	5
Spare ribs	1.5	Fan grill	4	280	10	10
Bacon	0.7	Grill	5	280	7	8
Pork fillet	1.5	Fan grill	4	280	10	5
Beef fillet	1	Grill	5	280	10	7
Salmon trout	1.2	Supercook/Fan Assisted	2	150 - 160	35 - 40	
Delicate fish	1.5	Supercook/Fan Assisted	2	160	60 - 65	
Flounder	1.5	Supercook/Fan Assisted	2	160	45 - 50	
Pizza	1	Supercook/Fan Assisted	2	280	8 - 9	
Bread	1	Fan forced/Fan Assisted	2	190 - 200	25 - 30	
Focaccia	1	Supercook/Fan Assisted	2	180 - 190	20 - 25	
Ring cake	1	Fan forced/Fan Assisted	2	160	55 - 60	
Tarts	1	Fan forced/Fan Assisted	2	160	35 - 40	
Ricotta cake	1	Fan forced/Fan Assisted	2	160 - 170	55 - 60	
Jam tarts	1	Supercook/Fan Assisted	2	160	20 - 25	
Paradise cake	1.2	Fan forced/Fan Assisted	2	160	55 - 60	
Profiteroles	1.2	Supercook/Fan Assisted	2	180	80 - 90	
Sponge cake	1	Fan forced/Fan Assisted	2	150 - 160	55 - 60	
Rice pudding	1	Supercook/Fan Assisted	2	160	55 - 60	
Brioche	0.6	Fan forced/Fan Assisted	2	160	30 - 35	

The times indicated in the table do not include preheating times and are provided as a guide only.



Cleaning and maintenance

4 Cleaning and maintenance

4.1 Instructions



Improper use

Risk of damage to surfaces

- Do not use steam jets to clean the appliance.
- Do not use cleaning products containing chlorine, ammonia or bleach on steel parts or parts with metallic finishes on the surface (e.g. anodizing, nickel- or chromium-plating).
- Do not use abrasive or corrosive detergents on glass parts (e.g. powder products, stain removers and metallic sponges).
- Do not use rough or abrasive materials or sharp metal scrapers.

Ordinary daily cleaning

Always use only specific products that do not contain abrasives or chlorine-based acids.

Pour the product onto a damp cloth and wipe the surface, rinse thoroughly and dry with a soft cloth or a microfibre cloth.

Food stains or residues

Do not use steel sponges or sharp scrapers as they will damage the surfaces.

Use ordinary non-abrasive products with the aid of wooden or plastic utensils if necessary. Rinse thoroughly and dry with a soft cloth or a microfibre cloth.

Do not allow residues of sugary foods (such as jam) to set inside the oven. If left to set for too long, they might damage the enamel lining of the oven.

4.2 Cleaning the appliance

To keep the surfaces in good condition, they should be cleaned regularly after use. Let them cool first.



We recommend the use of cleaning products distributed by the manufacturer.



4.3 Cleaning the door

Removing the door

For easier cleaning, the door can be removed and placed on a canvas.

To remove the door proceed as follows:

1. Open the door completely and insert two pins into the holes on the hinges indicated in the figure.

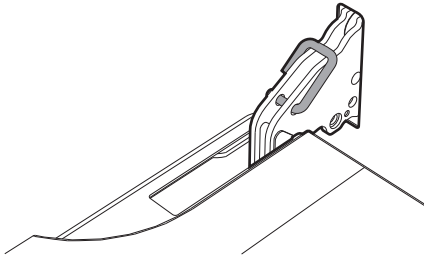

2. Grasp the door on both sides with both hands, lift it forming an angle of around 30° and remove it.

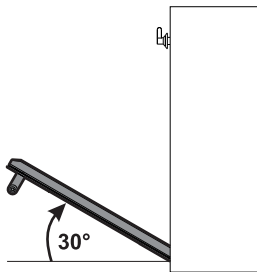

3. To reassemble the door, put the hinges in the relevant slots in the oven, making sure that grooved sections **A** are resting completely in the slots. Lower the door and once it is in place remove the pins from the holes in the hinges.

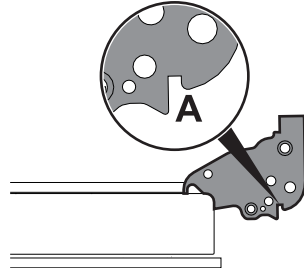

Cleaning the door glazing

The glass in the door should always be kept thoroughly clean. Use absorbent kitchen roll. In case of stubborn dirt, wash with a damp sponge and an ordinary detergent.



We recommend the use of cleaning products distributed by the manufacturer.



Cleaning and maintenance

Removing the internal glass panels

For easier cleaning, the internal glass panels of the door can be removed.

1. Remove the internal glass panel by pulling the rear part gently upwards, following the movement indicated by the arrows (1).
2. Then, pull the front part upwards (2). In this way, the 4 pins attached to the glass are released from their seats in the oven door.

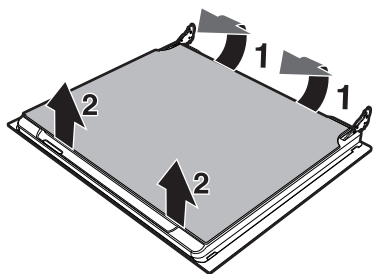

3. Some models have an intermediate glass panel. Remove the intermediate glass panel by lifting it upwards.

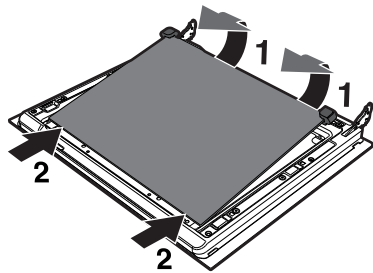

4. Clean the external glass panel and the panels removed previously. Use absorbent kitchen roll. In case of stubborn dirt, wash with a damp sponge and a neutral detergent.

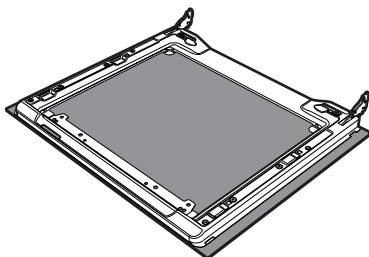

5. Refit the panels in the reverse order in which they were removed.
6. Reposition the internal glass panel. Take care to centre and secure the 4 pins into their seats in the oven door by applying slight pressure.

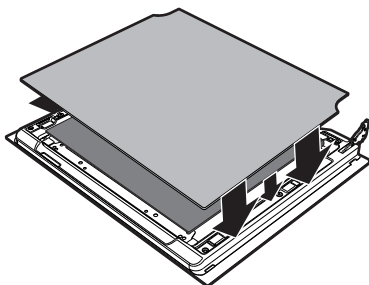



4.4 Cleaning the inside of the oven

Advice for cleaning the oven cavity

In order to keep your oven in the best possible condition, clean it regularly after letting it cool down.

Do not allow food residues to dry inside the oven cavity because doing so could damage the enamel.

Before cleaning, remove all the parts that can be removed.

For easier cleaning, it is recommended to remove:

- The door;
- The rack/tray support frames;
- The seal.



The oven should be operated at the maximum temperature for about 15-20 minutes after the use of specific products, to burn off the residues left inside the oven.



For easier cleaning, remove the door.

Removing rack/tray support frames

Removing the rack/tray support frames enables the sides to be cleaned more easily. This operation should be performed each time the automatic cleaning cycle is used (on some models only).

Removing the rack/tray support frames:

1. Pull the frame towards the inside of the oven cavity to unhook it from its groove **A**.
2. Then slide it out of the seats on the back **B**.
3. When cleaning is complete, repeat the above procedures to replace the rack/tray support frames.

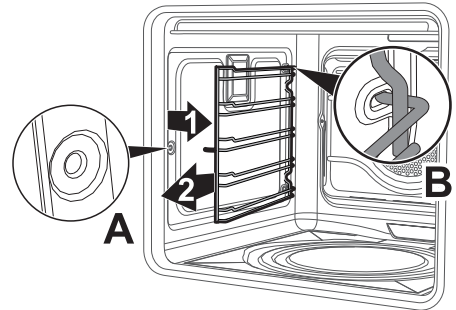



Cleaning and maintenance

Pyrolytic



The pyrolytic cycle is an automatic high-temperature cleaning procedure which causes dirt to dissolve. Thanks to this process, it is possible to clean the oven cavity very easily.



Improper use Risk of damage to surfaces

- Remove any food residues or large spills from previous cooking operations from the oven cavity.
- Switch off the burners or hot plates of the cooktop installed above the oven.



Preliminary operations

Before starting the Pyrolytic cycle:

- Clean the internal glass panel following the usual cleaning instructions.
- For very stubborn encrustations spray an oven cleaning product onto the glass (read the warnings on the product); leave for 60 minutes, then rinse and dry the glass using kitchen roll or a microfibre cloth.
- Completely remove all accessories from inside the oven.
- Remove the rack/tray support frames.
- Close the door.

Setting up the pyrolytic function

1. Turn the function knob to the **P** symbol.  Will appear on the display alternating with the minimum pyrolytic cycle time (2 hours).

2. Press the  or  button to set the duration of the cleaning cycle from a minimum of 2 hours to a maximum of 3 hours and 30 minutes.



Recommended pyrolytic cycle duration:

- Light dirt: 2 hours.
- Medium dirt: 2 hours 45 minutes.
- Heavy dirt: 3 hours 30 minutes.

3. Press the  button to confirm the start of the pyrolytic cycle.
4. One minute after the pyrolytic cycle has started, the door is locked (the door lock light lights up) by a device that prevents it from being opened.









It is not possible to select any function once the door lock device has been activated.

5. At the end of the pyrolytic cycle, all the numbers on the display will flash and a buzzer will sound to indicate the end of the automatic cleaning cycle.
6. Move the function knob back to the "0" position.
7. The door remains locked as long as the temperature inside the oven returns to safety levels.
8. Wait for the oven to cool down and collect the residues deposited inside with a damp microfibre cloth.



Setting of programmed pyrolytic cycle

It is possible to program the pyrolytic cycle start time like all other cooking functions.

1. After having started the pyrolysis cycle (see "Setting up the pyrolytic function"), press and hold the  button for 2 seconds.
2. Continue to press the  button until  appears on the display.
3. Press the  and  buttons within 5 seconds to set the time at which you want the cleaning cycle to end.
4. Press the  button to confirm the settings.



It is not possible to select any function once the door lock device has been activated. It remains possible, however, to switch off the appliance using the specific controls.

4.5 Extraordinary maintenance

Replacing the internal light bulb



Live parts
Danger of electrocution

- Unplug the appliance from the power supply.
1. Completely remove all accessories from inside the oven.
 2. Remove the rack/tray support frames.
 3. Remove the bulb cover using a tool (e.g. a screwdriver).



Be careful not to scratch the enamel on the side of the oven.

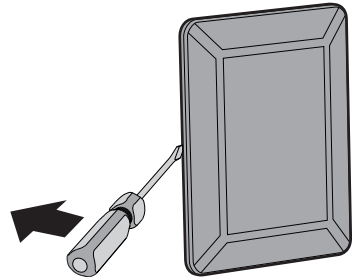



Cleaning and maintenance

- Slide the lamp out and remove it.

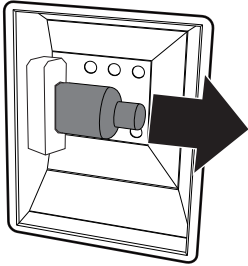

Do not touch the halogen lamp directly with your fingers, but hold it using insulating material.

- Replace the lamp with one of the same type (40W).
- Replace the bulb cover. Make sure that the inner shaped part of the glass (**A**) is facing the door.

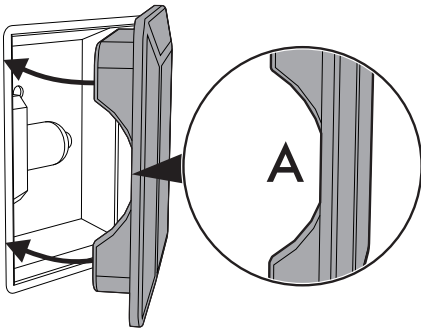

- Press the cover completely down so that it attaches perfectly to the bulb support.



5 Installation

5.1 Electrical connection



**Power voltage
Danger of electrocution**

- Have the electrical connection performed by authorised persons.
- The appliance must be connected to earth in compliance with electrical system safety standards.
- Disconnect the mains power supply.

General information

Check the grid characteristics against the data indicated on the plate.
The identification plate bearing the technical data, serial number and brand name is visibly positioned on the appliance.
Do not remove this plate for any reason.
The appliance works at 220-240 V \sim .
Use a three-pole cable (3 x 1.5 mm² internal conductors).
Make the ground connection using a wire that is 20 mm longer than the other wires.

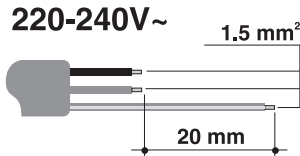

Fixed connection

Fit the power line with an omnipolar circuit breaker in compliance with installation regulations.

The circuit breaker should be located near the appliance and in an easily reachable position.

Connection with plug and socket

Make sure that the plug and socket are of the same type.

Avoid using adapters, gang sockets or extensions as these could cause overheating and a risk of burns.

Cable replacement



**Power voltage
Danger of electrocution**

- Disconnect the mains power supply.

1. Unscrew the rear casing screws and remove the casing in order to access the terminal board.

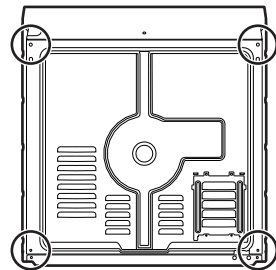

2. Replace the cable.
3. Make sure that the cables (for the oven or any cooktop) follow the best route in order to avoid any contact with the appliance.



Installation

5.2 Positioning



Heavy appliance
Crushing hazard

- Position the appliance into the cabinet cutout with the help of a second person.



Pressure on the open door
Risk of damage to the appliance

- Never use the oven door to lever the appliance into place when fitting.
- Avoid exerting too much pressure on the oven door when open.



Heat production during appliance operation
Risk of fire

- Check that the piece of furniture material is heat resistant.
- Check that the piece of furniture has the required slots.
- Do not install the appliance in a recess which can be closed with a door or in a cupboard.

Position of the power cable

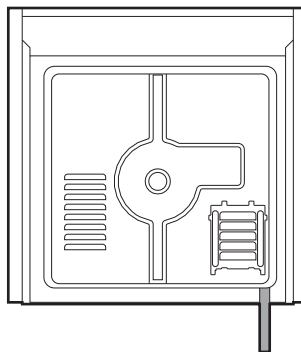

(rear view)

Front panel seal

Glue the seal provided to the rear of the front panel to prevent water or other liquids from leaking in.

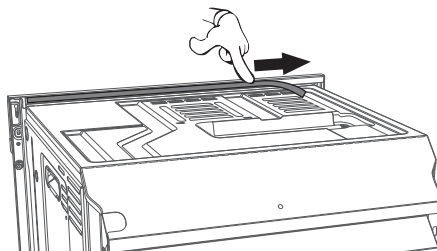



Fastening bushings

1. Remove the bushing covers inserted on the front of the appliance.

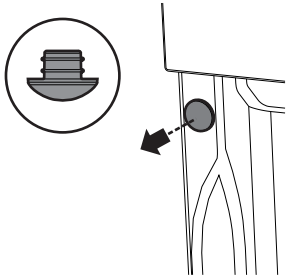

2. Mount the appliance into the recess.
3. Secure the appliance to the piece of furniture using the screws.

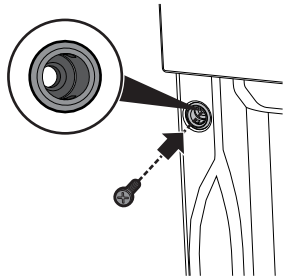

4. Cover the bushings using the covers that were previously removed.

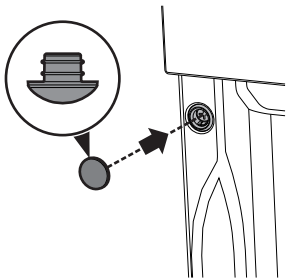

Appliance overall dimensions (mm)

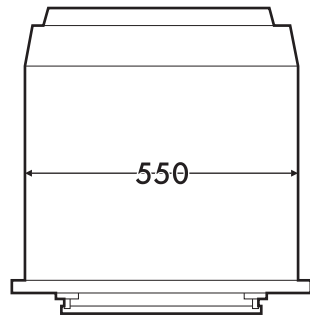
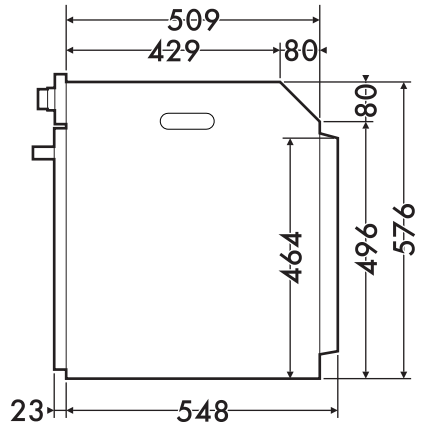
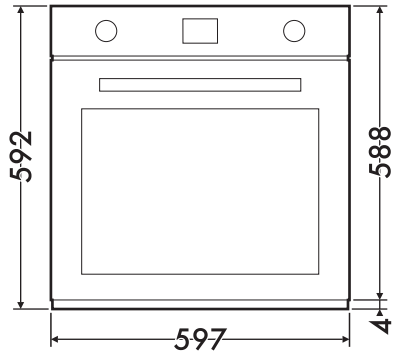



Installation

Mounting under worktops (mm)

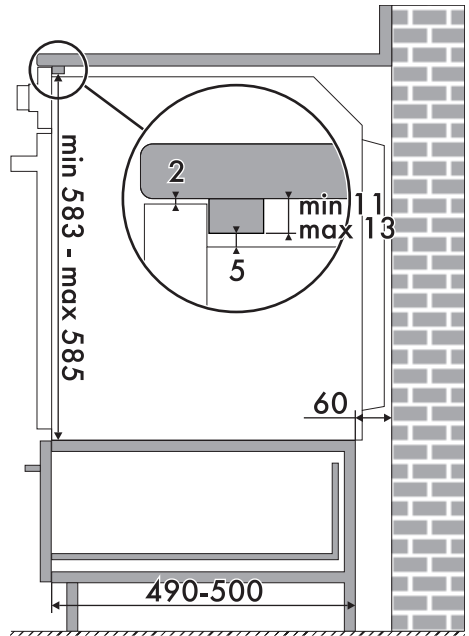
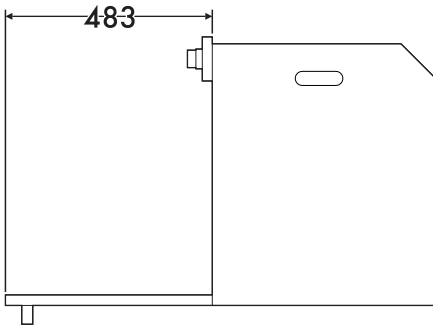
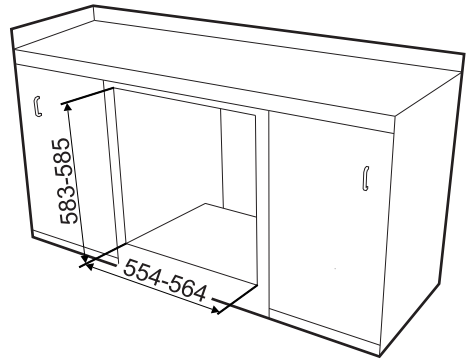
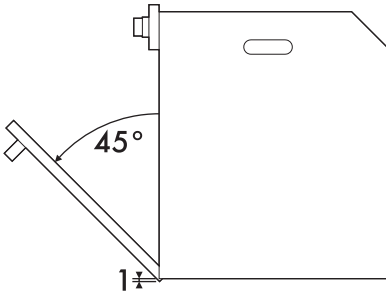

Make sure that the piece of furniture rear/bottom part has an opening of approx. 60 mm.



Mounting into a column (mm)

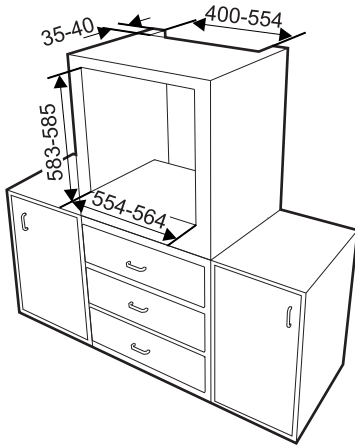

Make sure that the piece of furniture top/rear part has an opening approx. 35-40 mm deep.

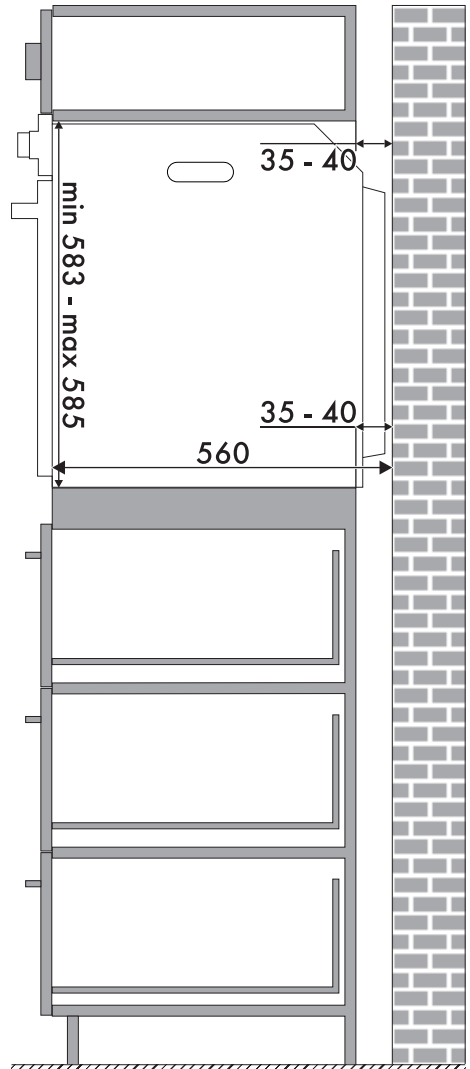

EN



914777583/B