

# Contents

<b>1</b>	<b>Instructions</b>	<b>4</b>
1.1	General safety instructions	4
1.2	Instructions for using microwaves	5
1.3	Manufacturer liability	7
1.4	Appliance purpose	7
1.5	Identification plate	7
1.6	Disposal	7
1.7	This user manual	8
1.8	How to read the user manual	8
<b>2</b>	<b>Description</b>	<b>9</b>
2.1	General Description	9
2.2	Control panel	10
2.3	Microwaves	11
2.4	Other parts	11
2.5	Available accessories	12
<b>3</b>	<b>Use</b>	<b>13</b>
3.1	Instructions	13
3.2	Materials suitable for microwaves	13
3.3	First use	15
3.4	Using the accessories	15
3.5	Using the oven	16
3.6	Special functions	29
3.7	Automatic programs	34
3.8	Secondary menu	37
<b>4</b>	<b>Cleaning and maintenance</b>	<b>40</b>
4.1	Instructions	40
4.2	Cleaning the surfaces	40
4.3	Cleaning the door glazing	41
4.4	Cleaning the oven cavity	41
4.5	Vapour Clean	43
<b>5</b>	<b>Installation</b>	<b>46</b>
5.1	Electrical connection	46
5.2	Positioning	47

## TRANSLATION OF THE ORIGINAL INSTRUCTIONS

We advise you to read this manual carefully, which contains all the instructions for maintaining the appliance's aesthetic and functional qualities.

For further information on the product: [www.smeg.com](http://www.smeg.com)



## 1 Instructions

### IMPORTANT SAFETY INSTRUCTIONS PLEASE READ CAREFULLY AND RETAIN FOR FUTURE USE.

#### 1.1 General safety instructions

##### Risk of personal injury

- **WARNING:** If the door or the door seal is damaged, the oven must not be used until it has been repaired by authorised persons.
- **WARNING:** It is hazardous for anyone other than a competent person to carry out any service or repair operation which involves the removal of a cover which offers protection against exposure to microwave energy.
- **WARNING:** Liquids and other foods must not be heated in sealed containers since they are liable to explode.
- **WARNING:** During use the appliance and its accessible parts become very hot.
- Never touch the heating elements during use.
- Keep children under eight years of age at a safe distance if they are not constantly supervised.
- This appliance may be used by children aged at least 8 and by people of reduced physical or mental capacity, or lacking in experience in the use of electrical appliances, as long as they are supervised or instructed by adults who are responsible for their safety.
- Children must never play with the appliance.
- The appliance must never be cleaned by unsupervised children.
- Switch off the appliance immediately after use.
- If smoke is emitted, switch off or unplug the appliance and keep the door closed in order to stifle any flames.
- Never attempt to extinguish a flame or fire with water.
- Have authorised persons carry out installation and assistance interventions according to the standards in force.
- Do not modify this appliance.
- Do not insert pointed metal objects (cutlery or utensils) into the slots in the appliance.



- Do not try to repair the appliance yourself or without the intervention of authorised persons.
- If the power supply cable is damaged, contact technical support immediately and they will replace it.

## Risk of damaging the appliance

- Do not use abrasive or corrosive detergents on glass parts (e.g. powder products, stain removers and metallic sponges).
- Use wooden or plastic utensils.
- Do not use steam jets to clean the appliance.
- Do not obstruct ventilation openings and heat dispersal slots.
- Never leave the appliance unattended during cooking operations where fats or oils could be released.
- Do not use the appliance to heat rooms for any reason.
- Do not rest any weight or sit on the open door of the appliance.
- Take care that no objects are stuck in the doors.

## 1.2 Instructions for using microwaves

- Check the appliance visually during the cooking of foods in plastic or paper containers.



Improper use  
Danger of explosion



- When using the microwave to heat or reheat liquids, the boiling process may be delayed – boiling temperature can be reached without the formation of the usual "rolling boil". This delayed boiling and consequent superheating of the liquid can generate an explosion inside the appliance, or sudden boiling over of the superheated liquid can occur when removing the container from the appliance. To avoid these dangers, it is necessary to insert the supplied boiling rod (or a heat-resistant plastic spoon) in the container while heating.
- Use the microwave only for the preparation of food for consumption. Other types of applications are strictly forbidden



## Instructions

- (e.g. drying clothes, warming slippers, sponges, wet cloths or the like, dehydrating foods) because they can lead to the risk of injury or fire.
- Clean the appliance constantly and remove any food residue.
  - Do not use the microwave to dry food.
  - Do not use the microwave to heat oils or fry.
  - Do not use the appliance to heat foods or beverages containing alcohol.
  - Baby food should not be heated in sealed containers. Remove the cover or the teat (in the case of baby bottles). Always check the preparation's temperature once heating has completed, it should not be too high. For an even temperature and to avoid scalding stir or shake the contents.
  - Do not heat eggs in their shells or whole hard boiled eggs; they may explode even after the heating process has completed.
  - Before cooking food with a hard skin or peel (e.g. potatoes, apples, etc.) it is necessary to puncture the skin.
  - Do not heat food contained within food packages.
  - Do not use the microwave functions when the oven is empty.
  - Use cookware and utensils that are suitable for use in a microwave oven.
  - Do not use aluminium containers to cook food.
  - Do not use dishes with metallic decorations (gold-plated or silver).
  - The appliance operates in the 2.4GHz ISM band.
  - In compliance with the provisions relating to electromagnetic compatibility the appliance belongs to group 2 and class B (EN 55011).
  - This appliance complies with the standards and directives currently in force concerning safety and electromagnetic compatibility. It is however recommended for pacemaker wearers to maintain a minimum distance of 20-30cm between the microwave when it is operating and the pacemaker. Consult the pacemaker manufacturer for more information.



## 1.3 Manufacturer liability

The manufacturer declines all liability for damage to persons or property caused by:

- Use of the appliance other than the one envisaged;
- Non-observance of the user manual provisions;
- Tampering with any part of the appliance;
- Use of non-original spare parts.

## 1.4 Appliance purpose

- This appliance is intended for cooking food in the home environment. Every other use is considered inappropriate. Moreover, it cannot be used:
  - in employee kitchens, shops, offices and other working environments.
  - in farms/agritourism establishments.
  - by guests in hotels, motels and residential environments.
  - in bed and breakfast establishments.
- The appliance is not designed to operate with external timers or with remote-control systems.

## 1.5 Identification plate

The identification plate bears the technical data, serial number and brand name of the appliance. Do not remove the identification plate for any reason.

## 1.6 Disposal



This appliance must be disposed of separately from other waste (Directives 2002/95/EC, 2002/96/EC, 2003/108/EC). The appliance does not contain substances in quantities sufficient to be considered hazardous to health and the environment, in accordance with current European directives.



### Power voltage Danger of electrocution

- Disconnect the main power supply.
- Disconnect the power cable from the electrical system.

To dispose of the appliance:

- Cut the power supply cable and remove it along with the plug (if present).
- Deliver the appliance to the appropriate recycling centre for electrical and electronic equipment waste, or return it to the retailer when purchasing an equivalent product, on a one for one basis.

Our appliances are packed in non-polluting and recyclable materials.

- Deliver the packing materials to the appropriate recycling centre.



### Plastic packaging Danger of suffocation

- Do not leave the packaging or any part of it unattended.
- Do not let children play with the packaging plastic bags.



# Instructions

## 1.7 This user manual

This user manual is an integral part of the appliance and must therefore be kept in its entirety and within the user's reach for the whole working life of the appliance.

- Read this user manual carefully before using the appliance.

## 1.8 How to read the user manual

This user manual uses the following reading conventions:

### Instructions



General information on this user manual, on safety and final disposal.

### Description



Description of the appliance and its accessories.

### Use



Information on the use of the appliance and its accessories, cooking advice.

### Cleaning and maintenance



Information for proper cleaning and maintenance of the appliance.

### Installation



Information for authorised persons: Installation, operation and inspection.



Safety instructions



Information



Advice

1. Sequence of instructions for use.

- Standalone instruction.



## 2 Description

### 2.1 General Description

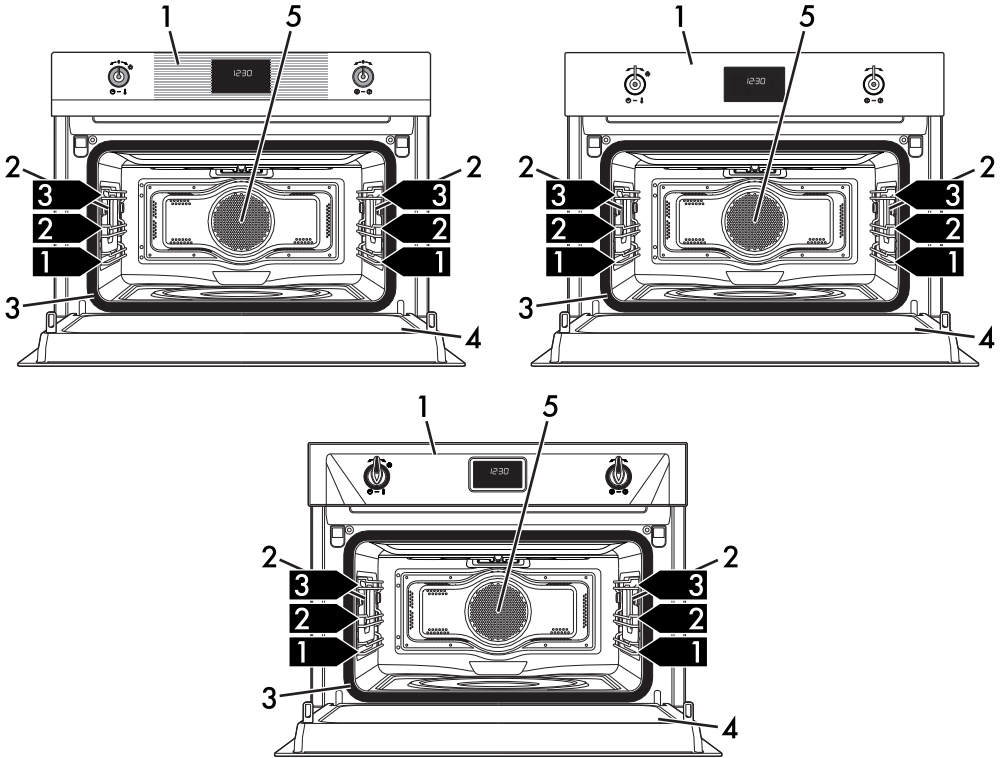

1 Control panel

2 Oven light

3 Seal

4 Door

5 Fan

**1,2,3** Frame shelf



# Description

## 2.2 Control panel

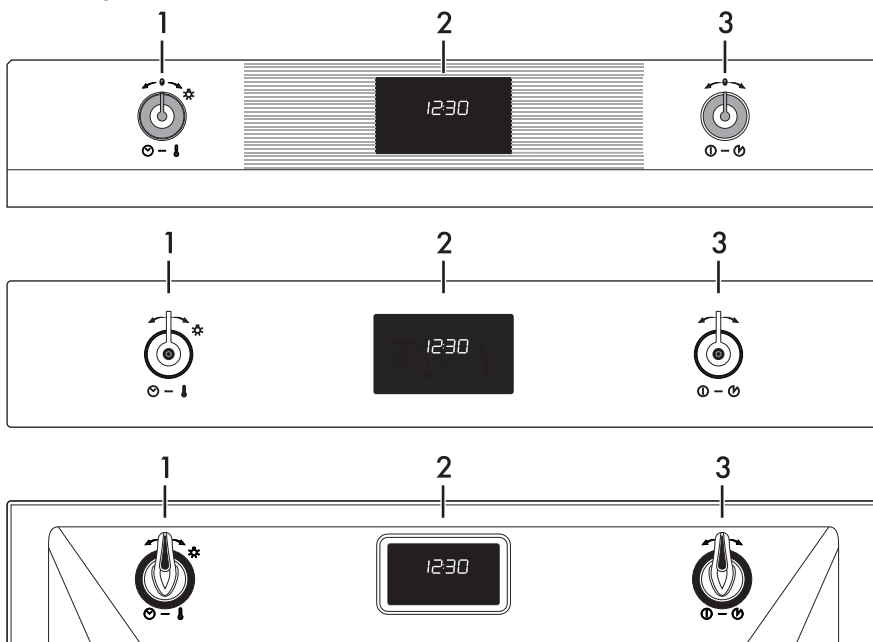

### 1 Temperature knob

This knob allows you to select:

- the microwave power level
- the cooking temperature
- the duration of a function
- programmed cooking
- the current time
- the switching on or off of the light inside the appliance.

### 2 Display

Displays the current time, the selected cooking function, power and temperature and any time that has been set.

### 3 Function knob

This knob can be used to:

- switch the appliance on/off,
- select a function,
- temporarily start or stop a function.





## 2.3 Microwaves

The appliance is equipped with a microwave generator called a magnetron. The microwaves generated are evenly emitted into the oven cavity in order to reach the food and heat it.

Heating takes place through the process of friction between the molecules contained within the food (mainly water molecules), with the consequent generation of heat.

The heat generated directly inside the food leads to defrosting, re-heating or cooking in a shorter length of time compared to traditional cooking.

The use of suitable containers for microwave cooking allows the microwaves to reach the food in a uniform manner (see 3.2 Materials suitable for microwaves).

## 2.4 Other parts

### Shelves

The appliance features shelves to position trays and racks at different heights. The insertion heights are indicated from the bottom upwards (see 2.1 General Description).

## Cooling fan

The fan cools the appliance and comes into operation during cooking.

The fan causes a steady outflow of air from above the door which may continue for a brief period of time even after the appliance has been turned off.

## Interior lighting

The appliance's interior lighting comes on:

- When the door is opened
- When any function is selected, apart

from the **ECO**  and **Vapour**

**Clean**  functions.

- When the temperature knob is turned briefly to the right (manual activation and deactivation).



When the door is open, it is not possible to turn off the interior lighting.



## Use

### 2.5 Available accessories

#### Boiling rod



To be placed in containers when heating liquids, necessary to avoid delayed boiling with resulting superheating.

#### Rack

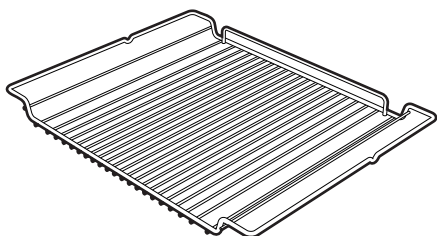

Useful for supporting containers with food during cooking.

#### Glass dish

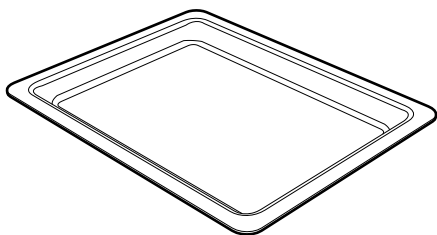

Useful for any type of cooking and collecting fat from foods resting on the rack above.

#### Tray rack

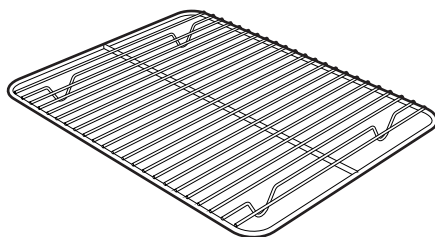

To be placed over the top of the oven tray; for cooking foods which may drip.

**i** Some models are not provided with all accessories.

**i** The oven accessories intended to come into contact with food are made of materials that comply with the provisions of current legislation.

**i** Original supplied and optional accessories can be requested to Authorised Assistance Centres. Use only original accessories supplied by the manufacturer.



## 3 Use

### 3.1 Instructions



**High temperature inside the oven cavity during use**  
**Danger of burns**

- Keep the oven door closed during cooking.
- Protect your hands by wearing heat resistant gloves when handling food inside the oven cavity.
- Do not touch the heating elements inside the oven cavity.
- Do not pour water directly onto very hot trays.
- Do not allow children to get close to the appliance when it is in operation.



**Improper use**  
**Risk of damage to enamelled surfaces**

- Do not cover the bottom of the oven cavity with aluminium or tin foil sheets.
- If you wish to use greaseproof paper, place it so that it will not interfere with the hot air circulation inside the oven cavity.
- Do not bang or drag kitchenware over the glazed bottom of the oven compartment.
- Do not pour water directly onto very hot trays.



**High temperature inside the oven cavity during use**  
**Danger of fire or explosion**

- Do not spray any spray products near the appliance.
- Do not use or leave flammable materials near the appliance.
- Do not use plastic kitchenware for cooking food (except with the microwave function).
- Do not put sealed tins or containers in the oven cavity.
- Do not leave the appliance unattended during cooking operations in which fats or oils could be released.
- Remove all trays and racks that are not required during cooking.

### 3.2 Materials suitable for microwaves

In general, in order for all of the food to be reached, the materials used for microwave cooking must be transparent to microwave energy.

Below is a table of materials to use and those not to use:



## Use

### MATERIALS TO USE:

#### - Glass (always remove lids) \*

- Baking dishes
- Glasses
- Jars

#### - Porcelain

#### - Terracotta

#### - Plastic (only if suitable for microwave use) \*

- Containers
- Plastic wrap (must not come into contact with the food)

\* only if heat-resistant.

### MATERIALS NOT TO BE USED:

#### Metals (these can generate arcs or sparks)

- Aluminium foil
- Aluminium trays
- Plates
- Metal utensils
- Freezer bags ties

#### - Wood

#### - Crystal glasses

#### - Paper (fire hazard)

#### - Polystyrene containers (food contamination hazard)



Dishes must be free of metal decorations.



Do not use metal accessory trays with microwave or combined microwave functions.

### Testing dishes



The microwave function can be used without any food inside the oven only for this test.

To check whether or not kitchenware is suitable for use with microwave cooking carry out this simple test:

1. Remove all accessories from the oven cavity.
2. Place the kitchenware to be tested on the rack on the first shelf.
3. Select the maximum power level (e.g. 1000W).
4. Set a cooking time of 30 seconds.
5. Start cooking.



#### Unsuitable kitchenware Risk of damage to the appliance

- If there is crackling or if sparks are emitted from the kitchenware then immediately terminate the test. In this instance the kitchenware is not suitable for microwave cooking.
6. At the end of the test the kitchenware must be either cold or slightly warm. If the kitchenware is hot then it should be considered as unsuitable for microwave use.



### 3.3 First use

1. Remove any protective film from the outside or inside of the appliance, including accessories.
2. Remove any labels (apart from the technical data plate) from the accessories and from the oven cavity.
3. Remove and wash all the appliance accessories (see 4 Cleaning and maintenance).
4. Heat the empty oven at maximum temperature (using the traditional functions) so as to remove any manufacturing residues.



For the first reheating use a traditional function and not a microwave function.

### 3.4 Using the accessories

#### Tray rack

The tray rack has to be inserted into the tray. In this way fat can be collected separately from the food which is being cooked.

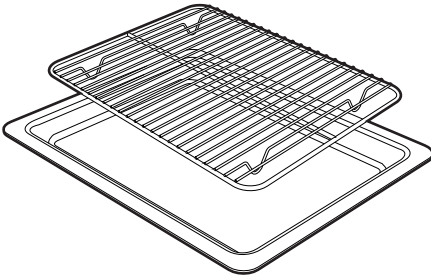

#### Racks and trays

Racks and trays have to be inserted into the side guides until they come to a complete stop.

- The mechanical safety locks that prevent the rack from being removed accidentally must face downwards and towards the back of the oven cavity.

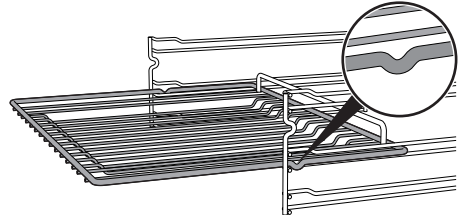

**High temperature  
Danger of burns**

- The accessory may become very hot. Always use heat-resistant gloves when handling it.



Gently insert the racks and trays as far as they will go into the oven cavity.



Clean the trays before using them for the first time to remove any residues left by the manufacturing process.



# Use

## Boiling rod



When using the microwave to heat or reheat liquids, the boiling process may be delayed while the liquids nevertheless exceed 100 degrees. To avoid this dangerous phenomenon, it is necessary to insert the supplied boiling rod (or a heat-resistant plastic spoon) in the container while heating.

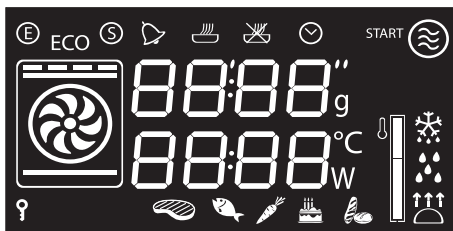

## 3.5 Using the oven

### Display



-  Eco-logic indicator light
-  Showroom indicator light
-  Minute minder timer indicator light
-  Timed cooking indicator light
-  Programmed cooking indicator light
-  Clock indicator light
-  Microwave indicator light
-  Defrost indicator light
-  Child lock indicator light



**Improper use**  
**Danger of explosion/burns**

- To avoid the risk of explosion inside the appliance or the sudden boiling over of superheated liquids, always immerse the boiling rod in the liquid that is being heated.



**High temperature**  
**Risk of damage to the accessory**

- Use the boiling rod only with Microwave functions. The rod must not be used with combined and traditional functions.



## Operating modes

**Stand-by:** When no function is selected, the display shows the current time.

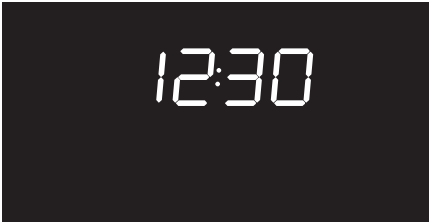

**ON:** When any function has been activated, the display shows the current parameters such as temperature, duration, microwave power and the temperature reached.

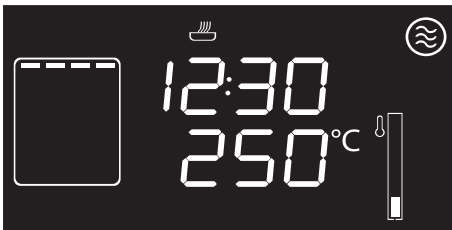

Each time the temperature knob is pressed during a function, it will cycle through the parameters in the following order.

The value can be changed in any mode by turning the temperature knob to the left or right. Keep the knob turned to produce a faster increase or decrease.

**If a microwave function has been activated:**



1. Microwave power level.
2. Function duration.

**If a Microwave + Grill function has been activated:**



1. Temperature.
2. Function duration.
3. Microwave power level.

**If a Grill function has been activated:**



1. Temperature
2. Minute minder timer duration.
3. Function duration.
4. Programmed cooking duration (if timed cooking has been selected).
5. Time display.



# Use

## Setting the time

On the first use, or after a power failure, **00:00** will flash on the appliance's display. The current time must be set in order for any cooking function to be started.

1. Turn the temperature knob to set the hour displayed (to increase or decrease it more quickly keep the knob turned to the right or left).
2. Press the temperature knob.
3. Turn the temperature knob to set the minutes (to increase or decrease it more quickly keep the knob turned to the right or left).
4. Press the temperature knob to complete the setting.



It may be necessary to change the current time, for example for daylight saving time. From stand-by mode, keep the temperature knob turned to the right or left until the hours flash.

It is not possible to change the time if the oven is **ON**.

## Microwave function



Improper use

**Risk of damage to the appliance**

When using the microwave functions, food must be placed in a suitable container on the rack inserted in the first runner.

**DO NOT USE CONTAINERS / ACCESSORIES (trays, glass dishes etc.) PLACED DIRECTLY ON THE FLOOR OF THE OVEN CAVITY.**

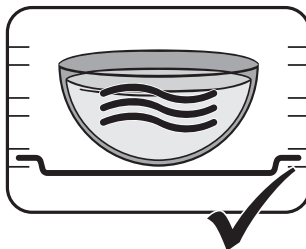
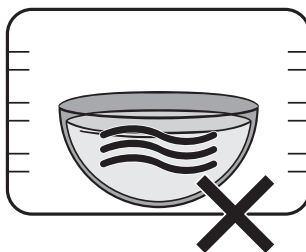

For perfect results with long microwave and combination cooking functions, food should be stirred once or twice during cooking.





## Microwaves

Given that they penetrate directly into the food, microwaves allow cooking to take place in a very short period of time and with a considerable saving of energy. They are suitable for cooking without fat and for defrosting and re-heating food while maintaining its original appearance and fragrance.

1. Turn the functions knob to select the microwave function .

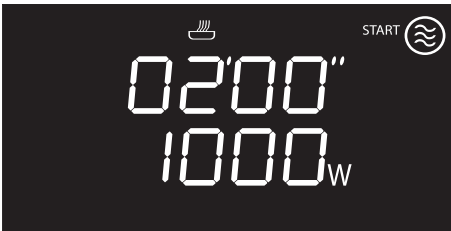

2. Press the temperature knob.
3. Turn the temperature knob to change the cooking time (max. 30 minutes).
4. Press the temperature knob.
5. Turn the temperature knob to change the power level from 100W to 1000W (see Microwave power levels).

6. Press the function knob to start microwave cooking.



The cooking function is stopped if the door is opened. Once the door is closed, press the function knob to resume cooking.



Press the function knob to pause the cooking function. Press it again to resume cooking.

7. At the end of the cooking time

**StoP** appears on the display and a buzzer sounds.





## Use

8. To deactivate the buzzer, press or turn one of the two knobs or open the door.



To deactivate the buzzer and select another timed cooking function, turn the temperature knob to the right.



To deactivate the buzzer and select a different cooking function, turn the function knob to the right or left.



Press and hold the function knob to switch off the appliance.

### Microwave power levels

Below is a list of the power levels that can be selected:

Power (W)	Useful for
100	Defrosting food
200	
300	
400	Cooking meat or delicate cooking
500	
600	
700	Re-heating and cooking food
800	
900	
1000	Heating liquids

### QUICK START microwave function



The QUICK START function allows the microwave to be started quickly. This is useful for heating small quantities of liquid or food.

1. From stand-by mode, press the function knob twice.

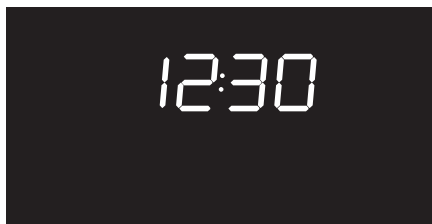

2. The appliance will start the microwave oven with the default settings.

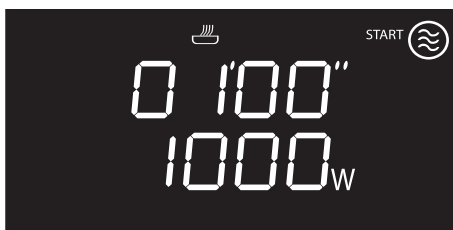



## Combined Functions



**Improper use**  
**Risk of damage to the appliance**

- Do not use the combined functions to heat or boil liquids.



Combination cooking is a mix of traditional cooking and microwave cooking. These functions are indicated by the traditional function symbol and the microwave function icon  turning on.

- Turn the function knob to select a combined function.

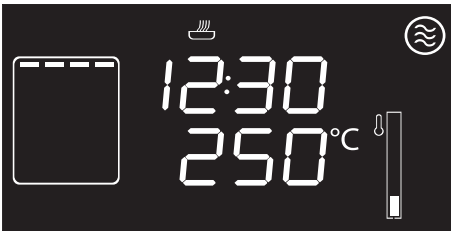

- Press the temperature knob.
- Turn knob to set the temperature.
- Press the temperature knob.
- Turn the temperature knob to change the cooking duration.
- Press the temperature knob.
- Turn the temperature knob to change the power level (from 100W to 700W).
- Press the function knob to start combination cooking.

## Pre-heating stage

The actual cooking is preceded by a preheating stage that allows the appliance to reach the cooking temperature more quickly.

The temperature reached indicator flashes to indicate that this stage is in progress.



When the preheating stage is complete, the temperature level reached indicator will remain on steadily and a buzzer sounds to indicate that the food can be placed inside the oven.



With the combination Microwave+Grill function, the oven is not preheated because of the type of cooking and to allow cooking to be carried out more quickly.



Cooking can be stopped at any time by pressing and holding the function knob for at least 3 seconds.



## Use

### Combination functions list



#### Microwave + Grill

The use of the grill results in perfect browning of the food's surface.



Using the microwave on the other hand leads to rapid internal cooking of the food.



#### Microwave + Static + fan

The operation of the fan, combined with traditional cooking, ensures consistent cooking even with complex recipes. Using the microwave on the other hand leads to rapid internal cooking of the food.



#### Microwave + Fan forced

For combination cooking of food in a short time thanks to the microwave action working together with hot air circulation.



### Traditional cooking functions

1. Select a cooking function using the function knob.

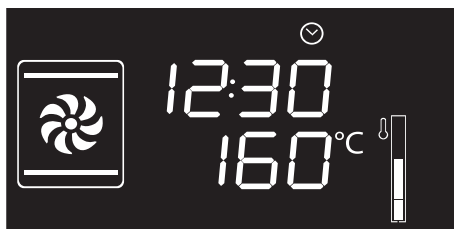

2. Press and turn the temperature knob to modify the cooking temperature.
3. Press the function knob to start traditional cooking.



To interrupt a function at any time, press and hold the function knob for at least 3 seconds.

### Pre-heating stage

The actual cooking is preceded by a preheating stage that allows the appliance to reach the cooking temperature more quickly.

The temperature reached indicator flashes to indicate that this stage is in progress.



When the preheating stage is complete, the temperature level reached indicator will remain on steadily and a buzzer sounds to indicate that the food can be placed inside the oven.





## Traditional functions list



### ECO

This function is particularly suitable for cooking on a single shelf with low power consumption.

Ideal when cooking meat, fish and vegetables. It is not recommended for foods that require proving.

To obtain maximum energy savings and reduce cooking times, it is recommended to place food in the oven without preheating the oven cavity.



When using the ECO function, avoid opening the door during cooking.



Cooking (and preheating) times are longer with the ECO function.



### Convection

As the heat comes from above and below at the same time, this system is particularly suitable for certain types of food. Traditional cooking, also known as static cooking, is suitable for cooking just one dish at a time. Perfect for all types of roasts, bread and cakes, and in any case, particularly suitable for fatty meats such as goose and duck.



### Grill

The heat coming from the grill element gives perfect grilling results above all for thin and medium thickness meat and, in combination with the rotisserie (where fitted), gives the food an even browning at the end of cooking. Perfect for sausages, spare ribs and bacon. This function enables large quantities of food, particularly meat, to be grilled evenly.



### Fan assisted

The operation of the fan, combined with traditional cooking, ensures consistent cooking even with complex recipes. Perfect for biscuits and cakes, even when cooked simultaneously on several levels. (For multiple-level cooking, we recommend using the 2<sup>nd</sup> and 4<sup>th</sup> shelves).



### Fan grill

The air produced by the fan reduces the intense heat generated by the grill, allowing even very thick foods to be grilled evenly. Ideal for large cuts of meat (e.g. pork shank).



## Baker's function

The combination of the fan with just the bottom heating element allows cooking to be completed more rapidly. This system is recommended for sterilising or for finishing to cook foods that are already well-cooked on the outside, but not on the inside and which therefore need a little more heat. Perfect for any type of food.



## Fan forced

The combination of the fan and the circular heating element (incorporated in the rear of the oven cavity) allows you to cook different foods on several levels, as long as they require the same temperatures and type of cooking. Hot air circulation ensures instant and even distribution of heat. It will be possible, for instance, to cook fish, vegetables and biscuits simultaneously (on different levels) without odours and flavours mingling.



## Supercook

The combination of fan assisted cooking and traditional cooking allows different foods to be cooked on several levels extremely quickly and efficiently, without odours and flavours mingling. Perfect for large volumes that call for intense cooking.

## Minute minder timer





This function only activates the buzzer, without stopping cooking.



The minute minder can be activated both during cooking and when the appliance is in standby.

1. Press the temperature knob once (twice if cooking is already in progress). The display shows **00:00** and the  indicator light flashes.



2. Turn the knob to set the duration (from 1 minute to 4 hours). After a few seconds, the  indicator light stops flashing and the countdown starts.
3. Select the required cooking function and wait for the buzzer to sound, indicating that the cooking time is over. The  indicator light flashes.



- To deactivate the buzzer, press or turn one of the two knobs.
- To select another minute minder, turn the temperature knob.



Set the value to zero in order to cancel the minute minder timer.

### Timed cooking



Timed cooking is the function which allows a cooking operation to be started and then ended after a specific length of time set by the user.



Activation of timed cooking cancels any minute minder timer which may previously have been set.

- After selecting a cooking function and a temperature, press the temperature knob three times. The display shows

**00:00**

and the  indicator light flashes.

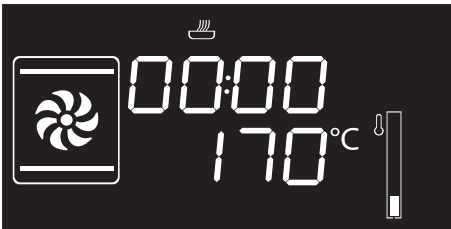

- Turn the temperature knob right or left to set the cooking duration from 00:01 to 12:59. Keep the knob turned to produce a faster increase or decrease.

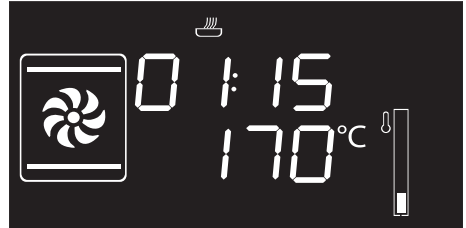

- A few seconds after the required duration is set, the  indicator light stops flashing and timed cooking starts.



To extend the cooking time manually, press the temperature knob again. The appliance will resume its normal operation with the previously selected cooking settings.

- At the end of the cooking time

**StoP**

appears on the display and a buzzer sounds.





## Use

5. To deactivate the buzzer, press or turn one of the two knobs or open the door.



To deactivate the buzzer and select another timed cooking function, turn the temperature knob to the right.





To deactivate the buzzer and select a different cooking function, turn the function knob to the right or left.



Press and hold the function knob to switch off the appliance.

### Modifying the data set during timed cooking

During operation, it is possible to modify timed cooking duration:

1. When the  indicator light is steady and cooking is in progress, press the temperature knob twice. The  indicator light starts flashing.
2. Turn the temperature knob right or left to change the previously set cooking duration.

### Programmed cooking



Programmed cooking is the function that allows cooking to be stopped automatically at an established time set by the user, after which the appliance will switch off automatically.

1. After selecting a cooking function and a temperature, press the temperature knob three times. The display shows



and the  indicator light flashes.

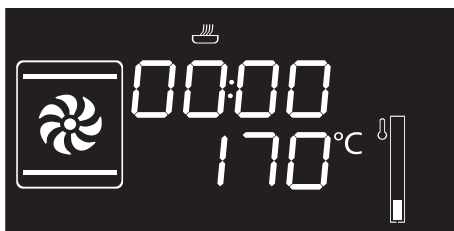

2. Turn the knob right or left to set the cooking duration from 00:01 to 12:59. Keep the knob turned to increase or decrease it more quickly.

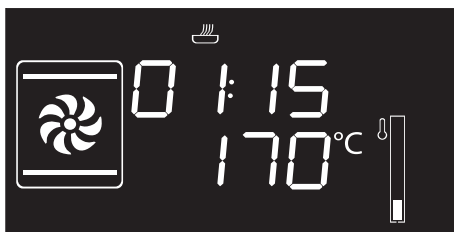







3. Press the temperature knob a fourth time.

The  indicator light flashes. Turn the knob right or left to set the cooking end time.

4. After a few seconds, the  and  indicator lights stop flashing. The appliance waits for the set start time.

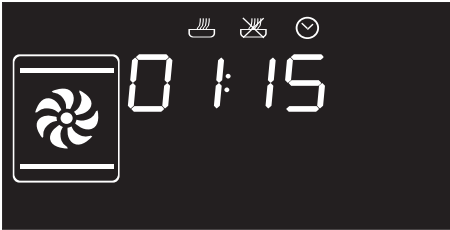

To extend the cooking time manually, press the temperature knob again. The appliance will resume its normal operation with the previously selected cooking settings.



With programmed cooking, the oven is switched on 10 minutes in advance to allow the appliance to reach the cooking temperature (preheating).

5. At the end of the cooking time **STOP** appears on the display and a buzzer sounds.

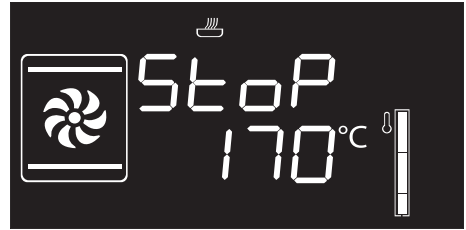

6. To deactivate the buzzer, press or turn one of the two knobs or open the door.



Press and hold the function knob to switch off the appliance.



For safety reasons, it is not possible to set the end of cooking time by itself without having set its duration.

### Modifying the data set during programmed cooking









After modifying the cooking duration, the end of cooking time must be re-set.

During operation, it is possible to modify programmed cooking duration:



## Use

1. Press the control knob when the  and  indicator lights are on steadily and the appliance is waiting to start cooking. The  indicator light starts flashing.
2. Turn the temperature knob right or left to change the previously set cooking duration.
3. Press the temperature knob again. The  indicator light switches off and the  indicator light starts flashing. The display shows the cooking end time.
4. Turn the temperature knob right or left to delay the cooking end time.
5. After a few seconds the  and  indicator lights stop flashing and programmed cooking resumes with the new settings.

### Traditional cooking tips

#### General advice

- Use a fan assisted function to achieve consistent cooking at several levels.
- It is not possible to shorten cooking times by increasing the temperature (the food could be overcooked on the outside and undercooked on the inside).

#### Advice for cooking meat

- Cooking times vary according to the thickness and quality of the food and to consumer taste.
- Use a meat thermometer when roasting meat, or simply press on the roast with a spoon. If it is hard, it is ready; if not, it needs another few minutes cooking.

#### Advice for cooking with the Grill and the Fan grill

- Meat can be grilled even when it is put into the cold oven or into the preheated oven if you wish to change the effect of the cooking.
- With the Fan grill function, we recommend that you preheat the oven before grilling.
- We recommend placing the food at the centre of the rack.



## Advice for cooking desserts/pastries and biscuits

- Use dark metal moulds: They help to absorb the heat better.
- The temperature and the cooking time depend on the quality and consistency of the dough.
- To check whether the dessert is cooked right through: At the end of the cooking time, put a toothpick into the highest point of the dessert. If the dough does not stick to the toothpick, the dessert is cooked.
- If the dessert collapses when it comes out of the oven, on the next occasion reduce the set temperature by about 10°C, selecting a longer cooking time if necessary.

## To save energy

- Stop cooking a few minutes before the time normally used. Cooking will continue for the remaining minutes with the heat which has accumulated inside the oven.
- Reduce any opening of the door to a minimum to avoid heat dispersal.
- Keep the inside of the appliance clean at all times.

## 3.6 Special functions

### Proving

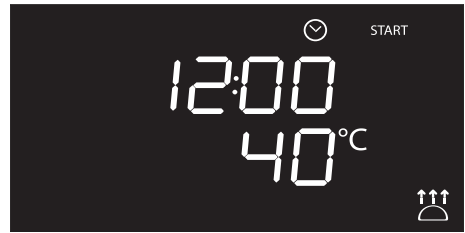

When using the proving function the temperature cannot be altered.



For successful proving, a container of water should be placed on the bottom of the oven cavity.

1. Position the dough to prove on the second level.
2. Press and turn the function knob to select the proving function . The text **START** flashes.
3. Press the function knob to start proving.
4. When finished **STOP** appears on the display and a buzzer sounds.



## Use

5. To deactivate the buzzer, press or turn one of the two knobs or open the door.
6. Press and hold the function knob for at least 3 seconds to exit from the function.

### Reheat



This function is used for re-heating food using microwaves that has been previously cooked and stored in the refrigerator.

1. Press the function knob to confirm the settings and start re-heating.



2. Press the temperature knob.
3. Turn the temperature knob to change the re-heating time.
4. Press the function knob to confirm the settings and start re-heating.

### Sabbath mode



This function allows food to be cooked in accordance with the provisions of the Jewish religion day of rest.



This function results in the appliance operating in a particular way:

- Cooking can carry on indefinitely; it is not possible to set a cooking duration.
- No preheating will be performed.
- The cooking temperature which can be selected varies between 60-100°C.
- The oven light remains off, any action such as opening the door or manually activating the oven does not turn the light on.
- The internal fan remains turned off.
- Knob illumination and audible prompts remain disabled.



After activating the Sabbath mode the settings cannot be altered.



Using the knobs will have no effect; only the function knob remains active to allow you to turn off the appliance.

1. Press and turn the function knob to select Sabbath mode **SAbb**.
2. Press and turn the temperature knob to modify the temperature of the function.
3. Press the temperature knob to confirm the set temperature. The text **START** flashes.
4. Press the function knob to start the Sabbath mode.
5. Press and hold the function knob for at least 3 seconds to exit from the function.

## Defrost by time



This function allows food to be defrosted using the microwave function according to a selectable time.

1. Place the food into the oven cavity (see "Turn" procedure)
2. Use the function knob to select the defrost by time function indicated by the  and  symbols.



3. Press the temperature knob to set the defrosting time.
4. Turn the knob to modify the defrosting time (from 5 seconds to 99 minutes).
5. Press the function knob to start defrosting.



If the selected defrost duration is more than 5 minutes, for best results, the food inside the oven compartment should be turned. See: "Turn" procedure

6. When finished **StoP** will flash on the display.



## Use

### Defrost by weight

**i** This function defrosts food according to the type and the weight of the frozen product.

1. Place the food into the oven cavity (see "Turn" procedure)
2. Press and turn the function knob to select the defrost by weight function indicated by **dE00** and the illuminated food symbols .

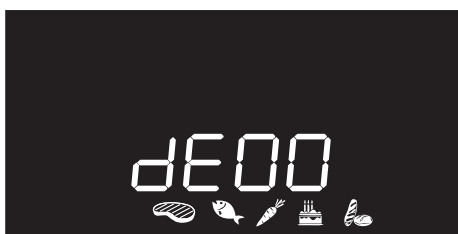





3. Press the function knob to confirm the defrost by weight function.
4. Turn the function knob to select the type of food to defrost.
5. Turn the temperature knob to select the weight (in grams) of the food to defrost.
6. Press the function knob to confirm the set parameters and start defrosting.

 For best results during defrosting the food in the oven should be turned. See: "Turn" procedure

7. When finished **StoP** appears on the display and a buzzer sounds.
8. To deactivate the buzzer, press or turn one of the two knobs or open the door.
9. Press and hold the function knob for at least 3 seconds to exit from the function.

### Pre-set parameters

dE	Type	Weight (g)	Time (min)*
01 	Meat	500	20
02 	Fish	400	17
03 	Fruit	300	15
04 	Bread	300	5

\* Defrosting times may vary according to the shape and size of the food to be defrosted.



## "Turn" procedure

For best defrosting results it is recommended, when necessary, to turn the dish inside the oven compartment.

1. Put the food in the oven, placing it parallel to the door.

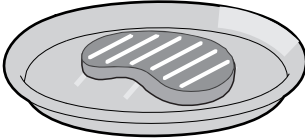

2. The food should be turned when **turn** appears on the display.

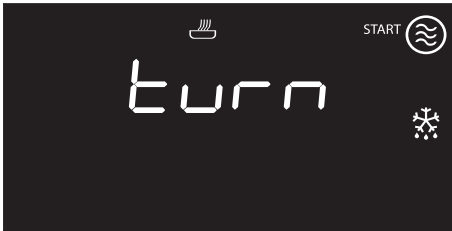

3. Open the door and turn the dish 90°.

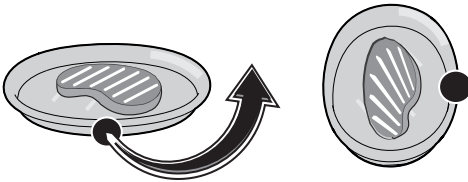

- i** If dish rotation is not performed the appliance will wait for one minute and then automatically continue defrosting. The word **turn** will be displayed beneath the countdown indicator as a reminder.

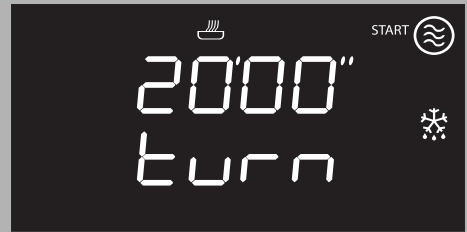

4. Close the door of the appliance and press the function knob to resume operation.
5. If necessary the appliance will again ask for rotation of the dish. The word **turn** will appear on the display.
6. For the second rotation the door will need to be opened and the dish turned by 180°.



7. Close the door and press the function knob to resume operation.



## 3.7 Automatic programs

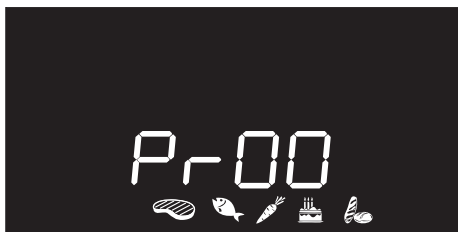

The automatic cooking programs are divided up according to the type of dish to be cooked.

1. Press and turn the function knob to select cooking with automatic programs, indicated by **Pr00** and the illuminated food symbols



2. Press the function knob to confirm cooking with automatic programs.
3. Turn the function knob to select the preferred program (see Automatic programs table).
4. Turn the temperature knob to select the weight (in grams) of the food to cook.

5. When preheating has finished, **START** will flash. Place the food to be cooked into the oven and press the function knob to start cooking.
6. When finished **Stop** appears on the display and a buzzer sounds.
7. To deactivate the buzzer, press or turn one of the two knobs or open the door.
8. Press and hold the function knob for at least 3 seconds to exit from the function.



Programmed cooking can be set when using automatic programs.



To interrupt a function at any time, press and hold the function knob for at least 3 seconds.











## Automatic programs table

EN

 MEAT (01 - 05)

Pr	Subcategory	Weight (g)	Level	Function	Temperature (°C)	Time (minutes)
01	Roast beef (medium)	1000	1		200	60
02	Pork loin	1000	1		190+300W	60
03	Lamb (medium)	1200	1		190+300W	60
04	Veal (roasted)	1000	1		190+300W	70
05	Roast chicken (whole)	1000	1		200+300W	50

 FISH (06 - 07)

Pr	Subcategory	Weight (g)	Level	Function	Temperature (°C)	Time (minutes)
06	Fresh (whole)	500	1		160+300W	30
07	Frozen	500	1		160+300W	40

 VEGETABLES (08 - 10)

Pr	Subcategory	Weight (g)	Level	Function	Temperature (°C)	Time (minutes)
08	Mixed grilled	500	3		250	15 + 10 <sup>(1)</sup>
09	Roasted	1000	2		220+300W	30
10	Chips (frozen)	500	2		220	13

<sup>(1)</sup> When grilling food, it is recommended to cook it on both sides, referring to the times indicated in the table. The longer length of time indicated always refers to the first side to be cooked, starting from the uncooked food.



## Use



### DESSERTS / PASTRIES (11 - 13)

Pr	Subcategory	Weight (g)	Level	Function	Temperature (°C)	Time (minutes)
11	Biscuits	600	1		160	18
12	Tarts	800	1		170	40



### BREAD - PIZZA - PASTA (14 -20)

Pr	Subcategory	Weight (g)	Level	Function	Temperature (°C)	Time (minutes)
13	Leavened bread (loaf)	1000	1		200	30
15	Pan baked pizza	1000	1		250	9
15	Pizza (frozen)	300	1		250	8
16	Pasta bake	2000	1		220	40
17	Lasagne (fresh)	2000	1		230	35
18	Lasagne (frozen)	300	1	+	230+500W	9
19	Quiche	1000	1		200	40
20	Soufflé	500	1		180	25

<sup>(2)</sup> (Models without Pizza stone) The stone must be placed on the bottom of the oven cavity. Frozen pizza cooked on the stone does not require different cooking times according to its weight.



The times indicated in the tables do not include preheating times and refer to cooking whole pieces. If the food has been cut into smaller portions, cooking times will decrease.



### 3.8 Secondary menu

The appliance has a drop-down secondary menu that allows the user to:

- Activate or deactivate the Child lock.
- Activate or deactivate Showroom mode (which disables all the heating elements so that only the control panel works).
- Activate or deactivate Low Power mode (Eco-Logic).
- Activate or deactivate timed light mode (Eco-Light).

With the appliance in Stand-By mode

1. Turn the temperature knob quickly to activate the internal light.
2. Press and hold the temperature knob for at least 5 seconds.
3. Turn the temperature knob right or left to change the mode setting (ON/OFF).
4. Press the temperature knob to move to the next mode.

### Child lock mode

This mode allows the appliance to lock the controls automatically after one minute of normal operation without any intervention from the user.

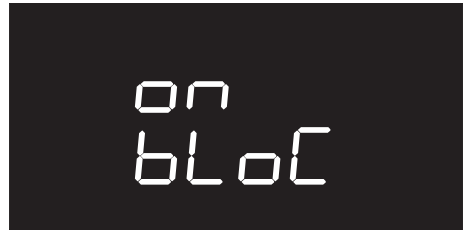
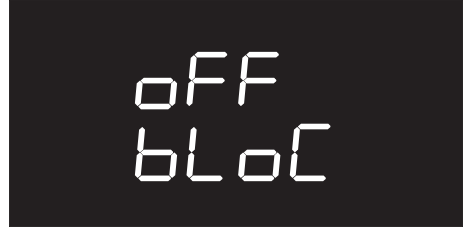

During normal operation, it is indicated by the  indicator light coming on.

To disable the lock temporarily during cooking, keep the temperature knob pressed for 5 seconds. One minute after the last setting the lock will become active again.



If the position of the knobs is changed, **bloC** will appear on the display for a few seconds.



Even with the child lock mode activated, the appliance can be turned off instantly by pressing the function knob for 3 seconds.



## Use

### Showroom mode (for exhibitors only)

This mode allows the appliance to deactivate all heating elements, while keeping the control panel active.



In order to use the appliance normally, set this mode to **OFF**.



**i** If the mode is active, the  indicator light lights up on the display.

### Low power mode

This mode allows the appliance to limit the power used.

Suitable for simultaneous use with further home appliances.

**HI**: normal power.

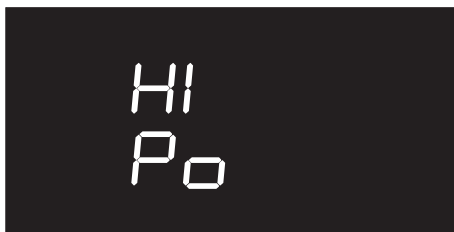

**LO**: low power.

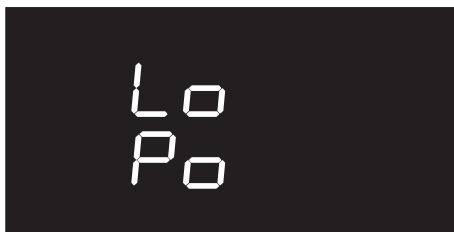

 Preheating and cooking times may be longer when low power mode is activated.

**i** If the mode is active, the  indicator light lights up on the display.



### Keep Warm Mode (some models only)

This mode allows the appliance to keep cooked food warm (at low temperatures) for approximately 1 hour after a cooking cycle finishes for which a duration has been set (if this is not manually interrupted).



### Timed light mode

For greater energy savings, the light is turned off automatically one minute after the start of cooking.



To prevent the appliance from turning off the light automatically after one minute set this mode to OFF.



The manual off/on control is always available with both settings by turning the temperature knob to the right.



# Cleaning and maintenance

## 4 Cleaning and maintenance

### 4.1 Instructions



**High temperature inside the oven cavity after use**  
**Danger of burns**

- Perform cleaning only after letting the appliance cool down.



**Improper use**  
**Risk of damage to surfaces**

- Do not use steam jets to clean the appliance.
- Do not use cleaning products containing chlorine, ammonia or bleach on steel parts or parts with metallic finishes on the surface (e.g. anodizing, nickel- or chromium-plating).
- Do not use abrasive or corrosive detergents (e.g. scouring powders, stain removers and metallic sponges) on glass parts.
- Do not use rough or abrasive materials or sharp metal scrapers.
- Failure to clean the oven cavity may shorten the life of the appliance and cause a hazard.
- Always remove food residues from the oven cavity.



**Improper use**  
**Danger of explosion/burns**

- Do not use detergents with high alcohol content or which can release inflammable vapours. Subsequent heating could set off an explosion inside the appliance.



If a lamp is damaged, contact Technical support for a replacement. This fault will not affect the integrity of the appliance which can continue to be used.

### 4.2 Cleaning the surfaces

To keep the surfaces in good condition, they should be cleaned regularly after use. Let them cool first.

#### Ordinary daily cleaning

Always use only specific products that do not contain abrasives or chlorine-based acids.

Pour the product onto a damp cloth and wipe the surface, rinse thoroughly and dry with a soft cloth or a microfibre cloth.



## Food stains or residues

Do not use metallic sponges or sharp scrapers as they will damage the surfaces.

Use ordinary non-abrasive products with the aid of wooden or plastic utensils if necessary. Rinse thoroughly and dry with a soft cloth or a microfibre cloth.

Do not allow residues of sugary foods (such as jam) to set inside the oven. If left to set for too long, they might damage the enamel lining of the oven.

## 4.3 Cleaning the door glazing

The glass in the door should always be kept thoroughly clean. Use absorbent kitchen roll. In case of stubborn dirt, wash with a damp sponge and an ordinary detergent.



We recommend the use of cleaning products distributed by the manufacturer.

## 4.4 Cleaning the oven cavity

In order to keep oven cavity in the best possible condition, clean it regularly after letting it cool down.

Avoid letting food residues dry inside the oven cavity as this could damage the enamel.

Take out all removable parts before cleaning.

To make cleaning easier, it is recommended to remove the rack/tray support frames.



If specific cleaning products are used, it is recommended to operate the oven at the maximum temperature for about 15-20 minutes in order to burn off any residues that may have been left inside the oven.

## Drying

Cooking food generates moisture inside the appliance. This is a normal phenomenon and does not affect the appliance's operation in any way.

Each time you finish cooking:

1. Let the appliance cool down.
2. Remove any dirt from inside the appliance.
3. Dry the interior of the appliance with a soft cloth.
4. Leave the door open until the inside of the appliance has dried completely.



## Cleaning and maintenance

### Removing racks/trays support frames

Removing the guide frames enables the sides to be cleaned more easily.

To remove the guide frames:

1. Unscrew the two fastening pins of the frame:

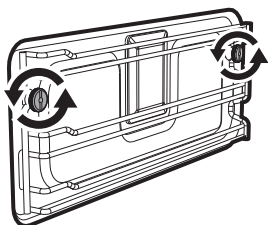

2. Pull the frame towards the inside of the oven cavity in order to release it from the fastening pins.

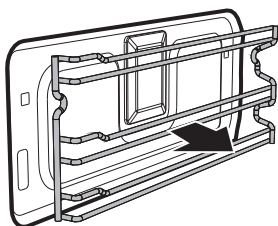

3. When cleaning is complete, repeat the above procedures to put the guide frames back in. Pay attention to the spacer bushings which need to be inserted correctly into the frames.

### Cleaning the top of the compartment



**High temperature inside the oven cavity during use  
Danger of burns**

- The following operations must be carried out only with the oven switched off and completely cool.

The appliance is equipped with a tilting grill element that allows for easy cleaning of the upper part of the oven compartment.

1. Free the upper heating element by gently lifting it and rotating its retaining latch by 90 degrees.

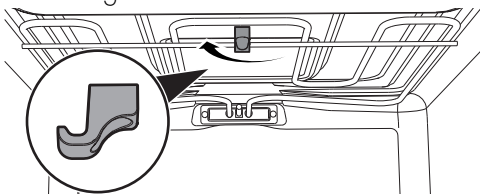

2. Gently lower the heating element until it stops.

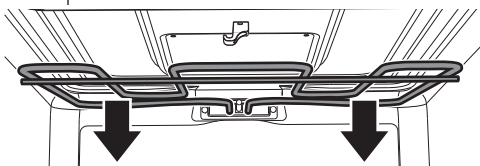

**Improper use  
Risk of damage to the appliance**

- Do not excessively flex the element during cleaning.

3. When you have finished cleaning, place the heating element back in position and turn the retaining latch to lock it in place.





## 4.5 Vapour Clean



Vapour Clean is an assisted cleaning procedure which facilitates the removal of dirt. This process makes it possible to clean the oven cavity very easily. The dirt residues are softened by the heat and water vapour for easier removal afterwards.



**Improper use**  
**Risk of damage to surfaces**

- Remove any food residues or large spills from previous cooking operations from the oven cavity.
- Carry out assisted oven cleaning operations only when the oven is cold.

### Preliminary operations

Before starting the Vapour Clean function:

- Remove all accessories from inside the oven. The upper guard can remain in the oven.

- Pour approximately 40cc of water onto the floor of the oven. Make sure it does not overflow out of the cavity.

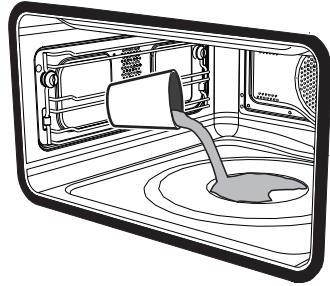

- Spray a solution of water and washing up liquid inside the oven using a spray nozzle. Direct the spray against the side walls, upwards, downwards and towards the deflector.

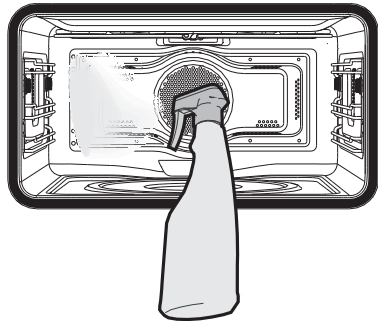

We recommend spraying approx. 20 times at the most.

- Close the door.



## Cleaning and maintenance

### Vapour Clean setting

**i** If the internal temperature is higher than that required for the Vapour Clean function, the cycle will be stopped immediately and **StoP** will appear on the display. Allow the appliance to cool down before activating the assisted cleaning cycle.

1. Press the function knob to select the Vapour Clean  function. The duration and temperature of the cleaning cycle will appear on the display.

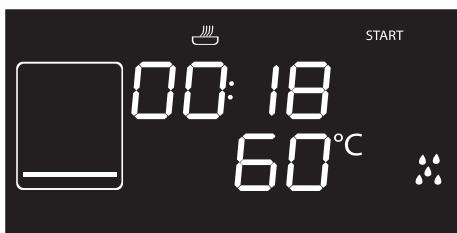

**i** The temperature parameters cannot be modified by the user.

2. Press the function knob to start the automatic cleaning cycle.

### Programmed Vapour Clean Cycle

Just like with normal cooking functions, it is also possible to set an end time for the Vapour Clean function.

1. After having selected the Vapour Clean function, press the temperature knob. The  indicator light starts flashing. The display shows the function end time.

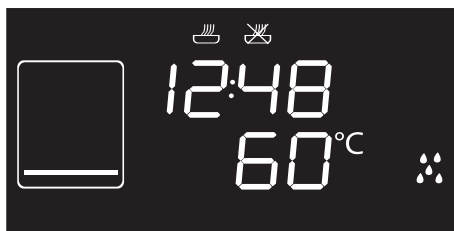

2. Turn the temperature knob right or left to delay the cooking end time.
3. Turn the temperature knob to confirm the function end time.
4. Press the function knob. The appliance waits for the set start time.

### End of the Vapour Clean cycle

When finished, **StoP** appears on the display and a buzzer will sound that can be deactivated by pressing the temperature knob.

1. Press and hold the function knob for at least 3 seconds to exit from the function.
2. Open the door and wipe away the less stubborn dirt with a microfibre cloth.



3. Use an anti-scratch sponge with brass filaments on tougher encrustations.
4. In case of grease residues use specific oven cleaning products.
5. Remove any remaining water from the oven cavity.

For improved hygiene and to prevent food being affected by unpleasant odours, we recommend that you dry the oven cavity using a fan assisted function at 160°C for approximately 10 minutes.



We recommend wearing rubber gloves for these operations.



For easier manual cleaning of the parts difficult to reach, we recommend removing the door.

## What to do if...

The display is completely off:

- Check the mains power supply.
- Check whether an all-pole switch upstream of the appliance supply line is in the "ON" position.

The appliance does not heat up:

- Check whether it has been set in "showroom" mode (for further details see 3.8 Secondary menu).

The controls do not respond:

- Check whether it has been set in "child lock" mode (for further details see "Secondary menu").

The cooking times are longer than those indicated in the table:

Check whether it has been set in "low power" mode (for further details see "Secondary menu").

If the door is opened during a fan assisted function, the fan stops:

- This is not a fault. It is a normal operation of the appliance, useful when cooking foods in order to avoid excessive heat escaping. When the door is closed, the oven will return to normal operation.



If the problem has not been resolved or in the case of other types of fault, contact your local technical support centre.



If other ERRx error messages are indicated:

Note down the error message, function and set temperature and contact your local technical support centre.



# Installation

## 5 Installation

### 5.1 Electrical connection



**Power voltage  
Danger of electrocution**

- Have the electrical connection performed by authorised persons.
- The appliance must be connected to earth in compliance with electrical system safety standards.
- Disconnect the mains power supply.

#### General information

Check the grid characteristics against the data indicated on the plate.

The identification plate bearing the technical data, serial number and brand name is visibly positioned on the appliance.

Do not remove this plate for any reason.

The appliance works at 220-240 V~.

Use a three-pole cable (3 x 1.5 mm<sup>2</sup> internal conductors).

Perform the ground connection using a wire that is 20 mm longer than the other wires.

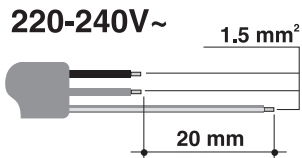

#### Fixed connection

Fit the power line with an all-pole circuit breaker in compliance with installation regulations.

The circuit breaker should be located near the appliance and in an easily accessible position.

#### Connection with plug and socket

Make sure that the plug and socket are of the same type.

Avoid using adapters and shunts as these could cause overheating and a risk of burns.

#### Cable replacement



**Power voltage  
Danger of electrocution**

- Disconnect the mains power supply.

1. Unscrew the rear casing screws and remove the casing to access the terminal board.
2. Replace the cable.
3. Make sure that the cables (for the oven or any cooktop) follow the best route in order to avoid any contact with the appliance.



## 5.2 Positioning



**Heavy appliance  
Crushing hazard**

- Position the appliance into the cabinet cutout with the help of a second person.



**Pressure on the open door  
Risk of damage to the appliance**

- Never use the oven door to lever the appliance into place when fitting.
- Avoid exerting too much pressure on the oven door when open.



**Heat production during appliance  
operation  
Risk of fire**

- Check that the piece of furniture material is heat resistant.
- Check that the piece of furniture has the required slots.
- Do not install the appliance in a recess which can be closed with a door or in a cupboard.

## Position of the power cable

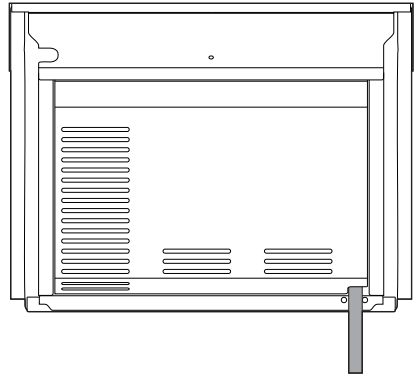

(rear view)

## Front panel seal

Glue the supplied seal to the rear part of the front panel to avoid water or other liquids from leaking in.

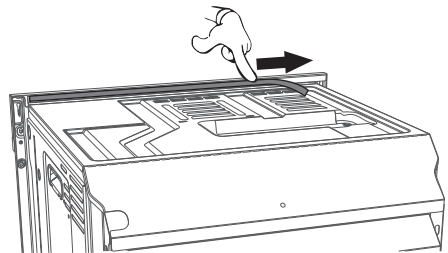



# Installation

## Fastening bushings

Remove the bushing covers from the front of the oven.

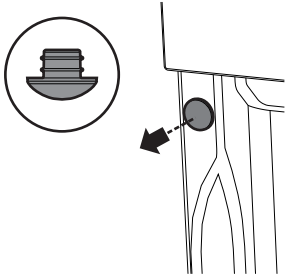

Mount the appliance into the recess.  
Secure the appliance to the piece of furniture using screws.

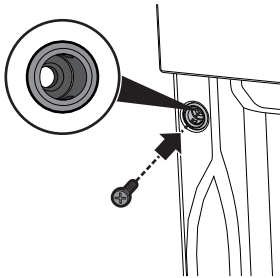

Cover the bushings with the covers removed previously.

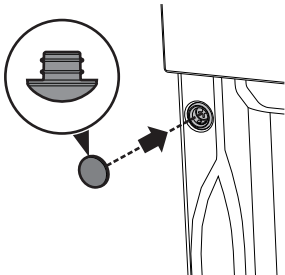

## Appliance overall dimensions (mm)

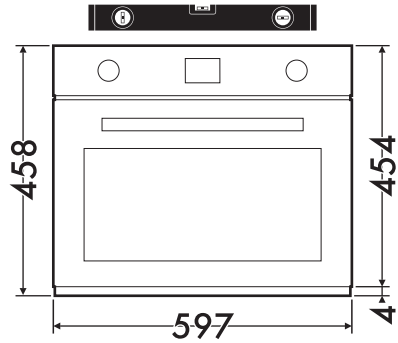

(front view)

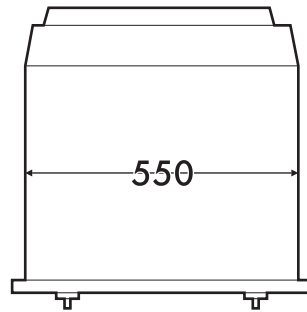

(top view)



## Mounting under worktops (mm)

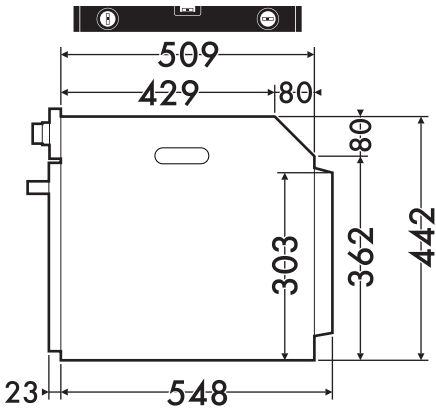

(side view)

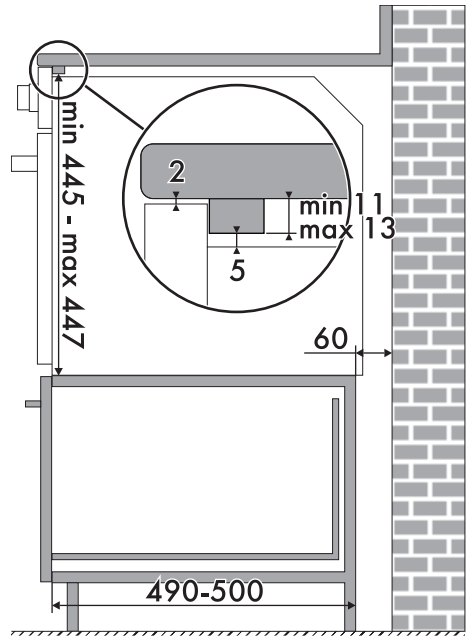
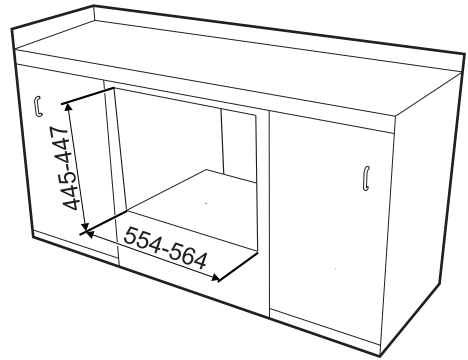
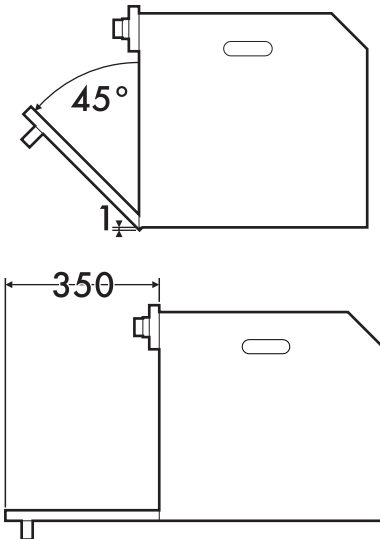

Make sure that the piece of furniture rear/bottom part has an opening of approx. 60 mm.



# Installation

## Mounting into a column (mm)

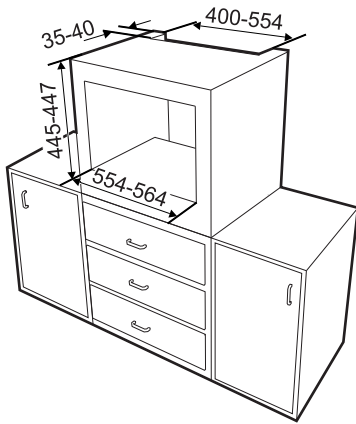

Make sure that the top/rear part of the piece of furniture has an opening approx. 35-40 mm deep.

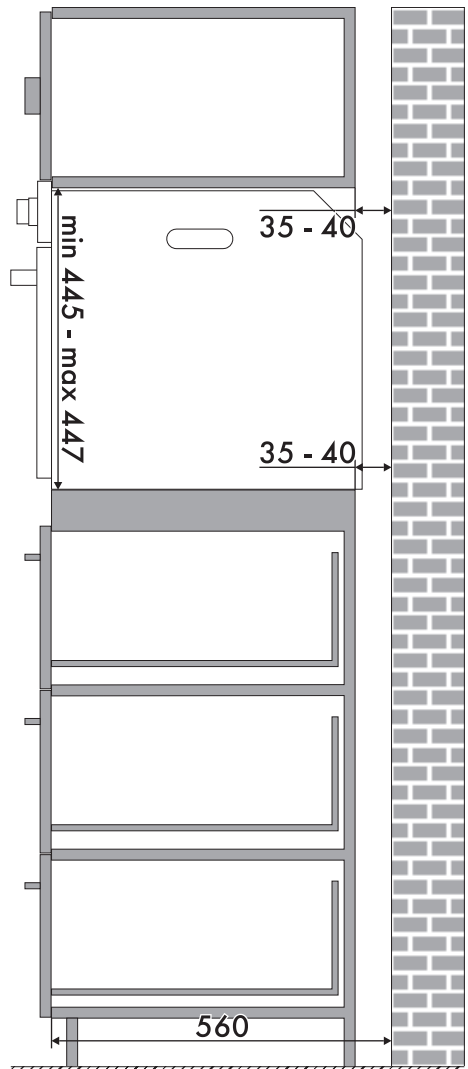

914777822/D