

Contents

1 Instructions	26
1.1 General safety instructions	26
1.2 Manufacturer liability	27
1.3 Appliance purpose	27
1.4 Disposal	27
1.5 Identification plate	28
1.6 This user manual	28
1.7 How to read the user manual	28
2 Description	29
2.1 General Description	29
2.2 Symbols	30
2.3 Available accessories	30
3 Use	31
3.1 Instructions	31
3.2 First use	31
3.3 Using the hob	32
4 Cleaning and maintenance	34
4.1 Instructions	34
4.2 Cleaning the appliance	34
5 Installation	36
5.1 Safety instructions	36
5.2 Section cut from the work surface	36
5.3 Mounting	37
5.4 Fixing brackets	38
5.5 Gas connection	38
5.6 Adaptation to different types of gas	40
5.7 Electrical connection	46

These instructions apply only for the destination countries listed on the appliance's data plate.
This is a class 3 built in hob.

We advise you to read this manual carefully, which contains all the instructions for maintaining the appliance's aesthetic and functional qualities.

For further information on the product: www.smeg.com



Instructions

1 Instructions

1.1 General safety instructions

Risk of personal injury

- During use the appliance and its accessible parts become very hot.
- Never touch the heating elements during use.
- Keep children under eight years of age at a safe distance if they are not constantly supervised.
- Children must never play with the appliance.
- Never rest metallic objects such as knives, forks, spoons and lids on the appliance during use.
- Switch the appliance off immediately after use.
- Never try to put out a fire or flames with water: turn off the appliance and smother the flames with a fire blanket or other appropriate cover.
- The appliance must never be cleaned by unsupervised children.
- Have qualified personnel carry out installation and assistance interventions according to the standards in force.
- Do not modify this appliance.
- Do not insert pointed metal objects (cutlery or utensils) into the slots in the appliance.

- Do not try to repair the appliance yourself or without the intervention of a qualified technician.
- If the power supply cable is damaged, contact technical support immediately and they will replace it.
- If cracks or fissures form, or if the glass ceramic cooking surface breaks, turn off the appliance immediately. Disconnect the power supply and call Technical Support.

Risk of damaging the appliance

- Do not use abrasive or corrosive detergents on glass parts (e.g. powder products, stain removers and metallic sponges).
- Use wooden or plastic utensils.
- Do not seat on the appliance.
- Do not use steam jets for cleaning the appliance.
- Do not obstruct ventilation openings and heat dispersal slots.
- Never leave the appliance unattended during cooking operations where fats or oils could be released.
- Never leave objects on the cooking surface.
- Do not use the appliance to heat rooms for any reason.



1.2 Manufacturer liability

The manufacturer declines all liability for damage to persons or property caused by:

- use of the appliance other than the one envisaged,
- non-observance of the user manual provisions,
- tampering with any part of the appliance,
- use of non-original spare parts.

1.3 Appliance purpose

This appliance is intended for cooking food in the home environment. Every other use is considered improper.

This appliance must not be used by people (including children) of reduced physical and mental capacity, or lacking in experience in the use of electrical appliances, unless they are supervised or instructed by adults who are responsible for their safety.

1.4 Disposal



This appliance must be disposed of separately from other waste (Directives 2002/95/EC, 2002/96/EC, 2003/108/EC). The appliance does not contain substances in quantities sufficient to be considered hazardous to health and the environment, in accordance with current European directives.

To dispose of the appliance:



Power voltage Danger of electrocution

- Disconnect the main power supply.
- Disconnect the power cable from the electrical system.
- Cut the power supply cable and remove it along with the plug.
- Consign the appliance to the appropriate selective collection centres for electrical and electronic equipment waste, or deliver it back to the retailer when purchasing an equivalent product, on a one for one basis.

Our appliances are packed in non-polluting and recyclable materials.

- Consign the packing materials to the appropriate selective collection centres.



Plastic packaging Danger of suffocation

- Do not leave the packaging or any part of it unattended.
- Do not let children play with the packaging plastic bags.



Instructions

1.5 Identification plate

The identification plate bears the technical data, serial number and brand name of the appliance. Do not remove the identification plate for any reason.

1.6 This user manual

This user manual is an integral part of the appliance and must therefore be kept in its entirety and in an accessible place for the whole working life of the appliance. Read this user manual carefully before using the appliance.

1.7 How to read the user manual

This user manual uses the following reading conventions:

Instructions



General information on this user manual, on safety and final disposal.

Description



Description of the appliance and its accessories.

Use



Information on the use of the appliance and its accessories, cooking advice.

Cleaning and maintenance



Information for proper cleaning and maintenance of the appliance.

Installation



Information for the qualified technician: installation, operation and inspection.



Safety instructions



Information



Advice

1. Use instruction sequence.
 - Single use instruction.



2 Description

2.1 General Description

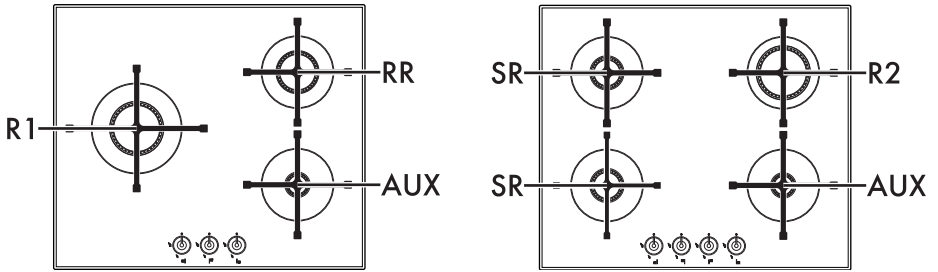

60 cm

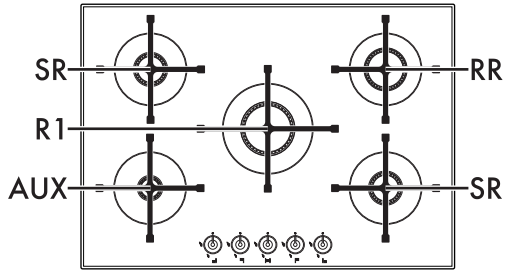

70 cm

AUX = Auxiliary
 SR = Semi-rapid
 RR = Reduced rapid

R1 = Large rapid
 R2 = Medium rapid



Description





2.2 Symbols

Cooking zones

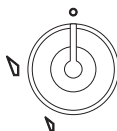
- Front left
- Rear left
- Central
- Rear right
- Front right
- Centre left

Burner knobs



Useful for lighting and adjusting the hob burners. Press and turn the knobs anti-clockwise to the value  to light the relative burners. Turn the knobs to the zone between the maximum  and minimum  setting to adjust the flame. Return the knobs to the  position to turn off the burners.

2.3 Available accessories

Burner wrench (for installer only)

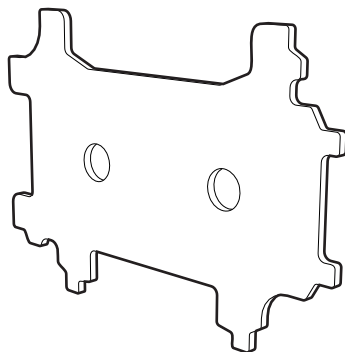

For removing and replacing the hob burners.

i Supplied and optional accessories can be requested to Authorised Assistance Centres. Use only original accessories supplied by the manufacturer.



3 Use

3.1 Instructions



Improper use Danger of burns

- Make sure that the flame-spreader crowns are correctly positioned in their housings with their respective burner caps.
- Oils and fat could catch fire if overheated. Be very careful.
- Do not leave the appliance unattended during cooking operations where fats or oils could be released.
- Do not spray any spray products near the appliance.
- Do not touch the appliance's heating elements when it is running. Leave them to cool before cleaning.
- Do not allow children younger than 8 years old to come near the appliance when in operation.



Improper use Risk of damage to surfaces

- Do not use aluminium foil to cover the burners or hob body.
- The cooking vessels or griddle plates should be placed inside the perimeter of the hob.
- All pans must have smooth, flat bottoms.
- If any liquid does boil over or spill, remove the excess from the hob.
- It is not advisable to use earthenware or stoneware pans to cook or heat food.

3.2 First use

1. Remove any protective film from the outside or inside of the appliance, including accessories.
2. Remove any labels (apart from the technical data plate) from accessories.
3. Remove and wash all the appliance accessories (see 4 Cleaning and maintenance).



3.3 Using the hob

All the appliance's control and monitoring devices are located together on the front panel. The burner controlled by each knob is shown next to the knob. The appliance is equipped with an electronic ignition device. Simply press the knob and turn it anti-clockwise to the maximum flame symbol, until the burner lights. If the burner does not light in the first 15 seconds, turn the knob to  and wait 60 seconds before trying again. After lighting, keep the knob pressed in for a few seconds to allow the thermocouple to heat up. The burner may go out when the knob is released: in this case, the thermocouple has not heated up sufficiently. Wait a few moments and repeat the operation. Keep the knob pressed in longer.



In case of an accidental switching off, a safety device will be tripped, cutting off the gas supply, even if the gas tap is open. Return the knob to  and wait at least 60 seconds before lighting it again.

Correct positioning of the grids

The grids over the burners must be positioned in parallel to the control panel, not perpendicular.

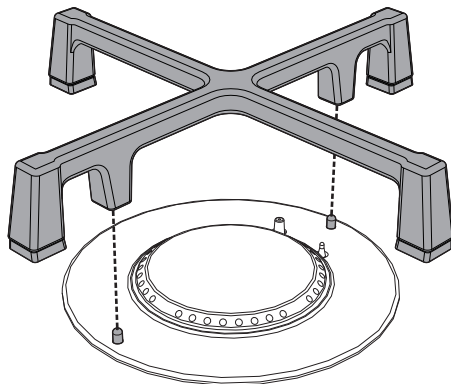

Correct positioning of the flame-spreader crowns and burner caps

Before lighting the hob burners, make sure that the flame-spreader crowns are correctly positioned in their housings with their respective burner caps. Make sure that the holes in the burners are aligned with the igniters and thermocouples. Also ensure that the flame-spreader crowns are correctly engaged in the burner holes.

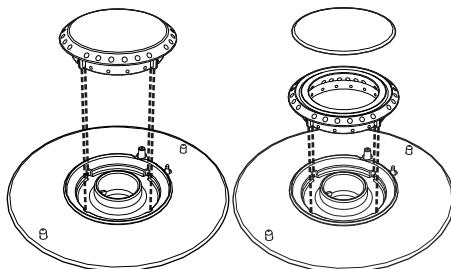



Practical tips for using the hob

For better burner efficiency and to minimise gas consumption, use pans with lids and of suitable size for the burner, so that flames do not reach up the sides of the pan. Once the contents come to the boil, turn down the flame far enough to ensure that the liquid does not boil over.



Cookware diameters:

- Auxiliary: 7 - 18 cm.
- Semi-rapid: 10 - 24 cm.
- Reduced rapid: 18 - 24 cm.
- Medium rapid: 20 - 26 cm.
- Large rapid: 20 - 26 cm.

To prevent burns or damage to the hob or the counter top during cooking, all pans or griddles must be placed inside the perimeter of the hob.

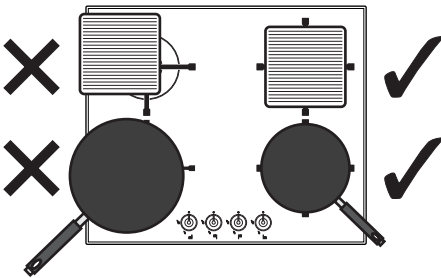

Limitations on griddle use

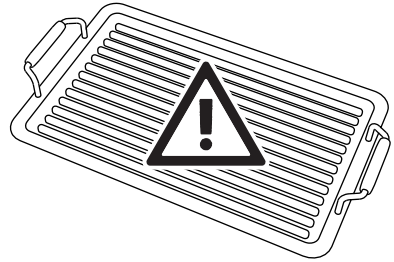

Improper use

Risk of damage to surfaces

- Do not use cast-iron griddles.

A few precautions are necessary if you wish to use a griddle:

- Use aluminium griddles, including those with anti-stick coating, with dimensions not to exceed 35 x 26 cm;
- Aluminium griddles with Teflon anti-stick coating should be pre-heated for a maximum of 5 minutes in order to avoid damage to the appliance and the Teflon coating. After pre-heating, place the foodstuffs on the griddle to cook them; do not exceed 40 minutes of total use for the griddle.
- Do not allow the burner flames to extend beyond the edge of the griddle;
- Leave a gap of at least 150 mm between the edge of the griddle and the side wall;
- Do not place the griddle over more than one burner at the same time.



4 Cleaning and maintenance

4.1 Instructions



Improper use

Risk of damage to surfaces

- Do not use steam jets for cleaning the appliance.
- Do not use cleaning products containing chlorine, ammonia or bleach on steel parts or parts with metallic finishes on the surface (e.g. anodizing, nickel- or chromium-plating).
- In case of contact with overly harsh detergents, hard water or spills (cooking water, sauce, coffee etc.), clean the hob as soon as it has cooled.
- Do not use abrasive or corrosive detergents on glass parts (e.g. powder products, stain removers and metallic sponges).
- Do not use rough or abrasive materials or sharp metal scrapers.
- Do not wash the removable components such as the hob pan stands, flame-spreader crowns and burner caps in a dishwasher.

4.2 Cleaning the appliance

To keep the surfaces in good condition, they should be cleaned regularly after use. Let them cool first.

Ordinary daily cleaning

Always use only specific products that do not contain abrasives or chlorine-based acids.

Pour the product onto a damp cloth and wipe the surface, rinse thoroughly and dry with a soft cloth or a microfibre cloth.

Food stains or residues

Do not use metallic sponges or sharp scrapers as they will damage the surfaces.

Use ordinary non-abrasive products with the aid of wooden or plastic utensils if necessary. Rinse thoroughly and dry with a soft cloth or a microfibre cloth.

Do not allow residues of sugary foods (such as jam) to set inside the oven. If left to set for too long, they might damage the enamel lining of the oven.



Cooking hob grids

Remove the grids and clean them with lukewarm water and non-abrasive detergent. Make sure to remove any encrustations. Dry them thoroughly and return them to the hob.

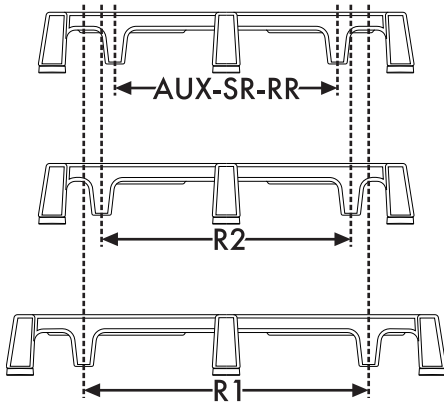

Continuous contact between the grids and the flame can cause modifications to the enamel over time in those parts exposed to heat. This is a completely natural phenomenon which has no effect on the operation of this component.

Flame-spreader crowns and burner caps

For easier cleaning, the flame-spreader crowns and the burner caps can be removed. Wash them in hot water and non-abrasive detergent. Carefully remove any encrustation, then wait until they are perfectly dry. Refit the flame-spreader crowns making sure that they are correctly positioned in their housings with their respective burner caps.

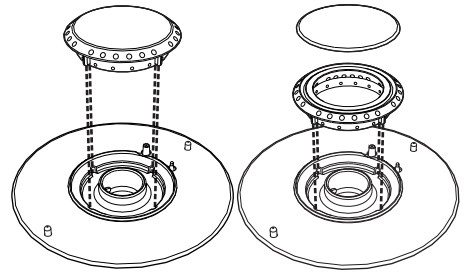

Igniters and thermocouples

For correct operation the igniters and thermocouples must always be perfectly clean. Check them frequently and clean them with a damp cloth if necessary. Remove any dry residues with a wooden toothpick or a needle.

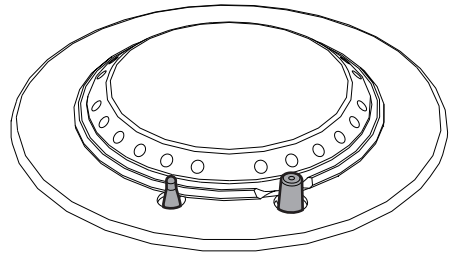



Installation

5 Installation

5.1 Safety instructions



Heat production during appliance operation

Risk of fire

- Check that the piece of furniture material is heat resistant.
- Check that the piece of furniture has the required slots.

Veneers, adhesives or plastic coatings on adjacent furniture should be temperature-resistant (>90°C), otherwise they might warp over time.



The minimum distance between a ventilation hood and the cooking surface must be at least the distance indicated in the ventilation hood installation instructions.

The minimum distances must also be respected for the edges of the hob on the back as indicated in the mounting illustrations.

5.2 Section cut from the work surface



The following operation requires building and/or carpentry work and must therefore be carried out by a competent tradesman.

Installation can be carried out on various materials such as masonry, metal, solid wood or plastic laminated wood as long as they are heat resistant (>90°C).

Create an opening with the dimensions shown in the figure in the work surface of the piece of furniture.

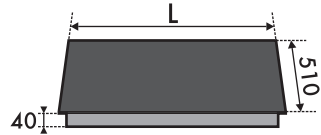

L (mm)	X (mm)	Y (mm)
600 - 720	560 ÷ 564	482 ÷ 486

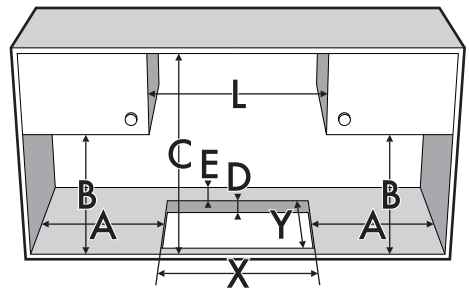

A (mm)	B (mm)	C (mm)	D (mm)	E (mm)
min 150	min 460	min 750	20 ÷ 60	min 50



5.3 Mounting

Over built-in oven

The distance between the hob and the kitchen furniture or other installed appliances must be enough to ensure sufficient ventilation and air discharge.

If installed above an oven, a space must be left between the bottom of the hob and the top of the appliance installed below.

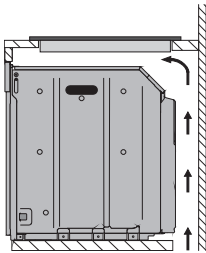

opens on bottom

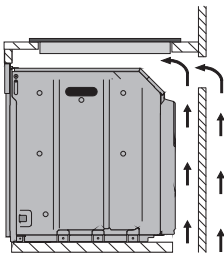

opens on bottom and on rear



If installed on top of an oven, the latter must be equipped with a cooling fan.

Over empty kitchen unit or drawers

If there are other pieces of furniture (side walls, drawers etc.), dishwashers or fridges under the hob, a double-layer wooden base must be installed at least **10 mm** from the bottom of the hob to avoid any accidental contact. It must only be possible to remove the double-layer base using suitable equipment.

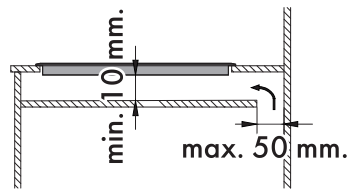
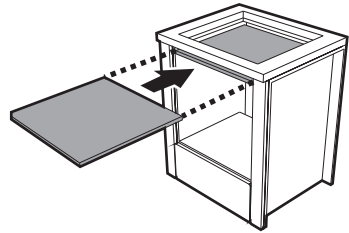

opens on bottom

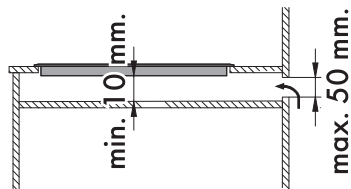

opens on rear



Failure to install the double-layer wooden base exposes the user to possible accidental contact with sharp or hot parts.



Installation

Hob seal

To prevent leakage of liquid between the frame of the hob and the work surface, place the adhesive seal provided along the entire outer edge of the hob before assembly.

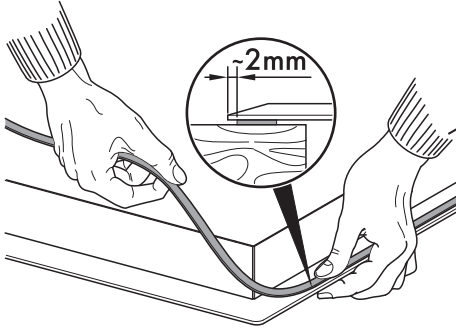

Do not use silicone to secure the hob. This would make it impossible to remove the hob, if necessary, without damaging it.

5.4 Fixing brackets

Screw the fixing brackets (**A**) into the holes on the sides of the bottom casing to properly fasten the hob to the structure.

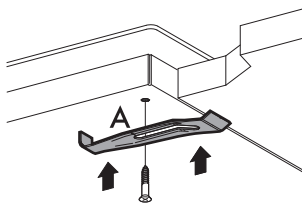

5.5 Gas connection



**Gas leak
Danger of explosion**

- After carrying out any operation, check that the tightening torque of gas connections is between 10 Nm and 15 Nm.
- If required, use a pressure regulator that complies with current regulations.
- At the end of the installation, check for any leaks with a soapy solution, never with a flame.
- The hoses should not come into contact with moving parts and should not be crushed in any way.

General information

Connection to the gas mains can be made using a rigid copper pipe or a continuous wall flexible steel hose in compliance with the provisions established by the applicable standard.

For supplying it with other types of gas, see chapter "5.6 Adaptation to different types of gas". The gas inlet connection is threaded 1/2" external gas (ISO 228-1).

Connection with a flexible steel hose

Make the connection to the gas mains using a continuous wall flexible steel hose whose specifications comply with the applicable standard.



Carefully screw the connector **3** to the gas connector **1** of the appliance, placing the seal **2** between them.

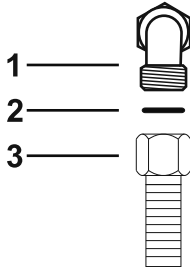

Connection with a flexible steel hose with conical fitting

Make the connection to the gas mains using a continuous wall flexible steel hose whose specifications comply with the applicable standard.

Carefully screw the hose connector **3** to the appliance's gas connector **1** ($\frac{1}{2}$ " thread ISO 228-1), placing the supplied seal **2** between them. Apply insulating material to the thread of connector **3**, then tighten the flexible steel hose **4** to the connector **3**.

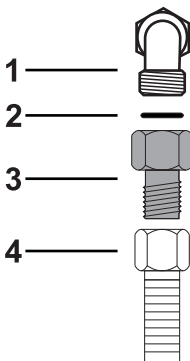

Connection to LPG

Use a pressure regulator and make the connection on the gas cylinder following the guidelines set out in the regulations in force.

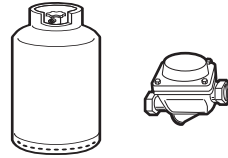

The supply pressure must comply with the values indicated in the table in "Gas types and Countries".

Room ventilation

The appliance should be installed in rooms that have a permanent air supply in accordance with the standards in force. The room where the appliance is installed must have enough air flow needed for the regular combustion of gas and the necessary air change in the room itself. The air vents, protected by grilles, must be the right size to comply with current regulations and positioned so that no part of them is obstructed, not even partially.

The room must be kept adequately ventilated in order to eliminate the heat and humidity produced by cooking: in particular, after prolonged use, you are recommended to open a window or to increase the speed of any fans.



Installation

Extraction of the combustion products

The combustion products may be extracted by means of hoods connected to a natural draught chimney whose efficiency is certain or via forced extraction. An efficient extraction system requires precision planning by a specialist qualified in this area and must comply with the positions and distances indicated by the applicable standards.

When the job is complete, the installer must issue a certificate of conformity.

- 1 Extraction using a hood
- 2 Extraction without a hood

- A Single natural draught chimney
- B Single chimney with extractor fan
- C Directly outdoors with wall- or window-mounted extractor fan
- D Directly outdoors through wall

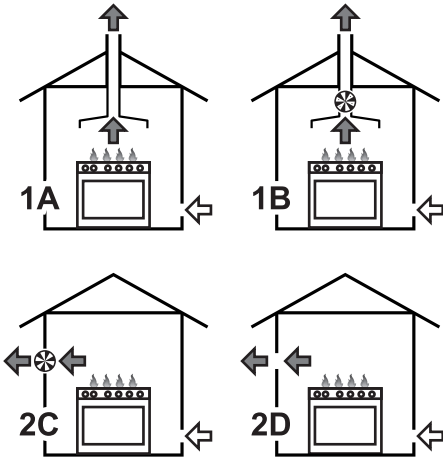

5.6 Adaptation to different types of gas

If other types of gas are to be used, the nozzles must be replaced and the primary air must be adjusted. In order to replace the nozzles and adjust the burners, the hob top must be removed.



Removing the hob top

1. Remove the grids from the hob.

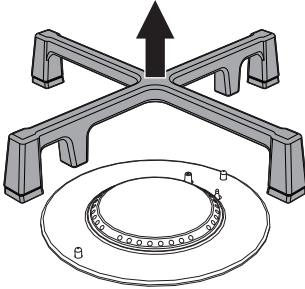

2. Remove the flame-spreader crowns and relative burner caps.

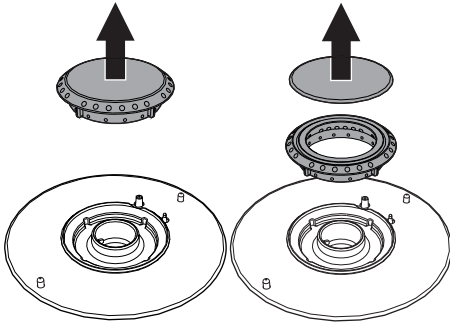

3. Pull the knobs upwards to remove them.

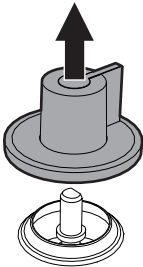

4. Unscrew the burner rings using the supplied wrench.

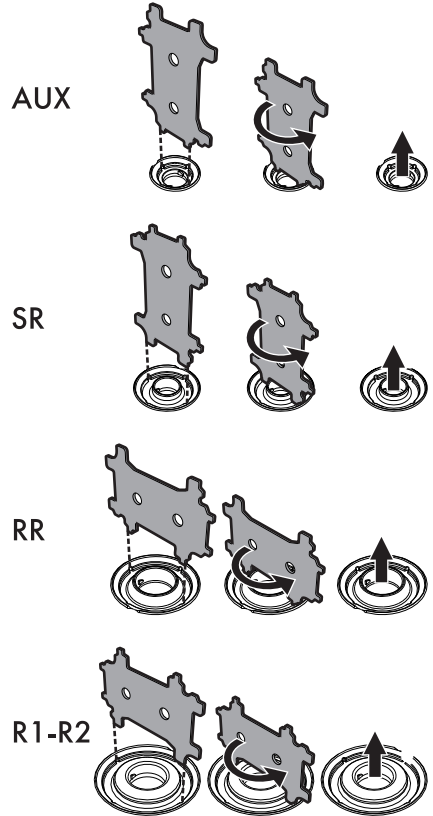

5. Remove the top.

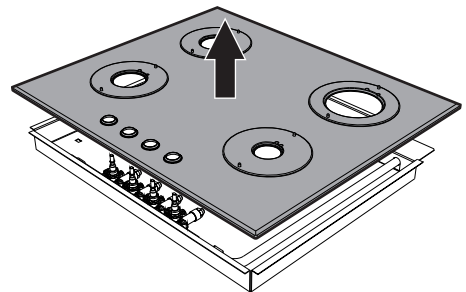



Installation

Replacing nozzles

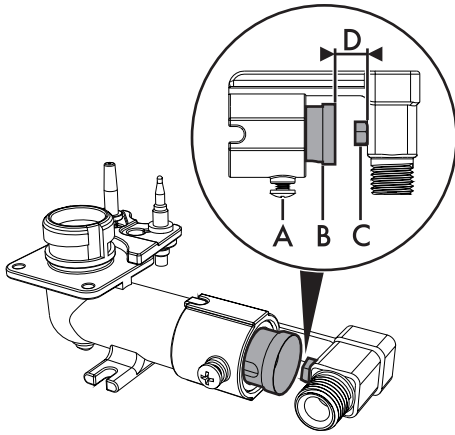

1. Unscrew screw **A** and push air regulator **B** as far as it will go.
2. Use a spanner to remove the nozzles **C** and install the new ones for the required gas supply, following the indications given in the relevant table (see "Gas types and Countries").



The nozzle tightening torque must be no more than 3 Nm.

3. Adjust the air flow by moving the air regulator **B** to obtain the distance **D** given in the relevant table (see "Gas types and Countries").
4. After adjusting each burner, reassemble the appliance correctly.

Adjusting the minimum setting for natural or city gas

Light the burner and turn it to the minimum position. Extract the gas tap knob and turn the adjustment screw next to the tap rod (depending on the model) until the correct minimum flame is achieved.

Refit the knob and verify that the burner flame is stable. Turn the knob rapidly from the maximum to the minimum setting: the flame should not go out. Repeat the operation on all gas taps.

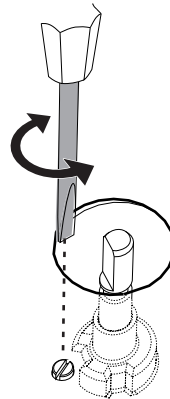



Adjusting the minimum setting for LPG

Tighten the screw located at the side of the tap rod clockwise all the way.



Following adjustment to a gas other than the one originally set in the factory, replace the gas setting label fixed to the appliance with the one corresponding to the new gas. The label is inserted inside the nozzle pack (where present).

Lubricating the gas taps

Over time the gas taps may become difficult to turn and get blocked. Clean them internally and replace the lubrication grease.



Lubrication of the gas taps should be performed by a specialised technician.



Installation

Gas types and Countries

N°	Gas types	IT	GB-IE	FR-BE	DE	AT	NL	ES	PT	SE	RU	DK
1 Natural Gas G20												
	G20 20 mbar	•	•		•	•		•	•	•	•	•
	G20/25 20/25 mbar			•								
2 Natural Gas G25												
	G25 25 mbar						•					
3 Natural Gas G25												
	G25 20 mbar				•							
4 LPG G30/31												
	G30/31 28/37 mbar		•	•				•			•	
	G30/31 30/37 mbar	•							•			
	G30/31 30/30 mbar						•			•		•
5 LPG G30/31												
	G30/31 50 mbar				•	•						
6 City Gas G110												
	G110 8 mbar	•								•		•
7 City Gas G120												
	G120 8 mbar									•		



It is possible to identify the available gas types based on the country the appliance is to be installed in. Refer to the heading number to identify the correct values in the "Burner and nozzle characteristics tables".



Burner and nozzle characteristics tables

1	Natural Gas G20	AUX	SR	RR	R1	R2
	Rated heating capacity (kW)	1.1	1.7	2.6	3.2	3.0
	Nozzle diameter (1/100 mm)	76	95	117	130	126
	Reduced capacity (W)	400	500	750	1050	1050
	Primary air (mm)	1.0	1.0	1.0	1.5	1.5
2	Natural Gas G25 25 mbar	AUX	SR	RR	R1	R2
	Rated heating capacity (kW)	1.1	1.7	2.6	3.1	3.0
	Nozzle diameter (1/100 mm)	76	95	117	130	126
	Reduced capacity (W)	400	500	750	1050	1050
	Primary air (mm)	1.0	1.0	1.0	1.5	1.5
3	Natural Gas G25 20 mbar	AUX	SR	RR	R1	R2
	Rated heating capacity (kW)	1.1	1.7	2.6	3.2	3.0
	Nozzle diameter (1/100 mm)	82	105	126	145	135
	Reduced capacity (W)	400	500	750	1050	1050
	Primary air (mm)	1.0	1.0	1.0	1.5	1.5
4	LPG G30/31	AUX	SR	RR	R1	R2
	Rated heating capacity (kW)	1.1	1.7	2.6	3.2	3.0
	Nozzle diameter (1/100 mm)	48	62	76	85	82
	Reduced capacity (W)	400	500	750	1050	1050
	Primary air (mm)	4	2	2	10	3
	Rated capacity G30 (g/h)	80	124	189	233	218
	Rated capacity G31 (g/h)	79	121	186	229	214
5	LPG G30/31 50 mbar	AUX	SR	RR	R1	R2
	Rated heating capacity (kW)	1.1	1.7	2.6	3.2	3.0
	Nozzle diameter (1/100 mm)	42	54	67	73	73
	Reduced capacity (W)	450	550	850	1050	1050
	Primary air (mm)	2	1	0.5	1.5	1.5
	Rated capacity G30 (g/h)	80	131	189	233	218
	Rated capacity G31 (g/h)	79	129	186	229	214
6	City Gas G110 8 mbar	AUX	SR	RR	R1	R2
	Rated heating capacity (kW)	1.1	1.7	2.6	3.2	2.9
	Nozzle diameter (1/100 mm)	132	165	230	270	250
	Reduced capacity (W)	400	500	750	1050	1050
	Primary air (mm)	1.0	0.5	1	1	1
7	City Gas G120 8 mbar	AUX	SR	RR	R1	R2
	Rated heating capacity (kW)	1.1	1.7	2.6	3.2	3.0
	Nozzle diameter (1/100 mm)	126	160	210	240	230
	Reduced capacity (W)	400	500	750	1050	1050
	Primary air (mm)	1	0.5	1	1	1

Nozzles which are not provided are available at Authorised Service Centres.



Installation

5.7 Electrical connection



**Power voltage
Danger of electrocution**

- Have the electrical connection performed by authorised technical personnel.
- Use personal protective equipment.
- The appliance must be connected to earth in compliance with electrical system safety standards.
- Disconnect the main power supply.
- Do not pull the cable to remove the plug.
- Use cables withstanding a temperature of at least 90°C.
- The tightening torque of the screws of the terminal supply wires must be 1.5 - 2 Nm.

The appliance can work in the following modes:

- 220-240 V 1N~

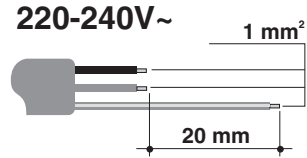

3 x 1 mm² three-core cable.



The values indicated above refer to the cross-section of the internal conductor.

Fixed connection

Fit the power line with an omnipolar circuit breaker in compliance with installation regulations.

The circuit breaker should be located near the appliance and in an easily reachable position.

Connection with plug and socket

Make sure that the plug and socket are of the same type.

Avoid using adapters and shunts as these could cause overheating and a risk of burns.

General information

Check the grid characteristics against the data indicated on the plate.

The identification plate bearing the technical data, serial number and brand name is visibly positioned on the appliance.

Do not remove this plate for any reason.

Perform the ground connection using a wire that is 20 mm longer than the other wires.