



KIDSCOT

DE Spülmitteldispenser
FR Distributeur de produit à vaisselle
IT Distributore sapone
EN Soap dispenser



- DE** Diese Anleitung muss dem Benutzer ausgehändigt werden.
Garantie/Haftung nur bei Montage gemäss Anleitung durch eine Konzessionierte Fachkraft und gemäss Örtlichen Vorschriften.
- FR** Cette instruction doit être remise à l'utilisateur.
Garantie/responsabilité uniquement assurées en cas de montage conforme au mode d'emploi effectué par un spécialiste concessionnaire et en fonction des prescriptions locales.
- IT** Le Presenti istruzioni devono essere consegnate all'utilizzatore.
Garanzia / responsabilità assicurate soltanto in caso di montaggio conforme alle istruzioni per l'uso e eseguito da uno specialista concessionario in funzione delle prescrizioni locali.
- EN** This instructions must be given to the user.
Guarantee/liability only when assembled by an approved specialist in accordance with the instructions and local regulations.

Technische Daten
Données techniques
Dati tecnici
Technical data

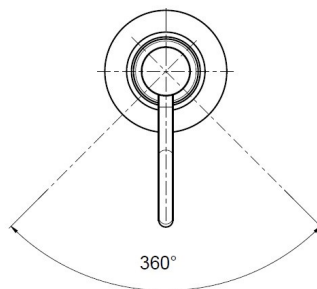
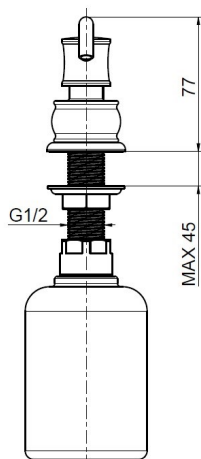
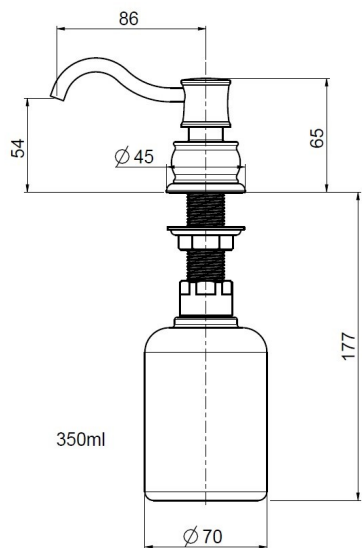

Montage
Installation
Installazione
Installation

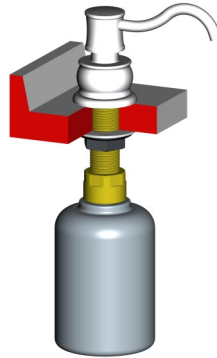
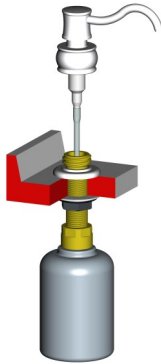
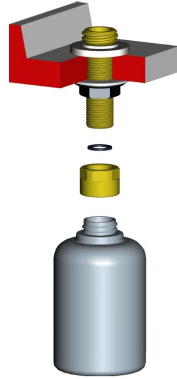
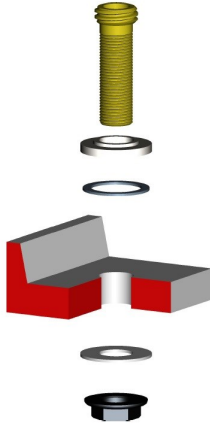

Pflegeanleitung
Mode d'entretien
Modalità di manutenzione
Maintenance Instruction

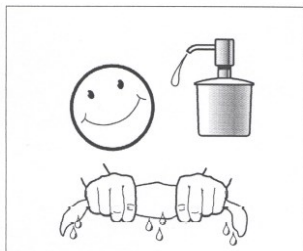
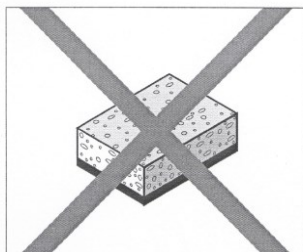
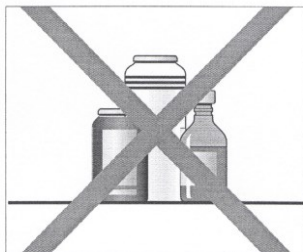

DE Pflegeanleitung

Die Oberfläche ist einfach zu reinigen und zu pflegen. Die glatte Oberfläche nimmt kaum Schmutz an. Zur regelmäßigen Pflege weiches Tuch, Seifenlauge und Wasser verwenden. Mit trockenem Tuch abtrocknen.

Vermeiden Sie den Einsatz von Scheuermitteln oder Lösungsmitteln, die die Oberfläche beschädigen.

Schäden, die durch unsachgemäße Behandlung durch den Benutzer entstehen, entziehen sich unserer Garantieleistung.

FR Mode d'entretien

Cette surface est facile à entretenir. Très lisse, elle retient fort peu la saleté. Pour un entretien régulier, utiliser un chiffon doux, du savon et de l'eau. Essuyer avec un chiffon sec.

Évitez d'utiliser des détergents ou des solvants qui endommageraient cette surface.

Les dommages résultant d'un traitement non conforme effectué par l'utilisateur sont exclus de la garantie que nous offrons.

IT Modalità di manutenzione

Questa superficie è facile da pulire. Molto liscia, trattiene poco lo sporco. Per una pulizia regolare, usare un panno morbido, sapone e acqua. Asciugare con uno straccio asciutto.

Evitare di usare detersivi o solventi che potrebbero danneggiare la superficie.

I danni dovuti a un trattamento non conforme effettuato dall'utente non sono coperti dalla nostra garanzia.

EN Maintenance instructions

The surface is simple to clean and care for. The smooth surface hardly accumulates any dirt. Use soft cloth, soapy solution and water for regular care. Wipe with a dry cloth.

Avoid the use of abrasives or solvents, which damage the surface.

Damage caused by inappropriate treatment by the user, is not covered by our guarantee.

 smeg

Via Leonardo da Vinci, 4
42016 Guastalla (RE)
Italy

E-mail: servizio.clienti@smeg.it

Web site: www.smeg.it