

Contents

1	Instructions	79
1.1	General safety instructions	79
1.2	Appliance purpose	83
1.3	Manufacturer liability	83
1.4	This user manual	84
1.5	Identification plate	84
1.6	Disposal	84
1.7	How to read the user manual	85
2	Description	86
2.1	General Description	86
2.2	Cooking hob	87
2.3	Control panel	87
2.4	Other parts	88
2.5	Available accessories	89
3	Use	91
3.1	Instructions	91
3.2	First use	92
3.3	Using the accessories	93
3.4	Using the hob	96
3.5	Using the oven	97
3.6	Cooking advice	105
3.7	Special functions	107
3.8	Automatic programs	110
3.9	Secondary menu	113
3.10	Using the storage compartment	116
4	Cleaning and maintenance	117
4.1	Instructions	117
4.2	Cleaning the appliance	117
4.3	Removing the door	118
4.4	Cleaning the door glazing	119
4.5	Vapor Clean (on some models only)	122
4.6	Pyrolytic (on some models only)	125
4.7	Extraordinary maintenance	127
5	Installation	130
5.1	Gas connection	130
5.2	Adaptation to different types of gas	135
5.3	Positioning	140
5.4	Electrical connection	147
5.5	Instructions for the installer	149

We advise you to read this manual carefully, which contains all the instructions for maintaining the appliance's aesthetic and functional qualities.

For further information on the product: www.smeg.com



1 Instructions

1.1 General safety instructions

Risk of personal injury

- During use the appliance and its accessible parts become very hot. Never touch the heating elements during use.
- Protect your hands by wearing oven gloves when moving food inside the oven
- Never try to put out a fire or flames with water: Turn off the appliance and smother the flames with a fire blanket or other appropriate cover.
- This appliance may be used by children aged at least 8 and by people of reduced physical, sensory or mental capacity, or lacking in experience in the use of electrical appliances, provided that they are supervised or instructed by adults who are responsible for their safety.
- Children must not play with the appliance.
- Keep children under the age of eight at a safe distance unless they are constantly supervised.
- Keep children under the age of 8 away from the appliance when it is in use.
- Cleaning and maintenance must not be carried out by unsupervised children.
- Make sure that the flame-spreader crowns are correctly positioned in their housings with their respective burner caps.
- Be aware of how rapidly the cooking zones heat up. Do not place empty pans on the heat. Danger of overheating.
- Fats and oils can catch fire if they overheat. Do not leave the appliance unattended while preparing foods containing oils or fats. If fats or oils catch fire, never put water on them. Place the lid on the pan and turn off the relevant cooking zone.



Description

- The cooking process must always be monitored. A short cooking process must be continuously monitored.
- Do not place metal objects, such as dishes or cutlery, on the hob surface during use as they may overheat.
- Do not insert pointed metal objects (cutlery or utensils) into the slots in the appliance.
- Do not pour water directly onto very hot trays.
- Keep the oven door closed during cooking.
- If you need to move food or at the end of cooking, open the door 5 cm for a few seconds, let the steam come out, then open it fully.
- Do not open the storage compartment (where present) when the oven is on and still hot.
- The items inside the storage compartment could be very hot after using the oven.
- Do not use or store flammable materials in the storage compartment (where applicable) or near the appliance.
- Do not use aerosols in the vicinity of this appliance whilst it is in use.
- Switch off the appliance immediately after use.
- Do not modify this appliance.
- Always use any necessary/required personal protective equipment (PPE) before performing any work on the appliance (installation, maintenance, positioning or movement).
- Before performing any work on the appliance, switch off the power supply.
- Have qualified personnel carry out installation and assistance interventions according to the standards in force.
- Do not try to repair the appliance yourself or without the intervention of a qualified technician.
- Do not pull the cable to remove the plug.
- If the power supply cable is damaged, contact technical support immediately and they will replace it.



Risk of damaging the appliance

- Do not use abrasive or corrosive detergents (e.g. scouring powders, stain removers and metallic sponges) on glass parts.
- Use wooden or plastic utensils.
- Racks and trays should be inserted as far as they will go into the side guides. The mechanical safety locks that prevent them from being removed must face downwards and towards the back of the oven
- Do not seat on the appliance.
- Do not use steam jets to clean the appliance.
- Do not obstruct ventilation openings and heat dispersal slots.
- Never leave the appliance unattended during cooking operations where fats or oils could be released, as these could then heat up and catch fire. Be very careful.
- Never leave objects on the cooking surface.
- Do not use the appliance to heat rooms for any reason.
- Do not spray any spray products near the oven.
- Do not use plastic cookware or containers when cooking food.
- Do not put sealed tins or containers in the oven.
- Remove all trays and racks which are not required during cooking.
- Do not cover the bottom of the oven cavity with aluminium or tin foil sheets.
- Do not place pans or trays directly on the bottom of the oven cavity.
- If you wish to use greaseproof paper, place it so that it will not interfere with the hot air circulation inside the oven.
- Do not use the open door to rest pans or trays on the internal glass pane.
- Cooking vessels or griddle plates should be placed inside the perimeter of the hob.
- All pans must have smooth, flat bottoms.



Instructions

- If any liquid does boil over or spill, remove the excess from the hob.
- Take care not to spill acid substances such as lemon juice or vinegar on the hob.
- Do not put empty pans or frying pans on switched on cooking zones.
- Do not use steam jets to clean the appliance.
- Do not use rough or abrasive materials or sharp metal scrapers.
- Do not use cleaning products containing chlorine, ammonia or bleach on parts made of steel or that have metallic surface finishes (e.g. anodizing, nickel- or chromium-plating).
- Do not use abrasive or corrosive detergents (e.g. scouring powders, stain removers and metallic sponges) on glass parts.
- Do not wash removable parts such as the hob grids, flame-spreader crowns and burner caps in a dishwasher.
- This appliance can be used up to a maximum altitude of 2,000 metres above sea level.
- Never use the oven door to lever the appliance into place when fitting.
- Avoid exerting too much pressure on the oven door when open.
- Do not use the handle to lift or move the appliance.
- Do not spray cleaning products directly onto the door, as they may get into areas that are difficult to access and rinse off. Over time, they may react with painted panels or steel.

Installation

- This appliance **must not be installed** in a boat or caravan.
- The appliance must not be installed on a pedestal.
- Position the appliance into the cabinet cutout with the help of a second person.
- To avoid potential overheating, the appliance must not be installed behind a decorative door or a panel.
- Have the gas connection performed by authorised technical personnel.
- Installation using a hose must be carried out so that the length of the hose does not exceed 2 metres when fully extended for steel hoses and 1.5 metres for rubber hoses.



- The hoses should not come into contact with moving parts and should not be crushed in any way.
- If required, use a pressure regulator that complies with current regulations.
- After carrying out any operation, check that the tightening torque of gas connections is between 10 Nm and 15 Nm.
- At the end of the installation, check for any leaks with a soapy solution, never with a flame.
- Have the electrical connection performed by authorised technical personnel.
- The appliance must be connected to earth in compliance with electrical system safety standards.
- Use cables withstanding a temperature of at least 90°C.
- The tightening torque of the screws of the terminal supply wires must be 1.5 - 2 Nm.

For this appliance

- Ensure that the appliance is switched off before replacing the bulb.
- Do not rest any weight or sit on the open door of the appliance.
- Take care that no objects are stuck in the doors.

1.2 Appliance purpose

- This appliance is intended for cooking food in the home environment. Every other use is considered improper.
- The appliance is not designed to operate with external timers or with remote-control systems.

1.3 Manufacturer liability

The manufacturer declines all liability for damage to persons or property caused by:

- Use of the appliance other than that specified;
- Failure to comply with the instructions in the user manual;
- Tampering with any part of the appliance;
- The use of non-original spare parts.



Instructions

1.4 This user manual

This user manual is an integral part of the appliance and must therefore be kept in its entirety and within the user's reach for the whole working life of the appliance.

Read this user manual carefully before using the appliance.

1.5 Identification plate

The identification plate bears the technical data, serial number and brand name of the appliance. Do not remove the identification plate for any reason.

1.6 Disposal



This appliance must be disposed of separately from other waste (Directives 2002/95/EC, 2002/96/EC, 2003/108/EC). The appliance does not contain substances in quantities sufficient to be considered hazardous to health and the environment, in accordance with current European directives.

To dispose of the appliance:

- Cut the power supply cable and remove it along with the plug.



Power voltage

Danger of electrocution

- Disconnect the mains power supply.
- Unplug the appliance.

- Deliver the appliance to the appropriate recycling centre for electrical and electronic equipment waste, or return it to the retailer when purchasing an equivalent product, on a one for one basis.

Our appliances are packaged in non-polluting and recyclable materials.

- Deliver the packing materials to the appropriate recycling centre.



Plastic packaging

Danger of suffocation

- Do not leave the packaging or any part of it unattended.
- Do not let children play with the plastic bags.



1.7 How to read the user manual

This user manual uses the following reading conventions:

Instructions



General information on this user manual, on safety and final disposal.

Description



Description of the appliance and its accessories.

Use



Information on the use of the appliance and its accessories, cooking advice.

Cleaning and maintenance



Information for proper cleaning and maintenance of the appliance.

Installation



Information for the qualified technician: Installation, operation and inspection.



Safety instructions



Information



Advice

1. Sequence of instructions for use.

- Standalone instruction.



Description

2 Description

2.1 General Description

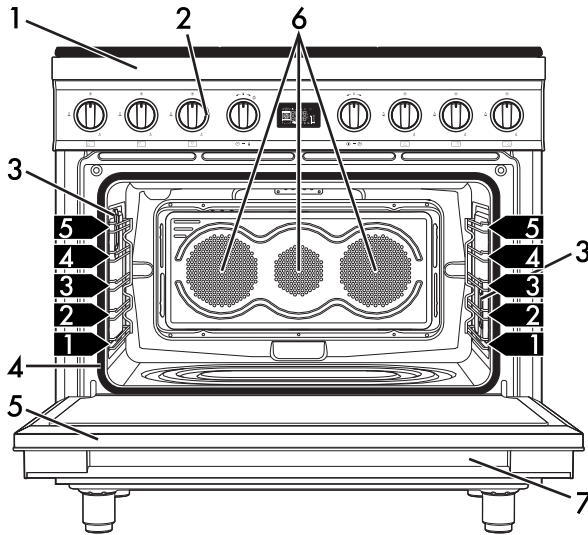

- 1 Cooking hob
- 2 Control panel
- 3 Oven light
- 4 Seal

- 5 Door
- 6 Fan
- 7 Storage compartment

1,2,3... Rack/tray support frames



2.2 Cooking hob

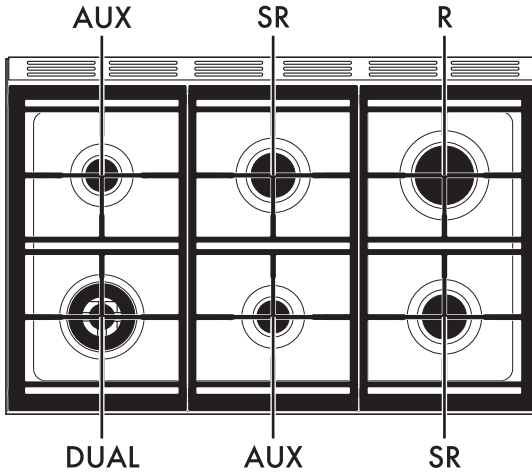

AUX = Auxiliary
SR = Semi-rapid

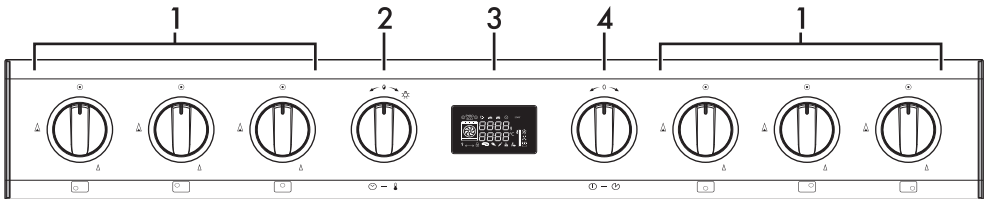

R = Rapid
DUAL = Ultra-rapid

2.3 Control panel



1 Hob burner knobs

Used for lighting and adjusting the hob burners.

Press and turn the knobs anti-clockwise to  in order to light the relative burners. Turn the knobs to the zone between the maximum  and minimum  setting to adjust the flame.

Return the knobs to the position  to turn off the burners.

2 Temperature knob

This knob allows you to select the cooking time and temperature, set programmed cooking and the current time as well as turn the light inside the oven on and off.

EN



Description

3 Display

Displays the current time, the selected cooking temperature and function and any time set.

4 Function knob

This knob allows you to turn the appliance on and off and select the cooking function.

2.4 Other parts

Cooling fan

The fan cools the oven and comes into operation during cooking.

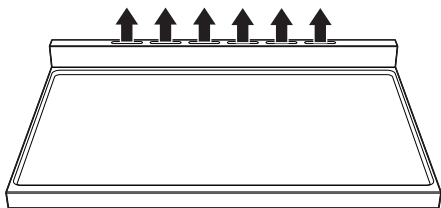

The fan causes a steady outflow of air that exits from the rear of the appliance and which may continue for a brief period of time even after the appliance has been turned off.



Do not obstruct ventilation openings and heat dispersal slots.

Interior lighting

The appliance's interior lighting comes on:

- When the door is opened.
- When any function is selected, apart from the **ECO** +  and  functions (multifunction models), and the **PYRO** and **PYRO ECO** functions (pyrolytic models).
- When the temperature knob is briefly turned to the right (manual activation and deactivation).



When the door is open, it is not possible to turn off the interior lighting.

Shelves

The appliance features shelves to position trays and racks at different heights. The insertion heights are indicated from the bottom upwards (see 2.1 General Description).

2.5 Available accessories

WOK ring

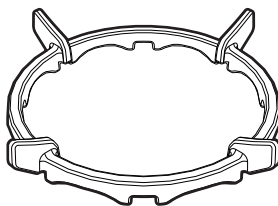

Useful when using a wok.



Tray rack

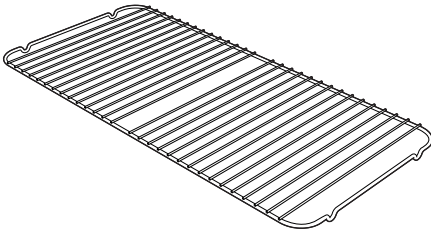

To be placed over the top of the oven tray; for cooking foods which may drip.

Oven tray

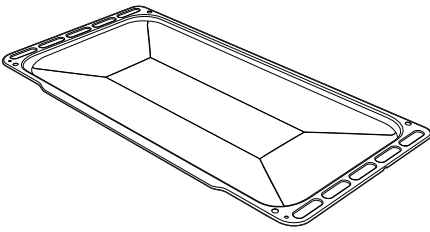

Useful for collecting fat from foods placed on the rack above.

Deep tray

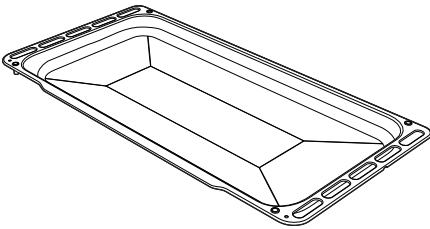

Useful for collecting fat from foods placed on the rack above and for cooking pies, pizzas and baked desserts.

Rack

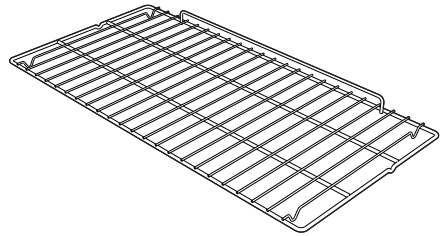

Useful for supporting containers with food during cooking.

i Some models are not provided with all accessories.

i The accessories intended to come into contact with food are made of materials that comply with the provisions of current legislation.

i Supplied and optional accessories can be requested to Authorised Assistance Centres. Use only original accessories supplied by the manufacturer.



Use

3 Use

3.1 Instructions



High temperature inside the oven during use

Danger of burns

- Keep the oven door closed during cooking.
- Protect your hands by wearing oven gloves when moving food inside the oven.
- Do not touch the heating elements inside the oven.
- Do not pour water directly onto very hot trays.
- Keep children under the age of 8 away from the appliance when it is in use.
- If you need to move food or at the end of cooking, open the door 5 cm for a few seconds, let the steam come out, then open it fully.



Improper use

Danger of burns

- Make sure that the flame-spreader crowns are correctly positioned in their seats with their respective burner caps.
- Oils and fats could catch fire if overheated. Be very careful.



Improper use

Risk of damage to surfaces

- Do not cover the bottom of the oven cavity with aluminium or tin foil sheets.
- If you wish to use greaseproof paper, place it so that it will not interfere with the hot air circulation inside the oven.
- Do not place pans or trays directly on the bottom of the oven cavity.
- Do not use the open door to rest pans or trays on the internal glass pane.
- Do not pour water directly onto very hot trays.
- Cooking vessels or griddle plates should be placed inside the perimeter of the hob.
- All pans must have smooth, flat bottoms.
- If any liquid does boil over or spill, remove the excess from the hob.



High temperature inside the storage compartment

Danger of burns

- Do not open the storage compartment when the appliance is on and still hot.
- The items inside the storage compartment could be very hot after using the appliance.



High temperature inside the oven during use
Danger of fire or explosion

- Do not spray any spray products near the appliance.
- Do not use or leave flammable materials near the appliance or the storage compartment.
- Do not use plastic cookware or containers when cooking food.
- Do not put sealed tins or containers in the oven.
- Do not leave the appliance unattended during cooking operations where fats or oils could be released.
- Remove all trays and racks which are not required during cooking.

A gas leak can cause an explosion.

If you smell gas or there are faults in the gas system:

- Immediately turn off the gas supply or close the valve on the gas cylinder.
- Extinguish all naked flames and cigarettes.
- Do not turn on power switches or appliances and do not remove plugs from power sockets. Do not use phones or mobile phones inside the building.
- Open the window in order to ventilate the room.
- Call customer assistance services or your gas supplier.

Malfunctions

Any of the following indicate a malfunction and you should contact a service centre.

- Yellowing of the burner plate.
- Damage to kitchen utensils.
- The burners do not ignite properly.
- It is difficult to keep the burners lit.
- The burners go out when the appliance is in use.
- It is difficult to turn the gas valves.

If the appliance does not work properly, contact your local Authorised Service Centre.

3.2 First use

1. Remove any protective film from the outside or inside of the appliance, including accessories.
2. Remove any labels (apart from the technical data plate) from the accessories and from the oven cavity.
3. Remove and wash all the appliance accessories (see 4 Cleaning and maintenance).
4. Heat the empty appliance to the maximum temperature to burn off any residues left by the manufacturing process.



3.3 Using the accessories

Ring reducers

The ring reducers must be placed on the hob grids. Make sure they are placed properly.

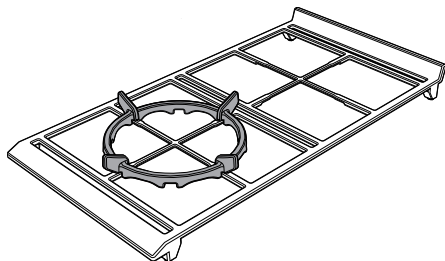

Tray rack

The tray rack has to be inserted into the tray. In this way fat can be collected separately from the food which is being cooked.

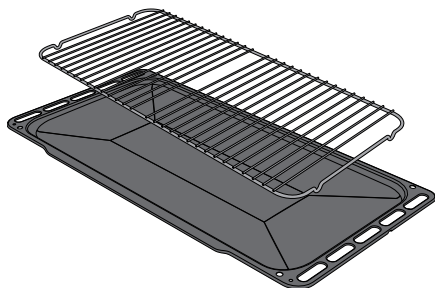

Racks and trays

Racks and trays have to be inserted into the side guides until they come to a complete stop.

The mechanical safety locks that prevent the rack from being taken out accidentally have to face downwards and towards the oven back.

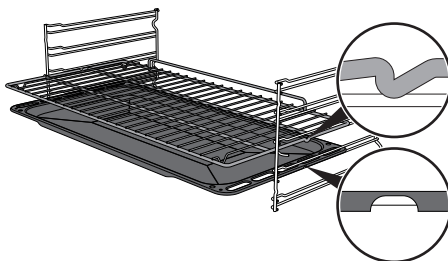

Gently insert racks and trays into the oven until they come to a stop.



Clean the trays before using them for the first time to remove any residues left by the manufacturing process.



3.4 Using the hob

All the appliance's control and monitoring devices are located together on the front panel. The burner controlled by each knob is shown next to the knob. The appliance is equipped with an electronic ignition device. Simply press the knob and turn it anti-clockwise to the maximum flame symbol, until the burner ignites. If the burner does not light in the first 15 seconds, turn the knob to  and wait 60 seconds before trying again. After lighting, keep the knob pressed in for a few seconds to allow the thermocouple to heat up.

The burner may go out when the knob is released: In this case, the thermocouple has not heated up sufficiently. Wait a few moments and repeat the operation. Keep the knob pressed in longer.



In case of an accidental switching off, a safety device will be tripped, cutting off the gas supply, even if the gas cock is open. Return the knob to  and wait at least 60 seconds before lighting it again.

Correct positioning of the flame-spreader crowns and burner caps

Before lighting the hob burners, make sure that the flame-spreader crowns are correctly positioned in their seats with their respective burner caps. Make sure that the holes **1** of the flame-spreader crowns are aligned with the thermocouples **2** and igniters **3**.

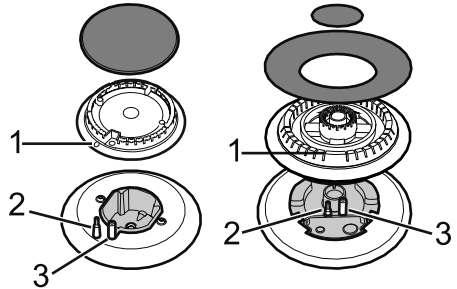

Practical tips for using the hob

For better burner efficiency and to minimise gas consumption, use pans with lids and of suitable size for the burner, so that the flames do not reach up the sides of the pan. Once the contents come to the boil, turn down the flame far enough to ensure that the liquid does not boil over.



Cookware diameters:

- AUX: 12 - 14 cm.
- SR: 16 - 24 cm.
- R: 18 - 26 cm.
- DUAL: 18 - 28 cm.



Correct positioning of the hob grids

Before lighting the hob burners, make sure that the grids are correctly positioned on the hob.

Bear in mind that:

- Each grid has its own position on the hob.
- The raised section must always face the appliance's upstand.

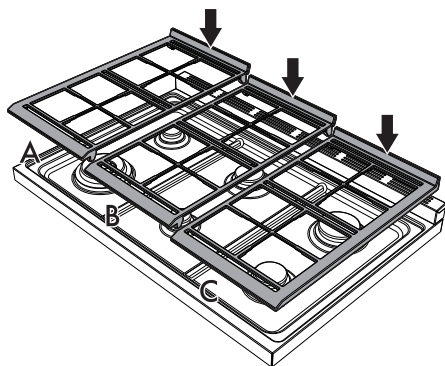

- The left-hand (**A**) and right-hand (**C**) grids have one thicker edge which must be turned to face the side of the appliance.
- The edges of the centre grid (**B**) are of the same thickness.

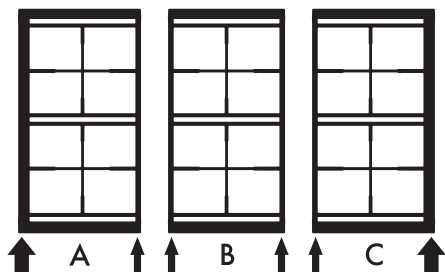

3.5 Using the oven

Display

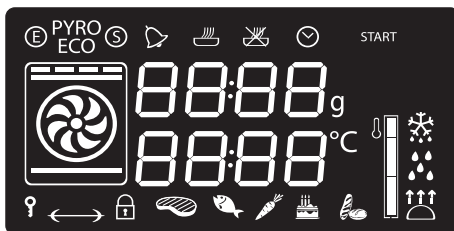

- Eco logic indicator light
- Pyrolytic function indicator light (pyrolytic models only)
- Showroom indicator light
- Minute minder timer indicator light
- Timed cooking indicator light
- Programmed cooking indicator light
- Clock indicator light
- Child lock indicator light
- Door lock indicator light (pyrolytic models only)
- Temperature level reached



Operating modes





Stand-by: When no function is selected, the display shows the current time.

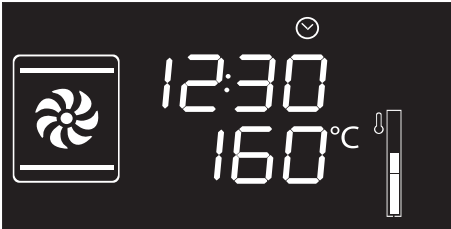

ON: When a function is activated, the display shows the parameters set such as temperature, duration and temperature reached.



Each time the temperature knob is pressed during a function, the parameters will be cycled through in the following order.

-  Temperature
-  Minute minder timer duration
-  Function duration
-  Programmed cooking duration (if timed cooking has been selected)
-  Time display

In all modes it is possible to modify the value by turning the temperature knob to the left or right. Keep the knob turned to produce a faster increase or decrease.

Setting the time

When using the appliance for the first time, or after a power failure, the symbol

 will flash on the display. To be able to start any cooking function, the current time must be set.

1. Turn the temperature knob to set the displayed time (keep the knob turned to produce a faster increase or decrease).
2. Press the temperature knob.
3. Turn the temperature knob to set the minutes (keep the knob turned to produce a faster increase or decrease).



Use

4. Press the temperature knob to finish adjustment.



It may become necessary to change the current time, for example for daylight saving time. From the stand-by position, keep the temperature knob turned to the right or left until the hours flash.

It is not possible to change the time if the oven is **ON**.

The temperature level reached indication flashes to indicate that this stage is in progress.



When the preheating stage is complete, temperature level reached indication will remain lit steadily and a buzzer sounds to indicate that the food can be placed inside the oven.



Cooking functions

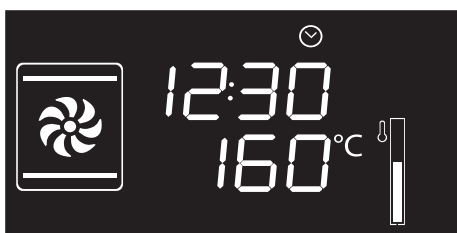

1. Press and turn the function knob to select the required cooking function.
2. Press and turn the temperature knob to modify the cooking temperature.
3. Press the function knob to start traditional cooking.



A function can be interrupted at any time by pressing and holding the function knob for at least 3 seconds.

Functions list

ECO Eco



This function is particularly suitable for cooking on a single shelf with low energy consumption.

Ideal for cooking meat, fish and vegetables. It is not recommended for leavened foods.

To obtain maximum energy savings and reduce cooking times, it is recommended to place food in the oven without preheating.



When using the ECO function, avoid opening the door during cooking.



Cooking (and preheating) times are longer with the ECO function.

Preheating stage

Cooking itself is preceded by a preheating stage, which allows the appliance to heat to the cooking temperature more quickly.



Static

As the heat comes from above and below at the same time, this system is particularly suitable for certain types of food. Traditional cooking, also known as static cooking, is suitable for cooking just one dish at a time. Perfect for all types of roasts, bread and cakes, and in any case, particularly suitable for fatty meats such as goose and duck.



Grill

The heat coming from the grill element gives perfect grilling results above all for thin and medium thickness meat and, in combination with the rotisserie (where fitted), gives the food an even browning at the end of cooking. Perfect for sausages, spare ribs and bacon. This function enables large quantities of food, particularly meat, to be grilled evenly.



Lower element

The heat coming just from the bottom allows you to complete the cooking of foods that require a higher bottom temperature, without affecting their browning. Perfect for cakes, pies, tarts and pizzas.



Fan assisted

The operation of the fan, combined with traditional cooking, ensures consistent cooking even with complex recipes. Perfect for biscuits and cakes, even when simultaneously cooked on several levels. (For multiple-level cooking, we recommend using the 2nd and 4th shelf).



Fan with grill

The air produced by the fan softens the strong heatwave generated by the grill, grilling perfectly even very thick foods. Perfect for large cuts of meat (e.g. shin of pork).



Fan + lower element

The combination of the fan with just the lower heating element allows cooking to be completed more rapidly. This system is recommended for sterilising or for finishing off the cooking of foods which are already well-cooked on the surface, but not inside, which therefore need a little more heat. Perfect for any type of food.



Use



Circulaire

The combination of the fan and the circulaire heating element (incorporated in the rear of the oven) allows you to cook different foods on several levels, as long as they need the same temperature and type of cooking. Hot air circulation ensures instant and even distribution of heat. It will be possible, for instance, to cook fish, vegetables and biscuits simultaneously (on different levels) without odours and flavours mingling.



Turbo

The combination of fan assisted cooking and traditional cooking allows different foods to be cooked on several levels extremely quickly and efficiently, without odours and flavours mingling. Perfect for large volumes that call for intense cooking.



Timer





This function only activates the buzzer, without stopping cooking.

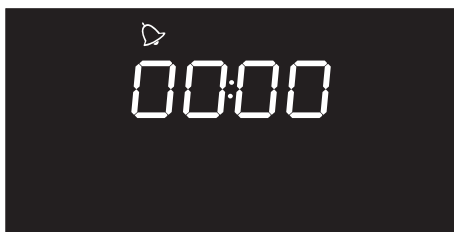

The minute minder can be activated both during cooking and when the appliance is in standby.

1. Press the temperature knob once (twice if cooking is already in progress). The display shows  and the indicator light  flashes.



2. Turn the temperature knob to set the duration (from 1 minute to 4 hours). After a few seconds, the indicator light  stops flashing and the countdown starts.
3. Select the required cooking function and wait for the buzzer to sound, indicating that the cooking time is over. The indicator light  flashes.



4. To deactivate the buzzer, press or turn one of the two knobs.
5. To select a further minute minder, turn the temperature knob.



You must set the value to zero to remove the minute minder.

Timed cooking



Timed cooking is the function which allows a cooking operation to be started and then ended after a specific length of time set by the user.



Activation of timed cooking cancels any minute minder timer which may previously have been set.

1. After selecting a cooking function and temperature, press the temperature knob three times. The display shows **00:00** and the indicator light flashes.

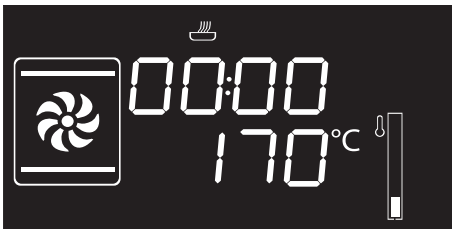

2. Turn the temperature knob right or left to set the cooking duration from 00:01 to 12:59. Keep the knob turned to produce a faster increase or decrease.

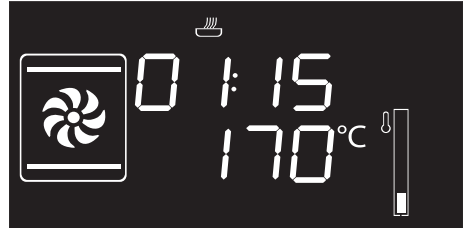

3. A few seconds after the required duration is set, the indicator light stops flashing and timed cooking starts.



To extend the cooking time manually, press the temperature knob again. The appliance will resume its normal operation with the previously selected cooking settings.

4. At the end of cooking, **StoP** is shown on the display and a buzzer sounds.





Use

- To deactivate the buzzer, press or turn one of the two knobs or open the door.



To deactivate the buzzer and select a further timed cooking, turn the temperature knob to the right.





To deactivate the buzzer and select a different cooking function, turn the function knob to the right or left.



Press and hold the function knob down to switch off the appliance.

Modifying the data set during timed cooking

During operation, it is possible to modify timed cooking duration:

- When the indicator light  is steady and cooking is in progress inside the appliance, press the temperature knob twice. The indicator light  starts flashing.
- Turn the temperature knob right or left to alter the pre-set cooking time.

Programmed cooking



Programmed cooking is the function which allows cooking to be stopped at an established time depending on the time set by the user, after which the appliance will switch off automatically.

- After selecting a cooking function and temperature, press the temperature knob three times. The display shows



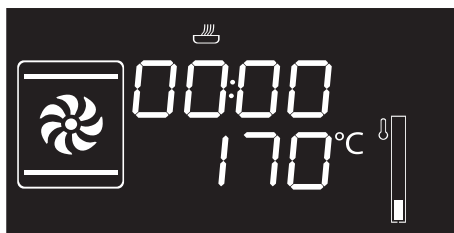

and the indicator light  flashes.

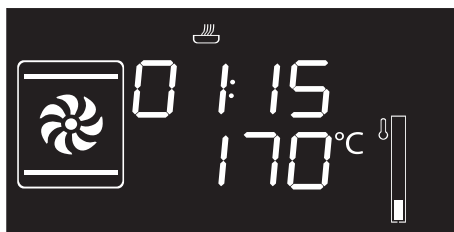

- Turn the knob right or left to set the cooking duration from 00:01 to 12:59. Keep the knob turned for a fast increase or decrease.





3. Press the temperature knob a fourth time. The indicator light  flashes. Turn the knob right or left to set the cooking end time.
4. After a few seconds the indicator lights  and  stop flashing. The appliance waits for the set start time.

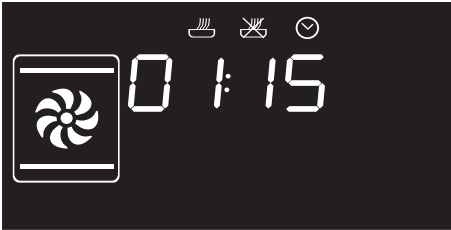

To extend the cooking time manually, press the temperature knob again. The appliance will resume its normal operation with the previously selected cooking settings.



With timed cooking, the oven is switched on ten minutes beforehand to allow the appliance to reach cooking temperature (preheating).

5. At the end of cooking, **STOP** is shown on the display and a buzzer sounds.

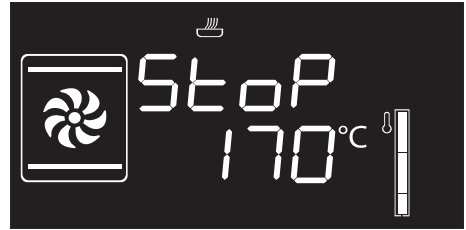

6. To deactivate the buzzer, press or turn one of the two knobs or open the door.



Press and hold the function knob down to switch off the appliance.



For safety reasons, it is not possible to set the end of cooking time by itself without setting the cooking duration.









Modifying the data set during programmed cooking



After modifying the cooking duration, the end of cooking time must be re-set.

During operation, it is possible to modify programmed cooking duration:

1. When the indicator lights  and  are lit steadily and the appliance is waiting for cooking to start, press the temperature knob twice. The indicator light  starts flashing.
2. Turn the temperature knob right or left to alter the pre-set cooking time.
3. Press the temperature knob again. The indicator light  switches off and the indicator light  starts flashing. The display shows the cooking end time.
4. Turn the temperature knob right or left to delay the cooking end time.
5. After a few seconds the indicator lights  and  stop flashing and programmed cooking resumes its operation with the new settings.

3.6 Cooking advice

General advice

- Use a fan assisted function to achieve consistent cooking at several levels.
- It is not possible to shorten cooking times by increasing the temperature (the food could be overcooked on the outside and undercooked on the inside).
- The weight being equal, the cooking time for cut pieces is lower than the cooking time for whole pieces.

Advice for cooking meat

- Cooking times vary according to the thickness and quality of the food and to consumer taste.
- Use a meat thermometer when roasting meat, or simply press on the roast with a spoon. If it is hard, it is ready; If not, it needs another few minutes cooking.

Advice for cooking with the Grill

- Meat can be grilled even when it is put into the cold oven or into the preheated oven if you wish to change the effect of the cooking.
- With the Fan with grill function, we recommend that you preheat the oven before grilling.
- We recommend placing the food at the centre of the rack.



Advice for cooking desserts/pastries and biscuits

- Use dark metal moulds: They help to absorb the heat better.
- The temperature and the cooking time depend on the quality and consistency of the dough.
- In the case of multiple-level cooking, position the food preferably on the 2nd and 4th shelves, increase the cooking time by a few minutes and use only fan-assisted functions.
- To check whether the dessert is cooked right through: At the end of the cooking time, put a toothpick into the highest point of the dessert. If the dough does not stick to the toothpick, the dessert is cooked.
- If the dessert collapses when it comes out of the oven, on the next occasion reduce the set temperature by about 10°C, selecting a longer cooking time if necessary.
- The cooking times for meringues and profiteroles vary according to size.

Advice for defrosting and proving

- Place frozen foods without their packaging in a lidless container on the first shelf of the oven.
- Avoid overlapping the food.

- To defrost meat, use the rack placed on the second level and a tray on the first level. In this way, the liquid from the defrosting food drains away from the food.
- Fruit and bread, if divided into pieces, take the same time to thaw, irrespective of the quantity and the total weight.
- The most delicate parts can be covered with aluminium foil.
- For successful proving, a container of water should be placed in the bottom of the oven.

To save energy

- Stop cooking a few minutes before the time normally used. Cooking will continue for the remaining minutes with the heat which has accumulated inside the oven.
- Reduce any opening of the door to a minimum to avoid heat dispersal.
- Keep the inside of the appliance clean at all times.
- (Where fitted) When it is not being used, remove the pizza plate from the bottom of the oven.



3.7 Special functions

Defrost by time



1. Place the food inside the oven.
2. Press and turn the function knob to select the defrost by time function .
3. Turn the temperature knob to set the duration (from 1 to 99 minutes).
4. Press the temperature knob to confirm the set duration. **START** flashes.
5. Press the function knob to start the defrost by time function.
6. At the end, **StoP** is displayed and a buzzer sounds.
7. To deactivate the buzzer, press or turn one of the two knobs or open the door.
8. Press and hold the function knob for at least 3 seconds to exit the function.

Proving

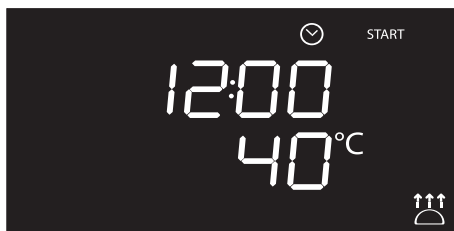

When using the proving function the temperature cannot be altered.



For successful proving, a container of water should be placed in the bottom of the oven.

1. Position the dough for proving on the second shelf.
2. Press and turn the function knob to select the proving function .
3. Press the function knob to start the proving function. **START** flashes.
3. Press the function knob to start the proving function.
4. At the end, **StoP** is displayed and a buzzer sounds.
5. To deactivate the buzzer, press or turn one of the two knobs or open the door.
6. Press and hold the function knob for at least 3 seconds to exit the function.



Sabbath



This function allows food to be cooked in accordance with the provisions of the Jewish religion day of rest.



This function results in the appliance operating in a particular way:

- Cooking can proceed indefinitely, it is not possible to set any time.
- No preheating will be performed.
- The cooking temperature which can be selected varies between 60-100 °C.
- Oven light disabled, any operation such as opening the door or manual activation with the knob will not activate the light.
- The internal fan remains turned off.
- Knob illumination and audible prompts remain disabled.



After activating the Sabbath function the settings cannot be altered.

Any action on the knobs will produce no effect; only the function knob remains active to allow the appliance to be turned off.

1. Press and turn the function knob to select the Sabbath function **SAbb**.
2. Press and turn the temperature knob to modify the temperature of the function.
3. Press the temperature knob to confirm the set temperature. **START** flashes.
4. Press the function knob to start the Sabbath function.
5. Press and hold the function knob for at least 3 seconds to exit the function.



Use

Defrost by weight

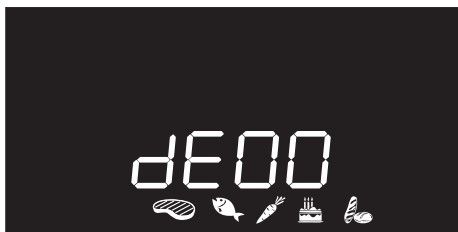





i This function defrosts foods on the basis of the type and weight of the frozen products.

1. Place the food inside the oven.
2. Press and turn the function knob to select defrost by weight, marked by **dE00** and the illuminated food symbols .
3. Press the function knob to confirm the defrost by weight function.
4. Turn the function knob to select the type of food to defrost.

5. Turn the temperature knob to select the weight (in grams) of the food to defrost.
6. Press the function knob to confirm the parameters and start defrosting.
7. At the end, **Stop** is displayed and a buzzer sounds.
8. To deactivate the buzzer, press or turn one of the two knobs or open the door.
9. Press and hold the function knob for at least 3 seconds to exit the function.

Pre-set parameters

dE	Type	Weight (g)	Time (min)*
01 	Meat	500	120
02 	Fish	300	55
03 	Fruit	300	35
04 	Bread	300	25

* Defrosting times may vary on the basis of the shape and size of the food to be defrosted.



3.8 Automatic programs

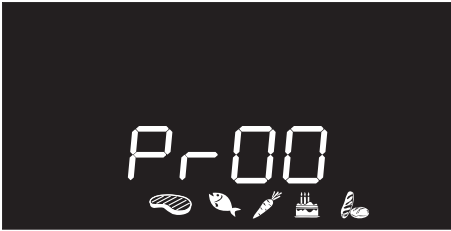

The automatic cooking programs are divided up according to the type of dish to be cooked.

1. Press and turn the function knob to select cooking with automatic programs, marked by **Pr-00** and the illuminated food symbols



2. Press the function knob to confirm cooking with automatic programs.
3. Turn the function knob to select the preferred program (see Automatic programs table).
4. Turn the temperature knob to select the weight (in grams) of the food to cook.

5. When preheating has finished,

START will flash. Introduce the food and then press the function knob to start cooking.

6. At the end, **Stop** is displayed and a buzzer sounds.

7. To deactivate the buzzer, press or turn one of the two knobs or open the door.

8. Press and hold the function knob for at least 3 seconds to exit the function.



It is possible to set programmed cooking in automatic programs.



A function can be interrupted at any time by pressing and holding the function knob for at least 3 seconds.



Use

Automatic programs table



MEAT (01 - 05)

Pr	Subcategory	Weight (g)	Level	Function	Temperature (°C)	Time (minutes)
01	Roast beef (cooked medium)	1300	2		200	56
02	Roast pork	800	2		190	88
03	Lamb (cooked medium)	2000	2		190	105
04	Veal	1000	2		190	80
05	Roast chicken (whole)	1000	2		200	80



FISH (06 - 07)

Pr	Subcategory	Weight (g)	Level	Function	Temperature (°C)	Time (minutes)
06	Fresh fish (whole)	500	2		160	35
07	Frozen fish	600	2		160	50



VEGETABLES (08 - 10)

Pr	Subcategory	Weight (g)	Level	Function	Temperature (°C)	Time (minutes)
08	Mixed grilled	500	4		250	15 + 8 ⁽¹⁾
09	Roast	1000	2		200	33
10	Roasted potatoes	1000	2		200	30

⁽¹⁾ For grilling, cooking food on both sides and referring to the times indicated in the table is recommended. The greater cooking time indicated always refers to the first side to be cooked starting from the raw food.



DESSERTS/PASTRIES (11 - 13)

Pr	Subcategory	Weight (g)	Level	Function	Temperature (°C)	Time (minutes)
11	Biscuits	500	2		160	23
12	Muffins	500	2		160	21
13	Tart	1000	2		170	43

EN



BREAD - PIZZA - PASTA (14 - 20)

Pr	Subcategory	Weight (g)	Level	Function	Temperature (°C)	Time (minutes)
14	Leavened bread (loaf)	1000	2		200	27
15	Pan baked pizza	1000	2		280	12
16	Stone baked pizza	500	1*		280	7
17	Pasta bake	2000	1		220	35
18	Lasagne	2000	1		230	40
19	Paella	500	2		190	25
20	Quiche	1000	1		200	40

(2) The stone must be placed at the bottom of the oven. The frozen pizza cooked on the stone does not require different cooking times depending on weight.



The times indicated in the tables do not include preheating times and refer to cooking whole pieces. If the food is cut into smaller portions, the cooking time decreases.



3.9 Secondary menu

The appliance also has a drop-down secondary menu allowing the user to:

- Activate or deactivate the Child lock.
- Activate or deactivate Showroom mode (which disables all the heating elements so that only the control panel works).
- Activate or deactivate Eco-Logic mode.
- Activate or deactivate Keep Warm mode.
- Activate or deactivate Eco-light mode.

With the appliance in Stand-By

1. Activate the internal light by turning the temperature knob quickly.
2. Press and hold the temperature knob down for at least 5 seconds.
3. Turn the temperature knob right or left to change the setting status (ON/OFF).
4. Press the temperature knob to move to the next mode.

Child lock mode

This mode allows the appliance to lock the controls automatically after one minute of normal operation without any intervention from the user.

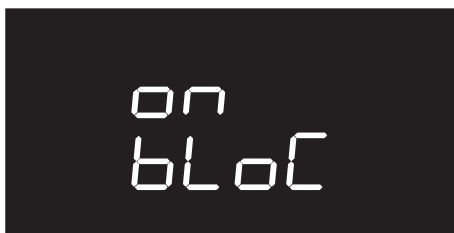
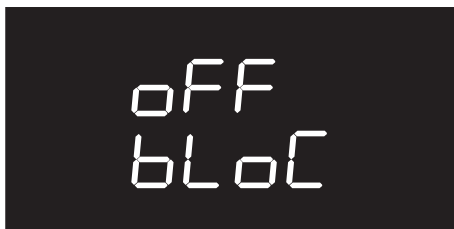

During normal operation it is indicated by the indicator light  coming on.

To release the lock temporarily during cooking, hold the temperature knob down for 5 seconds. One minute after the last setting the lock will become active again.



When the position of the knobs is changed, the display will show

 for a few seconds.



It is still possible to turn the appliance off instantaneously by pressing and holding the function knob down for 3 seconds when in child lock mode.



Showroom mode (for exhibitors only)

This mode allows the appliance to deactivate all heating elements, while keeping the control panel active.



To use the appliance normally, set this mode to OFF.



If the mode is active, the indicator light  lights up on the display.

Low power (Eco-logic) mode:

This mode allows the appliance to limit the power used.

Suitable for simultaneous use with further home appliances.

HI: normal power.



LO: low power.

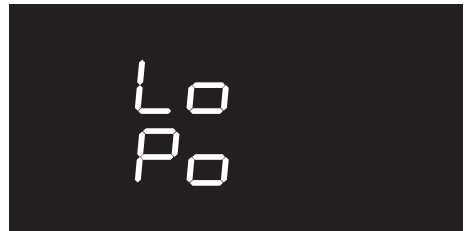

Activating eco-logic mode means that preheating and cooking times may be extended.



If the mode is active, the indicator light  lights up on the display.



Use

Keep Warm mode

This mode allows the appliance to keep cooked food warm (at low temperatures) for around an hour after cooking finishes with a cooking cycle for which a duration has been set (if this is not manually interrupted).

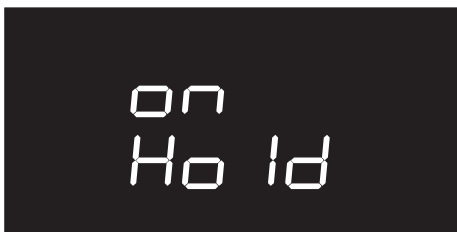

Eco-light mode

For greater energy savings, the light is automatically deactivated one minute from the start of cooking.



To stop the appliance from automatically deactivating the light after one minute, set this mode to OFF.



The manual off/on control is always available with both settings by turning the temperature knob to the right.



3.10 Using the storage compartment (if present)

There is a storage compartment located at the bottom of the cooker; this can be used to store pans or metal objects required for its use.

1. To open the storage compartment, press lightly on the left-hand side of the door until it clicks.

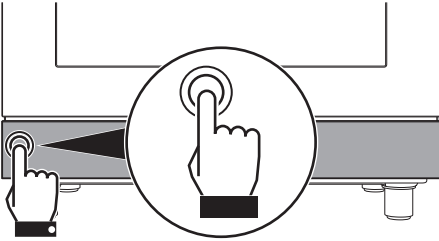

2. Gently release the storage compartment door.

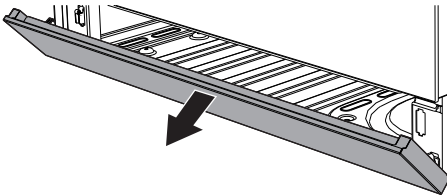

3. To close the storage compartment again, lift the door until it clicks.

3.11 Using the storage compartment

The storage compartment is at the bottom of the cooker. To open it, pull the handle towards you. It can be used to store cookware or metallic objects necessary when using the appliance.



Cleaning and maintenance

4 Cleaning and maintenance

4.1 Instructions



Improper use

Risk of damage to surfaces

- Do not use steam jets to clean the appliance.
- Do not use cleaning products containing chlorine, ammonia or bleach on parts made of steel or that have metallic surface finishes (e.g. anodizing, nickel- or chromium-plating).
- Do not use abrasive or corrosive detergents (e.g. scouring powders, stain removers and metallic sponges) on glass parts.
- Do not use rough or abrasive materials or sharp metal scrapers.
- Do not wash the removable components such as the hob grids, flame-spreader crowns and burner caps in a dishwasher.

Cleaning the hob

1. Pour some non-abrasive detergent on a damp cloth and wipe the surfaces.
2. Rinse thoroughly.
3. Dry with a soft cloth or a microfibre cloth.

Cleaning the hob grids, flame-spreader crowns and burner caps

1. Remove the components from the hob.
2. Clean with lukewarm water and non-abrasive detergent. Make sure to remove any encrustations.
3. Dry thoroughly with a soft cloth or a microfibre cloth.
4. Replace the components on the hob.



The continuous contact between the grids and the flame can cause modifications to the enamel over time in those parts exposed to heat. This is a completely natural phenomenon which has no effect on the operation of this component.

4.2 Cleaning the appliance



We recommend the use of cleaning products distributed by the manufacturer.

Recommendations for cleaning the hob

To keep the surfaces in good condition, they should be cleaned regularly after use. Let them cool first.



Cleaning the igniters and thermocouples

- If necessary, clean the igniters and thermocouples with a damp cloth.
- If there is any dry residue, remove it with a toothpick or needle.

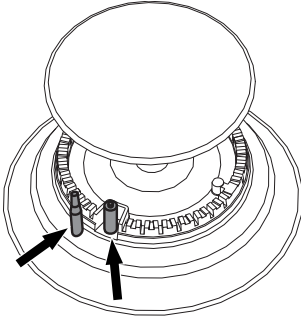

Cleaning the oven cavity

In order to keep your oven in the best possible condition, clean it regularly after letting it cool down.

Avoid letting food residue dry inside the oven cavity, as this could damage the enamel.

Take out all removable parts before cleaning.

For easier cleaning, we recommend removing:

- The door
- The rack/tray support frames
- Removable guides, where fitted
- The seal



In the event you are using specific cleaning products, we recommend running the oven at maximum temperature for 15-20 minutes in order to eliminate any residue.

4.3 Removing the door

For easier cleaning it is recommended to remove the door and place it on a tea towel.

To remove the door proceed as follows:

1. Open the door completely and insert two pins into the holes on the hinges indicated in the figure.

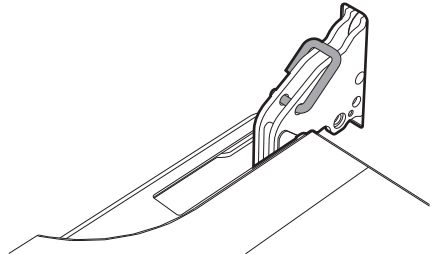



Cleaning and maintenance

2. Grasp the door on both sides with both hands, lift it forming an angle of around 30° and remove it.

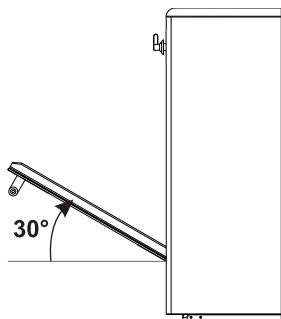

3. To reassemble the door, put the hinges in the relevant slots in the oven, making sure that grooved sections **A** are resting completely in the slots. Lower the door and once it is in place remove the pins from the holes in the hinges.

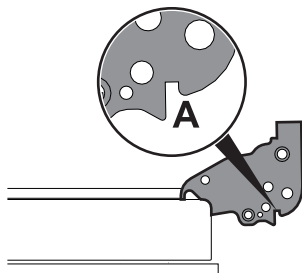

4.4 Cleaning the door glazing

The glass in the door should always be kept thoroughly clean. Use absorbent kitchen roll. In case of stubborn dirt, wash with a damp sponge and an ordinary detergent.

Removing the internal glass panes

For easier cleaning the internal glass panes of the door can be removed.

1. Pull the rear part of the internal glass pane gently upwards, following the movement indicated by the arrows (1).

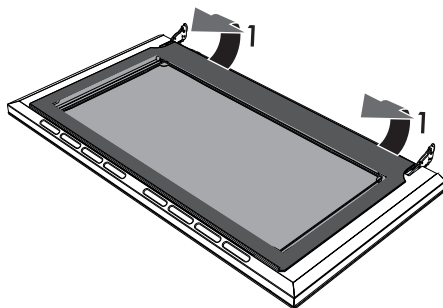

2. Extract the internal glass pane from the front strip (2) to remove it from the door.

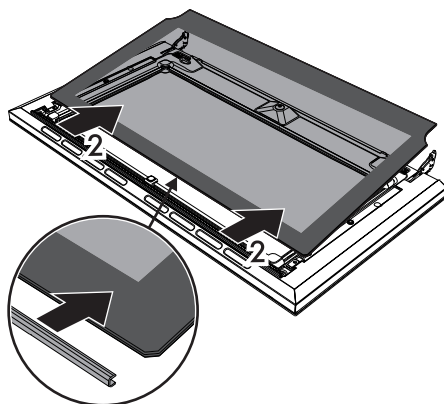



3. Remove the intermediate glass pane by lifting it upwards.

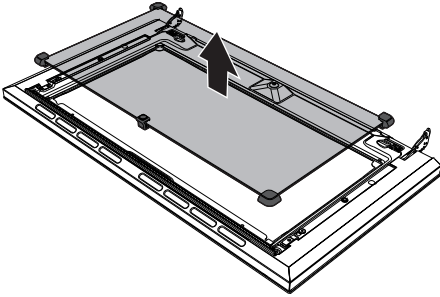

The pyrolytic model has two intermediate glass panes.

4. Clean the external glass pane and the panes removed previously. Use absorbent kitchen roll. In case of stubborn dirt, wash with a damp sponge and neutral detergent.

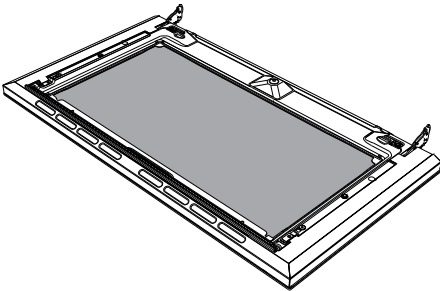

5. When you have finished cleaning, reinsert the intermediate glass pane in its housing in the door.
6. To reposition the internal glass pane, slide the upper part into the door strip and insert the two rear pins into their seats by pressing lightly.

Removing racks/trays support frames

Removing the rack/tray support frames enables the sides to be cleaned more easily.

To remove the rack/tray support frames:

- Pull the frame towards the inside of the oven to unhook it from its groove **A**, then slide it out of the seats **B** at the back.

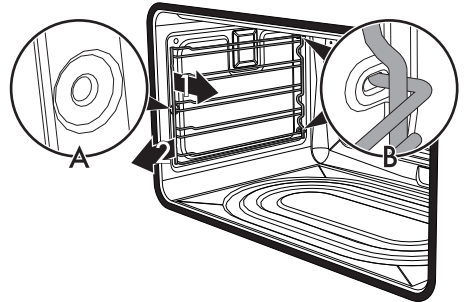

- When cleaning is complete, repeat the above procedures to put the rack/tray support frames back in.



Cleaning and maintenance

Manual deactivation of the door lock lever (pyrolytic models only)



Improper use

Danger of burns

- The following operations must always be performed with the appliance cold and switched off.
- Never attempt to manually deactivate the door lock lever during a pyrolytic cycle.

The door lock lever is located in the first slot on the left under the control panel, in the upper part of the front of the oven.

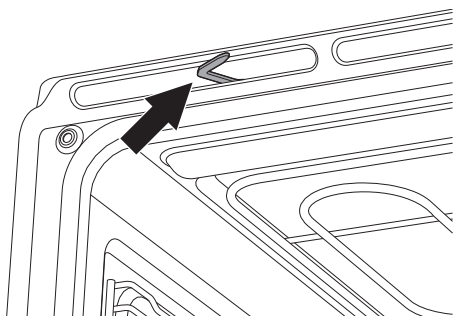

During normal cleaning operations, it is possible to accidentally activate the door lock lever.

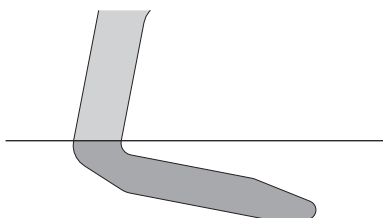

Door lock lever activated

(view from above)

1. Move the door lock lever to the right until it stops.

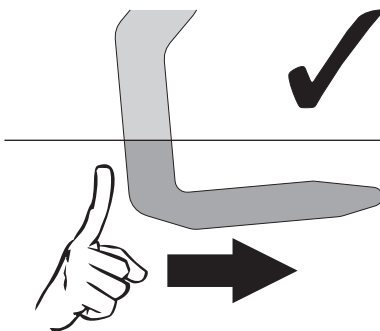

(view from above)

2. Gently release the door lock lever.

The mechanism's spring will return the door lock lever to the deactivated position.

To prevent damage to the mechanism, never attempt to deactivate the door lock lever by forcing it to the left.

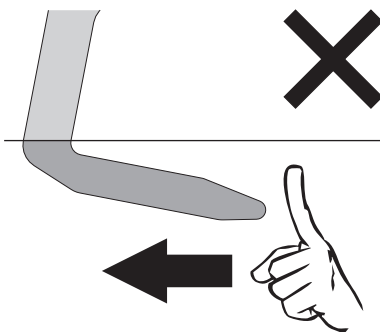

(view from above)



4.5 Vapor Clean (on some models only)



Vapor Clean is an assisted cleaning procedure which facilitates the removal of dirt. Thanks to this process, it is possible to clean the inside of the oven very easily. The dirt residues are softened by the heat and water vapour for easier removal afterwards.



Improper use
Risk of damage to surfaces

- Remove any food residues or large spills from previous cooking operations from the inside of the oven.
- Carry out assisted oven cleaning operations only when the oven is cold.

Preliminary operations

Before starting the Vapor Clean function:

- Completely remove all accessories from inside the oven.
- Remove the rack/tray support frames.
- Detach removable guides, where fitted.
- Close the door.

- Pour approximately 40 cc of water into the tray. Make sure it does not overflow out of the cavity.

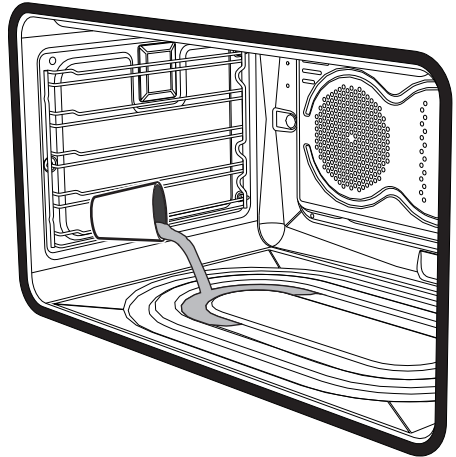

- Spray a water and washing up liquid solution inside the oven using a spray nozzle. Direct the spray against the side walls, upwards, downwards and towards the deflector.

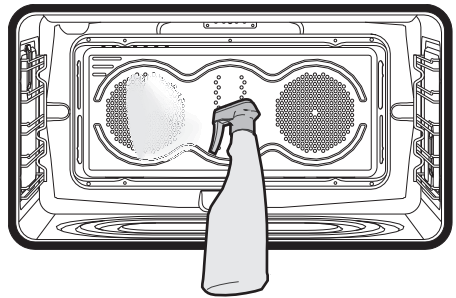

- Close the door.



We recommend spraying approx. 20 times at the most.



Cleaning and maintenance

Vapor Clean cycle setting

i If the internal temperature is greater than that required for the Vapor Clean cycle, the cycle will be stopped immediately and the message **STOP** will appear on the display. Let the appliance cool down before activating the assisted cleaning cycle.

1. Press and turn the function knob to select the Vapor Clean function . The duration and temperature of the cleaning cycle will appear on the display.

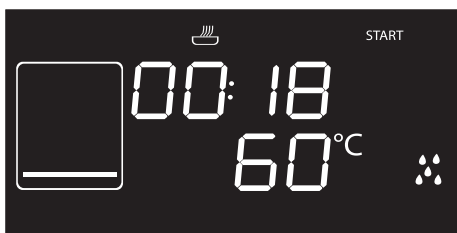

i The temperature and time parameters cannot be modified by the user.

2. Press the function knob to start the automatic cleaning cycle.

Programmed Vapor Clean cycle

Like for the normal cooking functions, it is also possible to set an end time for the Vapor Clean function.

1. After selecting the Vapor Clean function, press the temperature knob. The indicator light  starts flashing. The display shows the function end time.

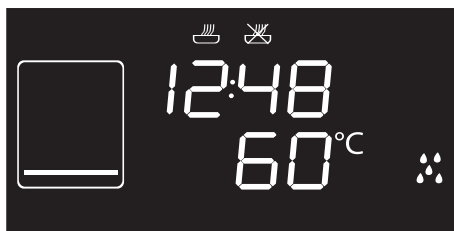

2. Turn the temperature knob right or left to delay the cooking end time.
3. Press the temperature knob to confirm the function end time.
4. Press the function knob. The appliance waits for the set start time.



End of the Vapor Clean cycle

At the end, **STOP** is displayed and a buzzer sounds.

1. To deactivate the buzzer, press or turn one of the two knobs or open the door.
2. Press and hold the function knob for at least 3 seconds to exit the function.
3. Open the door and wipe away the less stubborn dirt with a microfibre cloth.
4. Use a non-scratch sponge with brass filaments on hard to remove deposits.
5. In case of grease residues use specific oven cleaning products.
6. Remove the residual water inside the oven.

For improved hygiene and to avoid food being affected by any unpleasant odours, we recommend that the oven is dried using a fan-assisted function at 160°C for approximately 10 minutes.



We recommend wearing rubber gloves for these operations.



We recommend removing the door in order to make the manual cleaning of the parts that are difficult to reach easier.

4.6 Pyrolytic (on some models only)



Pyrolytic cleaning is an automatic high-temperature cleaning procedure which causes dirt to dissolve. Thanks to this process, it is possible to clean the inside of the oven very easily.



Improper use
Risk of damage to surfaces

- Remove any food residues or large spills from previous cooking operations from the inside of the oven.

Preliminary operations

Before starting the pyrolytic cycle:

- Clean the internal glass pane following the usual cleaning instructions.
- For very stubborn encrustations spray an oven cleaning product onto the glass (read the warnings on the product); leave for 60 minutes, then rinse and dry the glass using kitchen roll or a microfibre cloth.
- Completely remove all accessories from inside the oven.
- Remove the rack/tray support frames.
- Detach removable guides, where fitted.
- Close the door.



Cleaning and maintenance

Pyrolytic function setting

1. Select one of the cleaning functions **PYRO** or **ECO** with the function knob.
2. Turn the temperature knob to the right or to the left to set the cleaning cycle duration from a minimum of 2 hours to a maximum of 3 hours (except for the **PYRO** function whose duration is 120 minutes).
3. Press the temperature knob to start the pyrolytic cycle.



Recommended pyrolytic cycle duration:

- Light dirt: 2 hours.
- Medium dirt: 2 ½ hours.
- Heavy dirt: 3 hours.

Pyrolytic cycle

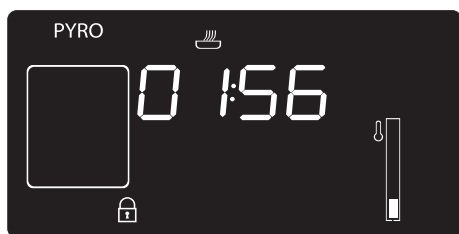

1. The display shows **PYRO** or **ECO** and the remaining time to indicate that the appliance is carrying out the automatic cleaning cycle.

2. Two minutes after the pyrolytic cycle has started the door is locked (the door lock indicator light  comes on) by a device that prevents the door from being opened.



It is not possible to select any function once the door lock device has been activated.

3. At the end of the pyrolytic cycle, the door remains locked as long as the temperature inside the oven cavity returns to safety levels. Wait for the oven to cool down and collect the residue deposited inside it using a damp microfibre cloth.



During the first pyrolytic cycle, unpleasant odours may occur due to the normal evaporation of oily manufacturing substances. This is an absolutely normal phenomenon which disappears after the first pyrolytic cycle.





During the pyrolytic cycle the fans produce a more intense level of noise due to a greater rotation speed. This is an absolutely normal operation, intended to provide more effective heat dispersal. At the end of the pyrolytic cycle, the fans will continue to operate for long enough to avoid overheating the walls of adjacent units and the front of the oven.



If the pyrolytic cycle gives unsatisfactory results at minimum duration, it is recommended to set a longer time for successive cleaning cycles.

Setting of programmed pyrolytic cycle

It is possible to program the pyrolytic cycle start time like all other cooking functions.

1. After selecting the pyrolytic cycle duration, press the temperature knob. The display shows the current time and the  indicator light comes on.
2. Turn the temperature knob to set the time at which you wish to complete the pyrolytic cycle.
3. After a few seconds, the  and  indicator lights will turn on steadily and the appliance will now wait for the set start time to start the cleaning cycle.



It is not possible to select any function once the door lock device has been activated.

4.7 Extraordinary maintenance

Replacing the internal light bulb



Live parts
Danger of electrocution

- Unplug the appliance.



The oven is fitted with a 40W light bulb.

1. Completely remove all accessories from inside the oven.
2. Remove the rack/tray support frames.
3. Remove the bulb cover using a tool (e.g. a screwdriver).



Pay attention not to scratch the oven cavity enamel.

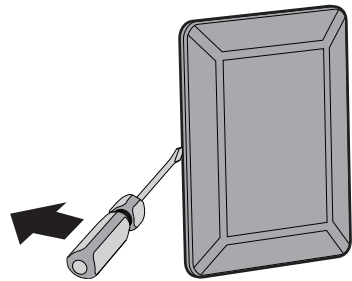



Cleaning and maintenance

- Slide out and remove the light bulb.

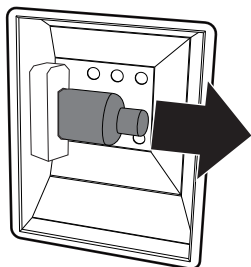

Do not touch the halogen light bulb directly with your fingers, but wrap it in insulating material.

- Fit the new light bulb.
- Refit the cover. Ensure the moulded part of the glass (A) is facing the door.

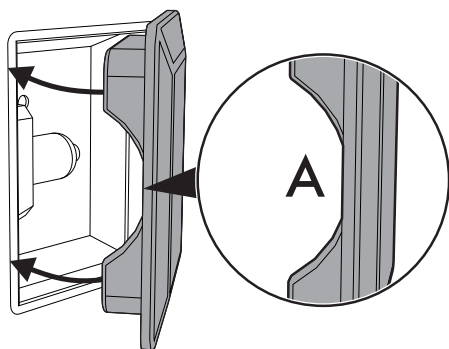

- Press the cover completely down so that it attaches perfectly to the bulb support.

Removing and installing the door seal (not on pyrolytic models)

To remove the seal:

- Unhook the clips located in the 4 corners and in the centre, then pull the seal outwards.

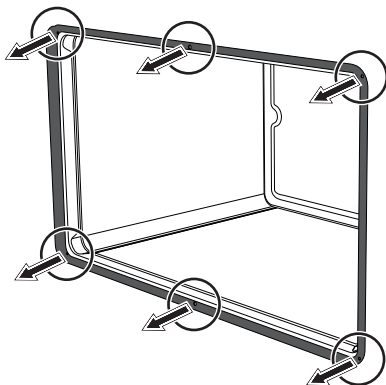

To refit the seal:

- Hook the clips located in the 4 corners and in the centre onto the seal.

Seal maintenance tips

The seal should be soft and elastic.

- To keep the seal clean, use a non-abrasive sponge and wash with lukewarm water.



What to do if...

The appliance is not working properly:

- The switch is defective: check the fuse box to see whether the switch is in working order.
- Loss of power: check that the appliance indicator lights are operational.

The gas burner does not light:

- Loss of power or moisture in the igniters: light the gas burner with a lighter or match.

The oven does not heat up:

- Defective fuse: check and replace the switch if necessary.
- The function knob has not been set: set the function knob.
- Check whether it has been set to "showroom" mode (for further details see "Secondary menu").

All food prepared in the oven burns within a short time:

- Defective thermostat: contact an Authorised Service Centre

The door glass mists up when the oven is hot:

- Completely normal behaviour caused by the difference in temperature which has no effect on the oven's performance.

The display is completely off:

- Check the mains power supply.
- Check whether an omnipolar switch upstream of the appliance supply line is in the "ON" position.

The controls do not respond:

- Check whether "child lock" mode has been set (for further details see "Secondary menu").

The cooking times are longer than those indicated in the table:

- Check whether it has been set in "ecologic" mode (for further details see "Secondary menu").

The display shows "ERR4":

- The door lock has not properly attached to the door. This might be because the door was accidentally opened during the door lock activation. Switch the appliance off and on again, waiting a few minutes before selecting a new cleaning cycle.

If the door is opened during a fan assisted function, the fan stops:

- This is not a fault. It is a normal operation of the appliance, useful when cooking foods in order to avoid excessive heat escaping. When the door is closed, the oven will return to normal operation.



Cleaning and maintenance

(pyrolytic models only) After the (pyrolytic) automatic cleaning cycle it is not possible to select a function:

- Verify whether the door lock has deactivated. If it has not, the appliance is fitted with a safety device that does not allow functions to be selected while the door lock is active. This is because the temperature inside the oven is still too high to permit any type of cooking.



If the problem has not been resolved or in the case of other types of fault, contact your local technical support centre.



If other ERRx error messages are indicated:

Note down the error message, function and set temperature and contact your local technical support centre.



5 Installation

5.1 Gas connection



Gas leak
Danger of explosion

- After carrying out any operation, check that the tightening torque of gas connections is between 10 Nm and 15 Nm.
- If required, use a pressure regulator that complies with current regulations.
- At the end of the installation, check for any leaks with a soapy solution, never with a flame.
- Installation using a hose must be carried out so that the length of the hose does not exceed 2 metres when fully extended for steel hoses and 1.5 metres for rubber hoses.
- The hoses should not come into contact with moving parts and should not be crushed in any way.

General information

Connection to the gas mains can be made using a continuous wall steel hose in compliance with the guidelines established by the standards in force. For supplying it with other types of gas, see chapter "5.2 Adaptation to different types of gas". The gas inlet connection is threaded 1/2" external gas (ISO 228-1).

Connection with a rubber hose

Verify that all following conditions are met:

- the hose is fixed to the hose connection with safety clamps;
- no part of the hose is in contact with hot walls (max. 50 °C);
- the hose is not under traction or tension and has no kinks or twists;
- the hose is not in contact with sharp objects or sharp corners;
- if the hose is not perfectly airtight and leaks gas, do not try to repair it; replace it with a new hose;
- verify that the hose is not past its expiry date (serigraphed on the hose itself).

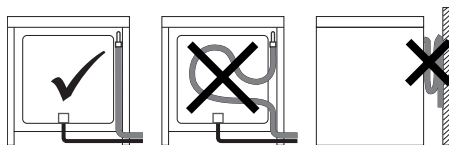

Make the connection to the gas mains using a rubber hose whose specifications comply with current standards (verify that the reference standard is stamped on the hose).

Carefully screw the hose connector **3** to the appliance's gas connector **1** (1/2" thread ISO 228-1), placing the seal **2** between them. The hose connector **4** can also be screwed to the hose connector **3**, depending on the diameter of the gas hose used.



Installation

After having tightened the hose connector(s), push the gas hose **6** onto the hose connector and secure it with the clamp **5** that is compliant with the standard in force.

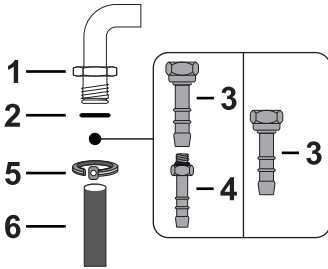

Carefully screw the connector **3** to the gas connector **1** of the appliance, placing the seal **2** between them.

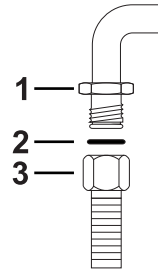

Connection with a steel hose with bayonet fitting

Carry out the connection to the gas mains using a steel hose with bayonet fitting compliant with B.S. 669. Apply insulating material to the thread of the gas hose connector **4** and then tighten the adapter **3**. Screw the assembly to the movable connector **1** of the appliance, placing the supplied seal **2** between them.



Connection using a rubber hose complying with current standards is only permitted if the hose can be inspected along its entire length.



The inside diameter of the hose must be 8 mm for LPG and 13 mm for Natural gas and Town gas.

Connection with a steel hose

Make the connection to the gas mains using a continuous wall steel hose whose specifications comply with the applicable standard.

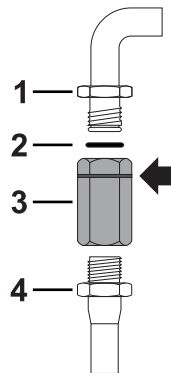



Connection with a steel hose with conical fitting

Make the connection to the gas mains using a continuous wall steel hose whose specifications comply with the applicable standard.

Carefully screw the hose connector **3** to the appliance's gas connector **1** ($\frac{1}{2}$ " thread ISO 228-1), placing the supplied seal **2** between them. Apply insulating material to the thread of connector **3**, then tighten the steel hose **4** to the connector **3**.

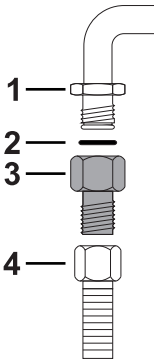

Connection to LPG

Use a pressure regulator and make the connection on the gas cylinder following the guidelines set out in the standards in force.

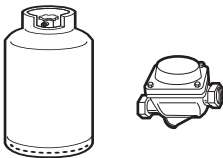

The supply pressure must comply with the values indicated in the table in "Burner and nozzle characteristics tables".

Gas connection extension cord (pyrolytic models only)

For pyrolytic models, the supplied gas connection extension cord must be installed:

1. Undo the screw **A** at the back of the appliance, under the gas connection.
2. Use the just removed screw **A** to fasten the supplied bracket **B** to the back of the cabinet.

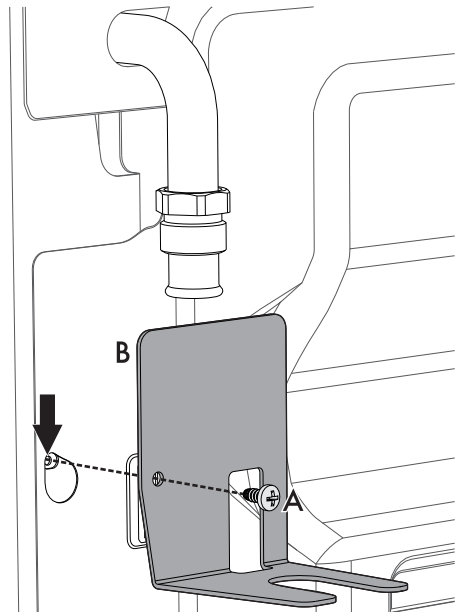

EN



Installation

3. Carefully screw the connector **3** to the gas extension cord **1** of the appliance, placing the seal **2** between them.

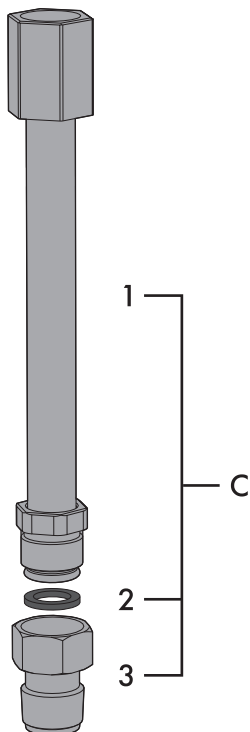

4. Carefully screw the assembled extension cord **C** to the gas connector **D** of the appliance, placing the seal **2** between them.

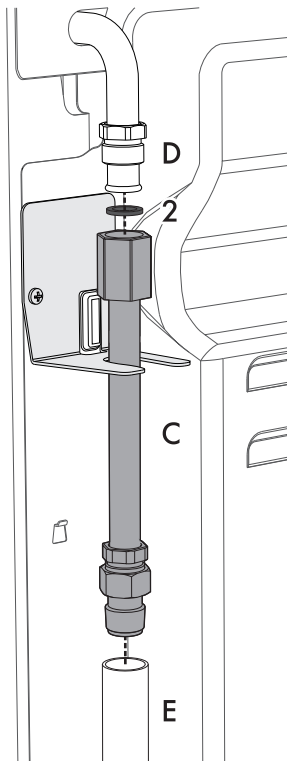

5. Apply some insulating material on the thread of the assembled extension cord **C**, then tighten the hose **E**.



Room ventilation

The appliance should be installed in rooms that have a permanent air supply in accordance with the standards in force. The room where the appliance is installed must have enough air flow for the regular combustion of gas and the necessary air change in the room itself. The air vents, protected by grilles, must be the right size to comply with current regulations and positioned so that no part of them is obstructed, not even partially.

The room must be kept adequately ventilated in order to eliminate the heat and humidity produced by cooking: In particular, after prolonged use, you are recommended to open a window or to increase the speed of any fans.

Extraction of the combustion products

The combustion products may be extracted by means of hoods connected to a natural draught chimney whose efficiency is certain or via forced extraction. An efficient extraction system requires precision planning by a specialist qualified in this area and must comply with the positions and clearances indicated by the applicable standards.

When the job is complete, the installer must issue a certificate of conformity.

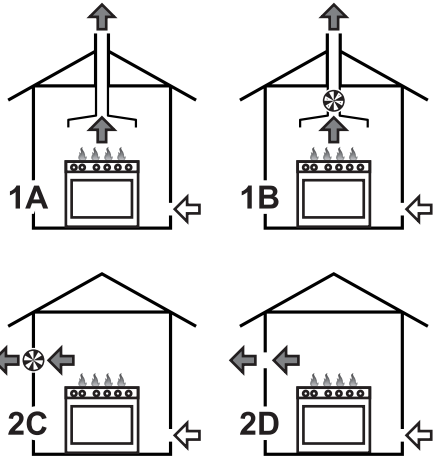

- 1 Extraction using a hood
- 2 Extraction without a hood

- A Single natural draught chimney
- B Single chimney with extractor fan
- C Directly outdoors with wall- or window-mounted extractor fan
- D Directly outdoors through wall

- Air
- Combustion products
- Extractor fan



Installation

5.2 Adaptation to different types of gas

In case of operation with other types of gas, the burner nozzles must be changed and the minimum flame adjusted on the gas cocks.

Replacing nozzles

1. Remove the grids, burner caps and flame-spreader crowns to access the burner cups.
2. Replace the nozzles using a 7 mm spanner according to the gas to be used (see Burner and nozzle characteristics tables).

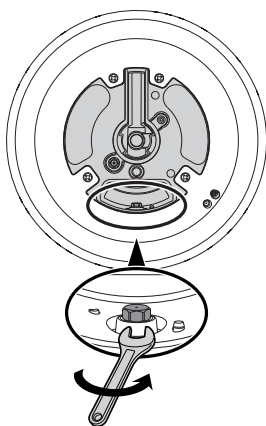

3. Replace the burners in their respective housings.

Adjusting the minimum setting for natural or town gas

Light the burner and turn it to the minimum position. Extract the gas cock knob and turn the adjustment screw next to the tap rod (depending on the model) until the correct minimum flame is achieved.

Refit the knob and verify that the burner flame is stable. Turn the knob rapidly from the maximum to the minimum setting: The flame should not go out. Repeat the operation on all gas cocks.

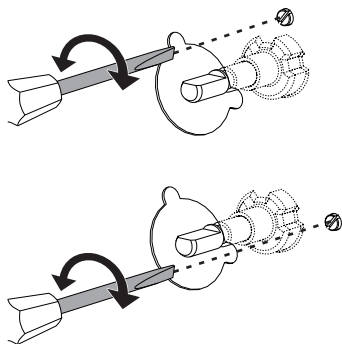



Adjusting the minimum setting for LPG

Tighten the screw located at the side of the tap rod clockwise all the way.



Following adjustment to a gas other than the one originally set in the factory, replace the gas setting label on the appliance with the one corresponding to the new gas. The label is inserted inside the nozzle pack (where present).

Lubricating the gas cocks

Over time the gas taps may become difficult to turn and get blocked. Clean them internally and replace the lubrication grease.



Lubrication of the gas taps should be performed by a specialised technician.

Dimensions

Position of gas and electrical connections.

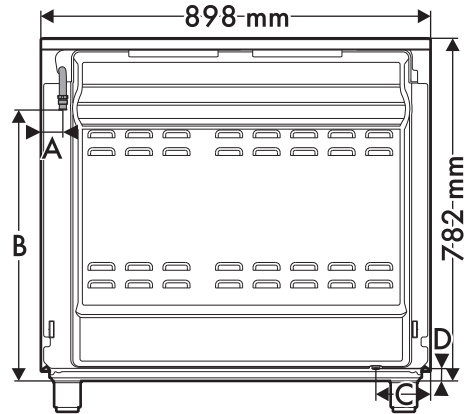

A	40 mm
B	618 mm
C	124 mm
D	12 mm

EN



Installation

Gas types and Countries

Gas types		IT	GB-IE	FR-BE	DE	AT	ES	PT	SE	RU	DK	PL	HU
1 Natural Gas G20													
G20	20 mbar	•	•		•	•	•	•	•	•	•	•	
G20/25	20/25 mbar			•									
2 Natural Gas G20													
G20	25 mbar												•
3 Natural Gas G25.1													
G25.1	25 mbar												•
4 Natural Gas G25													
G25	20 mbar				•								
5 Natural Gas G2.350													
G2.350	13 mbar											•	
6 LPG G30/31													
G30/31	28/37 mbar		•	•			•			•			
G30/31	30/37 mbar	•						•					
G30/31	30/30 mbar								•		•		
7 LPG G30/31													
G30/31	37 mbar											•	
8 LPG G30/31													
G30/31	50 mbar				•	•							
9 Town gas G110													
G110	8 mbar	•							•		•		



It is possible to identify the available gas types based on the country the appliance is to be installed in. Refer to the heading number to identify the correct values in the "Burner and nozzle characteristics tables".



Burner and nozzle characteristics tables

1 Natural gas G20 – 20 mbar	AUX	SR	R	UR2
Rated heating capacity (kW)	1.0	1.8	3.0	4.2
Nozzle diameter (1/100 mm)	72	97	120	145
Pre-chamber (printed on nozzle)	(X)	(Z)	(H9)	(F3)
Reduced flow rate (W)	400	500	800	1200
2 Natural gas G20 – 25 mbar	AUX	SR	R	UR2
Rated heating capacity (kW)	1.1	1.8	2.9	4.2
Nozzle diameter (1/100 mm)	72	94	110	145
Pre-chamber (printed on nozzle)	(X)	(Z)	(H8)	(H3)
Reduced flow rate (W)	400	500	800	1200
3 Natural gas G25.1 – 25 mbar	AUX	SR	R	UR2
Rated heating capacity (kW)	1.0	1.8	3.0	4.1
Nozzle diameter (1/100 mm)	77	100	134	152
Pre-chamber (printed on nozzle)	(F1)	(Y)	(F3)	(F3)
Reduced flow rate (W)	400	500	800	1200
4 Natural gas G25 – 20 mbar	AUX	SR	R	UR2
Rated heating capacity (kW)	1.0	1.8	3.0	4.0
Nozzle diameter (1/100 mm)	77	100	134	165
Pre-chamber (printed on nozzle)	(F1)	(Y)	(F3)	(H3)
Reduced flow rate (W)	400	500	800	1200
5 Natural gas G2.350 – 13 mbar	AUX	SR	R	UR2
Rated heating capacity (kW)	1.0	1.75	3.0	3.8
Nozzle diameter (1/100 mm)	94	120	165	190
Pre-chamber (printed on nozzle)	(Y)	(Y)	(F3)	(F3)
Reduced flow rate (W)	400	500	800	1200
6 Liquid gas – G30/G31 30-37 mbar	AUX	SR	R	UR2
Rated heating capacity (kW)	1.0	1.75	3.0	4.0
Nozzle diameter (1/100 mm)	50	65	85	100
Pre-chamber (printed on nozzle)	-	-	-	-
Reduced flow rate (W)	400	500	800	1300
Rated flow rate G30 (g/h)	73	127	218	291
Rated flow rate G31 (g/h)	71	125	214	286



Installation

7 LPG G30/G31 – 37 mbar	AUX	SR	R	UR2
Rated heating capacity (kW)	1.1	1.9	3.0	4.2
Nozzle diameter (1/100 mm)	50	65	81	95
Pre-chamber (printed on nozzle)	-	-	-	-
Reduced flow rate (W)	450	550	900	1500
Rated flow rate G30 (g/h)	80	138	218	305
Rated flow rate G31 (g/h)	79	136	214	300
8 LPG G30/G31 – 50 mbar	AUX	SR	R	UR2
Rated heating capacity (kW)	1.0	1.8	3.0	4.1
Nozzle diameter (1/100 mm)	43	58	74	80
Pre-chamber (printed on nozzle)	(H2)	(M)	(Z)	(F4)
Reduced flow rate (W)	400	500	1000	1500
Rated flow rate G30 (g/h)	73	131	218	298
Rated flow rate G31 (g/h)	71	129	214	293
9 Town gas G110 – 8 mbar	AUX	SR	R	UR2
Rated heating capacity (kW)	1.0	1.75	2.8	3.4
Nozzle diameter (1/100 mm)	145	185	260	340
Pre-chamber (printed on nozzle)	/8	/2	/3	0190
Reduced flow rate (W)	400	500	800	1200

The nozzles not provided are available at Authorised Service Centres.



5.3 Positioning



**Heavy appliance
Crushing hazard**

- Position the appliance into the cabinet cutout with the help of a second person.



**Pressure on the door
Risk of damage to the appliance**

- Never use the oven door to lever the appliance into place when fitting.
- Avoid exerting too much pressure on the oven door when open.
- Do not use the handle to lift or move the appliance.



**Heat production during appliance
operation
Risk of fire**

- Veneers, adhesives or plastic coatings on adjacent furniture should be temperature-resistant (not less than 90°C).

Dimensions

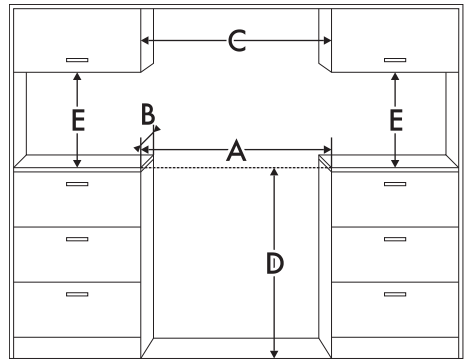

A	900 mm
B	600 mm
C*	900 mm
D	900 mm
E	400 mm

* Minimum cabinet width (=A).



Installation

General information

This appliance may be installed next to walls, one of which must be higher than the worktop, at a minimum distance of **X** mm from the side of the appliance, as shown in figures A and C relative to the installation classes.

Any wall units positioned above the worktop must be at a minimum distance of at least **Y** mm. If a hood is installed above the hob, refer to the hood instruction manual to ensure the correct clearance is left.

X	150 mm
Y	750 mm

Depending on the type of installation, this appliance belongs to classes:

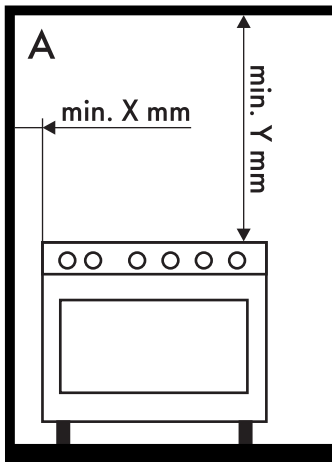

A - Class 1

(Free-standing appliance)

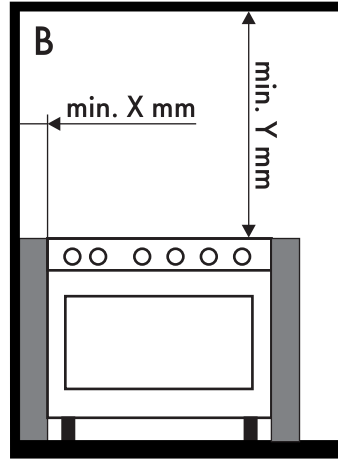

B - Class 2 subclass 1

(Built-in appliance)

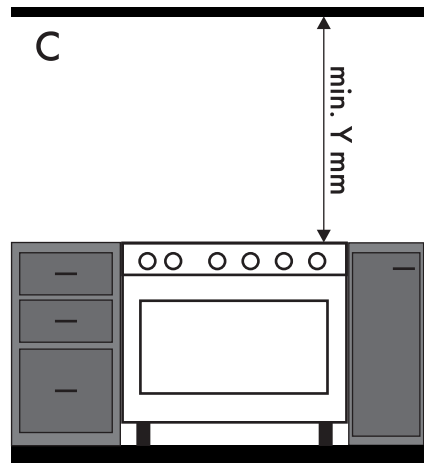

C - Class 2 subclass 1

(Built-in appliance)



The appliance must be installed by a qualified technician and according to the regulations in force.



Positioning and levelling



**Heavy appliance
Risk of damage to the appliance**

- Insert the front feet first and then the rear ones.
- After making the gas and electrical connections, screw on the four feet supplied with the appliance.

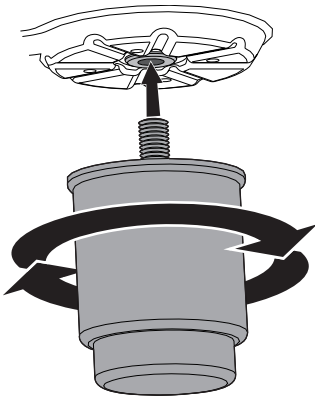

The appliance must sit level on the floor to ensure stability.

- Screw or unscrew the bottom part of the foot until the appliance is stable and level on the floor.

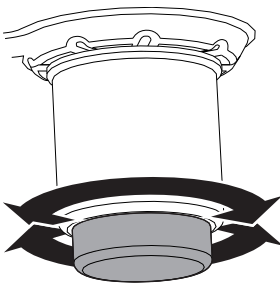

Fastening to the wall



The anti-tip devices must be installed in order to prevent the appliance from tipping over.

1. Screw the wall fastening plate to the rear of the appliance.

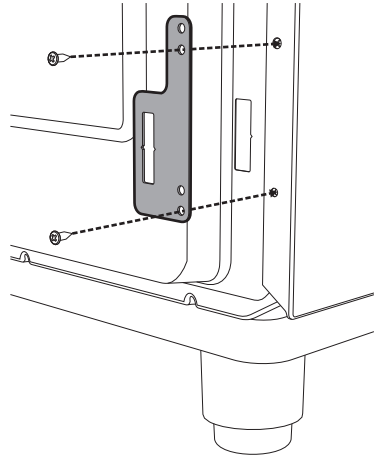

2. Adjust the height of the 4 feet.

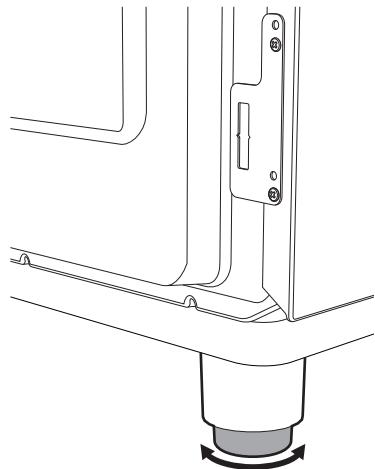



Installation

3. Assemble the fastening bracket.

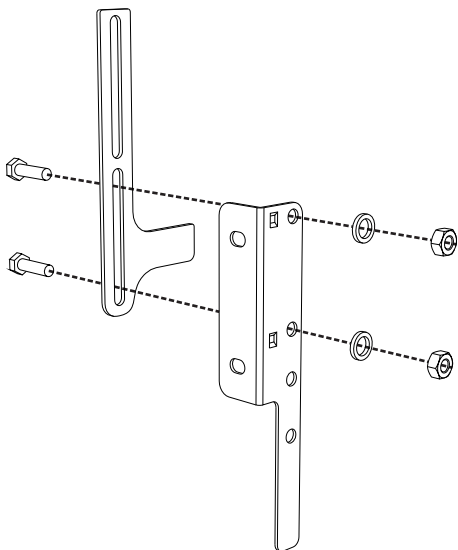

4. Align the base of the hook on the fastening bracket with the base of the slot on the wall fastening plate.

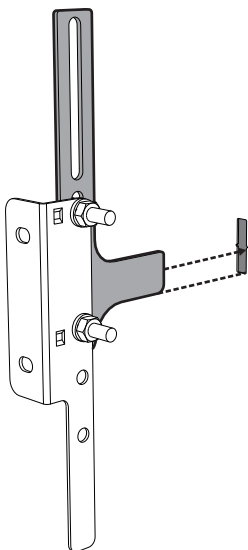

5. Align the base of the fastening bracket with the ground and tighten the screws to fix the measurements.

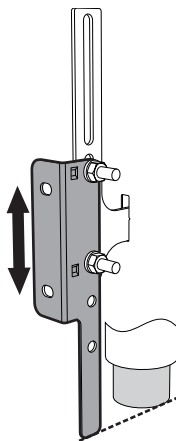

6. Use 50 mm for the distance from the side of the appliance to the bracket holes.

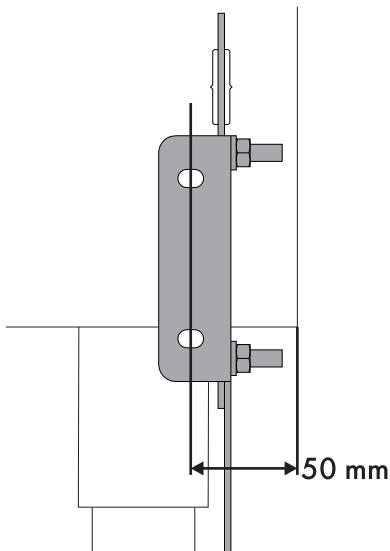



7. Move the bracket onto the wall and mark the position of the holes to be drilled in the wall.

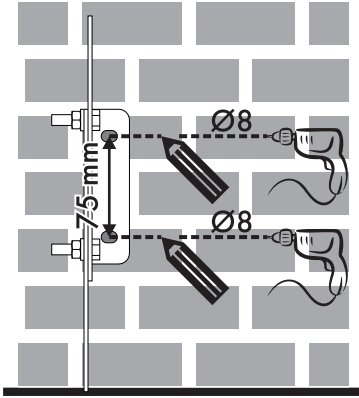

8. After drilling the holes in the wall, use wall plugs and screws to fasten the bracket to the wall.
9. Push the cooker towards the wall, and at the same time, insert the bracket in the plate fastened to the rear of the appliance.

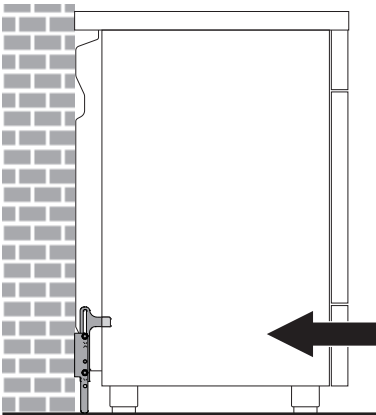

Fastening to the ground



If fastening to the ground, contact the nearest Authorised Service Centre

EN

Installing the front skirting

The front skirting must always be positioned and secured correctly on the appliance.

1. Use a screwdriver to remove the front screws underneath the storage compartment.

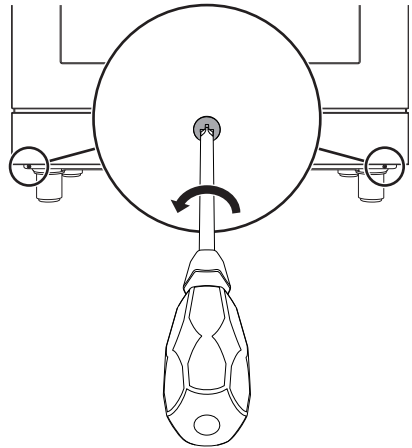



Installation

2. Position the front skirting at the bottom of the appliance and line up the side holes of the front skirting with the holes on the base of the appliance.

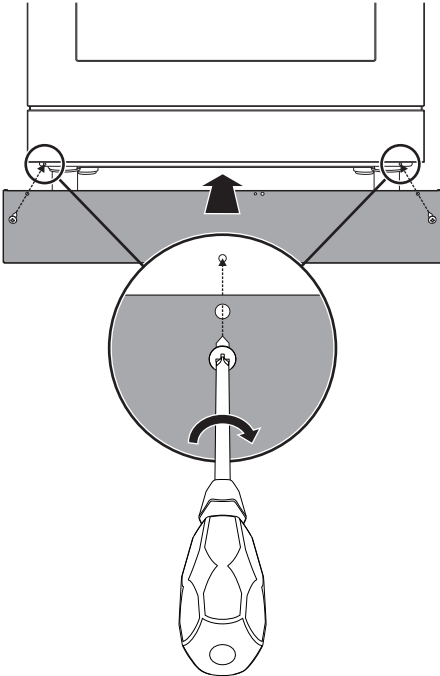

3. Fasten the front skirting to the appliance using the previously removed screws.

Installing the side skirting

After installing the front skirting, the side skirting can be fastened correctly to the appliance.

1. Use a screwdriver to remove the front screws underneath the storage compartment.

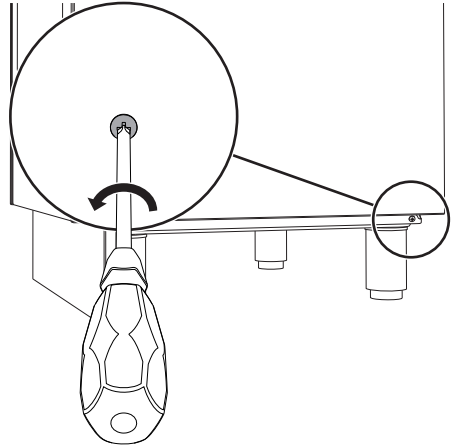

2. Position the side skirting on the lower side section of the appliance below the storage compartment.
3. Insert the tabs on the side skirting into the slots on the rear part of the front skirting.

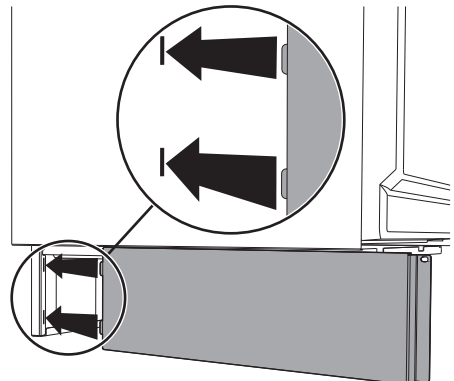



- Line up the hole on the side skirting with the rear hole on the base of the appliance.

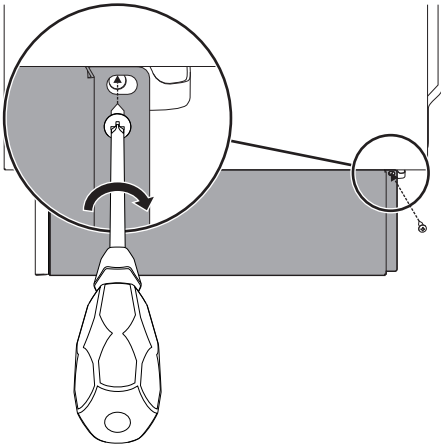

- Fasten the side skirting to the appliance using the previously removed screw.
- Repeat the operations described above for the other side skirting section.

Assembling the upstand

i The supplied upstand is an integral part of the product and it is recommended to fasten it to the appliance prior to installation.

The upstand must always be positioned and secured correctly on the appliance.

- Loosen the 4 screws (**A**) on the back of the hob (2 for each side) using a screwdriver.
- Place the upstand on the worktop.
- Align the slots of the upstand (**B**) with the screws (**A**).

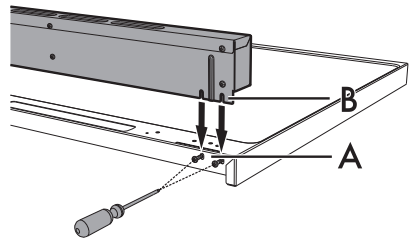

- Secure the upstand to the worktop by tightening the 4 screws previously loosened.



Installation

5.4 Electrical connection



**Power voltage
Danger of electrocution**

- Have the electrical connection performed by authorised technical personnel.
- Use personal protective equipment.
- The appliance must be connected to earth in compliance with electrical system safety standards.
- Disconnect the mains power supply.
- Do not pull the cable to remove the plug.
- Use cables withstanding a temperature of at least 90°C.
- The tightening torque of the screws of the terminal supply wires must be 1.5 - 2 Nm.

General information

Check the grid characteristics against the data indicated on the plate.

The identification plate bearing the technical data, serial number and brand name is visibly positioned on the appliance.

Do not remove this plate for any reason.

Perform the ground connection using a wire that is 20 mm longer than the other wires.

The appliance can work in the following modes:

Pyrolytic model

- **220-240 V 1N~**

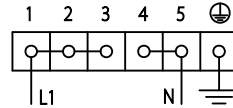

3 x 2.5 mm² three-core cable.

- **380-415 V 2N~**

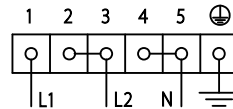

4 x 1.5 mm² four-core cable.

- **380-415 V 3N~**

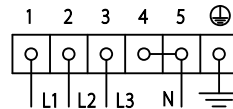

5 x 1.5 mm² five-core cable.



Access to the terminal board (pyrolytic models only)

To connect the power supply cable, you must access the terminal board on the rear casing:

1. Remove the screws fastening the plate to the rear casing.

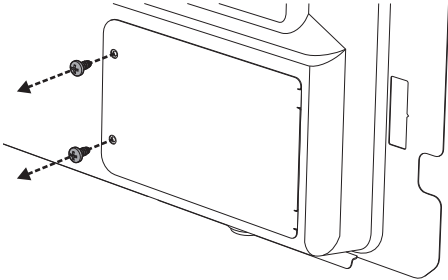

2. Gently rotate the plate and remove it from its seat.

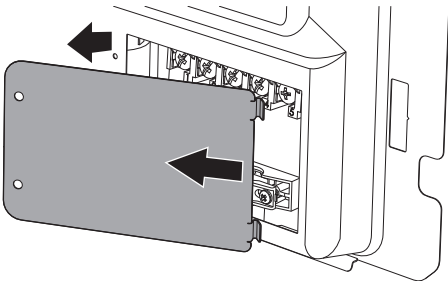

3. Proceed with installation of the power supply cable.

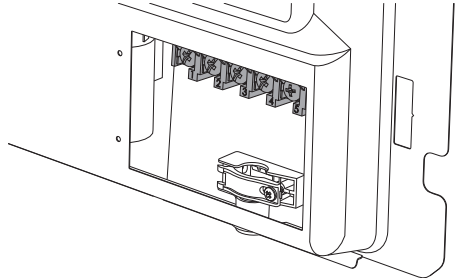

It is recommended to slacken off the cable clamp screw before installing the power supply cable.

4. When you have finished, reposition the plate on the rear casing and fasten it in place with the previously removed screws.

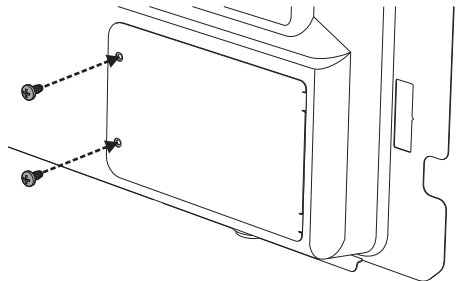



Installation

The appliance can work in the following modes:

Multifunction model

- **220-240 V 1N~**

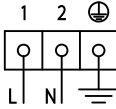

3 x 1.5 mm² three-core cable.



The values indicated above refer to the cross-section of the internal conductor.



The aforementioned power cables are sized taking into account the coincidence factor (in compliance with standard EN 60335-2-6).

Fixed connection

Fit the power line with an omnipolar circuit breaker in compliance with installation regulations.

The circuit breaker should be located near the appliance and in an easily reachable position.

Connection with plug and socket

Make sure that the plug and socket are of the same type.

Avoid using adapters and shunts as these could cause overheating and a risk of burns.

5.5 Instructions for the installer

- The plug must be accessible after installation. Do not bend or trap the power cable.
- The appliance must be installed according to the installation diagrams.

- Do not try to unscrew or force the threaded elbow of the fitting. You may damage this part of the appliance, which may void the manufacturer's warranty.
- Use soap and water to check for gas leaks on all connections. **DO NOT** use naked flames to find leaks.
- Turn on all the burners separately and at then all together to make sure that the gas valve, burner and ignition are working properly.
- Turn the burner knobs to the minimum position and check that the flame is stable for each individual burner and all the burners together.
- If the appliance does not work correctly after having carried out all the checks, contact your local Authorised Service Centre.
- Once the appliance has been installed, please explain to the user how to use it correctly.

For New Zealand only:

- If this cooking range is to be connected to a new or upgraded electrical installation, then it must be connected to the supply by a supply cord fitted with:
 - An appropriately rated plug that is compatible with the socket-outlet fitted to the final sub-circuit in the fixed wiring that supplies this cooking range;
- Or:
 - An appropriately rated installation male connector that is compatible with the installation female connector fitted to the final sub-circuit in the fixed wiring that supplies this cooking range.