

Contents

1	Instructions	4
1.1	General safety instructions	4
1.2	Appliance purpose	8
1.3	Manufacturer liability	8
1.4	This user manual	8
1.5	Identification plate	8
1.6	Disposal	8
1.7	How to read the user manual	9
2	Description	10
2.1	General Description	10
2.2	Control panel	11
2.3	Other parts	12
2.4	Advantages of steam cooking	12
2.5	Available accessories	13
2.6	Other cooking containers	14
3	Use	15
3.1	Instructions	15
3.2	First use	16
3.3	Using the accessories	16
3.4	Using the oven	17
3.5	Cooking advice	37
3.6	Special functions	39
3.7	Secondary menu	47
4	Cleaning and maintenance	50
4.1	Instructions	50
4.2	Cleaning the surfaces	50
4.3	Cleaning the door	51
4.4	Cleaning the inside of the oven	53
4.5	Extraordinary maintenance	61
5	Installation	62
5.1	Electrical connection	62
5.2	Cable replacement	62
5.3	Positioning	63

TRANSLATION OF THE ORIGINAL INSTRUCTIONS

We advise you to read this manual carefully, which contains all the instructions for maintaining the appliance's aesthetic and functional qualities.

For further information on the product: www.smeg.com



Instructions

1 Instructions

1.1 General safety instructions

Risk of personal injury

- During use the appliance and its accessible parts become very hot. Never touch the heating elements during use.
- Protect your hands by wearing oven gloves when moving food inside the oven.
- Never try to put out a fire or flames with water: Turn off the appliance and smother the flames with a fire blanket or other appropriate cover.
- This appliance may be used by children aged at least 8 and by people of reduced physical, sensory or mental capacity, or lacking in experience in the use of electrical appliances, provided that they are supervised or instructed by adults who are responsible for their safety.
- Children must not play with the appliance.
- Keep children under the age of eight at a safe distance unless they are constantly supervised.
- Keep children under the age of 8 away from the appliance when it is in use.
- Cleaning and maintenance must not be carried out by unsupervised children.
- Fats and oils can catch fire if they overheat. Do not leave the appliance unattended while preparing foods containing oils or fats. If fats or oils catch fire, never put water on them. Place the lid on the pan and turn off the relevant cooking zone.
- The cooking process must always be monitored. A short cooking process must be continuously monitored.
- Do not cook dishes containing large quantities of strong alcoholic beverages. Alcohol vapours in the oven could catch fire.
- Do not insert pointed metal objects (cutlery or utensils) into the slots in the appliance.
- Do not pour water directly onto very hot trays.



- Keep the oven door closed during cooking.
- If you need to move food or at the end of cooking, open the door 5 cm for a few seconds, let the steam come out, then open it fully.
- **DO NOT USE OR STORE FLAMMABLE MATERIALS NEAR THE APPLIANCE.**
- **DO NOT USE AEROSOLS IN THE VICINITY OF THIS APPLIANCE WHILE IT IS IN USE.**
- Switch off the appliance immediately after use.
- Do not clean the appliance immediately after turning it off – wait for it to cool down first.
- **DO NOT MODIFY THIS APPLIANCE.**
- Always use any necessary/required personal protective equipment (PPE) before performing any work on the appliance (installation, maintenance, positioning or movement).
- Before performing any work on the appliance, switch off the power supply.
- Have qualified personnel carry out installation and assistance interventions according to the standards in force.
- Do not try to repair the appliance yourself or without the intervention of a qualified technician.
- Do not pull the cable to remove the plug.
- If the power supply cable is damaged, contact technical support immediately and they will replace it.

Risk of damaging the appliance

- Do not use cleaning products containing chlorine, ammonia or bleach on parts made of steel or that have metallic surface finishes (e.g. anodizing, nickel- or chromium-plating).
- Racks and trays should be inserted as far as they will go into the side guides. The mechanical safety locks that prevent them from being removed must face downwards and towards the back of the oven cavity.
- Do not seat on the appliance.



Instructions

- Do not use steam jets to clean the appliance.
- Do not obstruct ventilation openings and heat dispersal slots.
- Never leave the appliance unattended during cooking operations where fats or oils could be released, as these could then heat up and catch fire. Be very careful.
- Never leave objects on the cooking surface.
- **DO NOT USE THE APPLIANCE AS A SPACE HEATER FOR ANY REASON.**
- Do not spray any spray products near the appliance.
- Do not use plastic cookware or containers when cooking food.
- Do not put sealed tins or containers in the oven.
- Remove all trays and racks which are not required during cooking.
- Do not cover the bottom of the oven cavity with aluminium or tin foil sheets.
- Do not place pans or trays directly on the bottom of the oven cavity.
- If you wish to use greaseproof paper, place it so that it will not interfere with the hot air circulation inside the oven.
- Do not use the open door to rest pans or trays on the internal glass pane.
- Do not use steam jets to clean the appliance.
- Do not remove the seal on the face of the oven.
- Do not use rough or abrasive materials or sharp metal scrapers.
- Never use the oven door to lever the appliance into place when fitting.
- Avoid exerting too much pressure on the oven door when open.
- Do not use the handle to lift or move the appliance.



Installation

- THIS APPLIANCE **MUST NOT BE INSTALLED** IN A BOAT OR CARAVAN.
- The appliance must not be installed on a pedestal.
- Position the appliance into the cabinet cut-out with the help of a second person.
- To avoid potential overheating, the appliance must not be installed behind a decorative door or a panel.
- Have the electrical connection performed by authorised technical personnel.
- The appliance must be connected to earth in compliance with electrical system safety standards.
- Use cables withstanding a temperature of at least 90 °C.
- The tightening torque of the screws of the terminal supply wires must be 1.5 - 2 Nm.

For this appliance

- Take care because steam may not be visible at certain temperatures.
- Keep the oven door closed during cooking.
- Open the appliance door carefully during or after cooking.
- When steaming, always place the tray below the perforated tray in order to catch any drips.
- Do not cover the bottom of the oven cavity with aluminium or tin foil sheets.
- The base of the oven and the evaporation tray must always be left free.
- Dishes must be heat and steam resistant.
- Do not use silicone moulds when steaming.
- Ensure that the appliance is switched off before replacing the bulb.
- Do not rest any weight or sit on the open door of the appliance.
- Take care that no objects are stuck in the doors.



Instructions

1.2 Appliance purpose

- This appliance is intended for cooking food in the home environment. Every other use is considered improper.
- The appliance is not designed to operate with external timers or with remote-control systems.

1.3 Manufacturer liability

The manufacturer declines all liability for damage to persons or property caused by:

- Use of the appliance other than that specified;
- Failure to comply with the instructions in the user manual;
- Tampering with any part of the appliance;
- The use of non-original spare parts.

1.4 This user manual

This user manual is an integral part of the appliance and must therefore be kept in its entirety and within the user's reach for the whole working life of the appliance.

Read this user manual carefully before using the appliance.

1.5 Identification plate

The identification plate bears the technical data, serial number and brand name of the appliance. Do not remove the identification plate for any reason.

1.6 Disposal



This appliance must be disposed of separately from other waste (Directives 2002/95/EC, 2002/96/EC, 2003/108/EC). The appliance does not contain substances in quantities sufficient to be considered hazardous to health and the environment, in accordance with current European directives.

To dispose of the appliance:

- Cut the power supply cable and remove it along with the plug.



Power voltage

Danger of electrocution

- Disconnect the mains power supply.
- Unplug the appliance.



- Deliver the appliance to the appropriate recycling centre for electrical and electronic equipment waste, or return it to the retailer when purchasing an equivalent product, on a one for one basis.

Our appliances are packaged in non-polluting and recyclable materials.

- Deliver the packing materials to the appropriate recycling centre.



Plastic packaging Danger of suffocation

- Do not leave the packaging or any part of it unattended.
- Do not let children play with the plastic bags.

1.7 How to read the user manual

This user manual uses the following reading conventions:

Instructions



General information on this user manual, on safety and final disposal.

Description



Description of the appliance and its accessories.

Use



Information on the use of the appliance and its accessories, cooking advice.

Cleaning and maintenance



Information for proper cleaning and maintenance of the appliance.

Installation



Information for the qualified technician: Installation, operation and inspection.



Safety instructions



Information



Advice

1. Sequence of instructions for use.

- Standalone instruction.



Description

2 Description

2.1 General Description

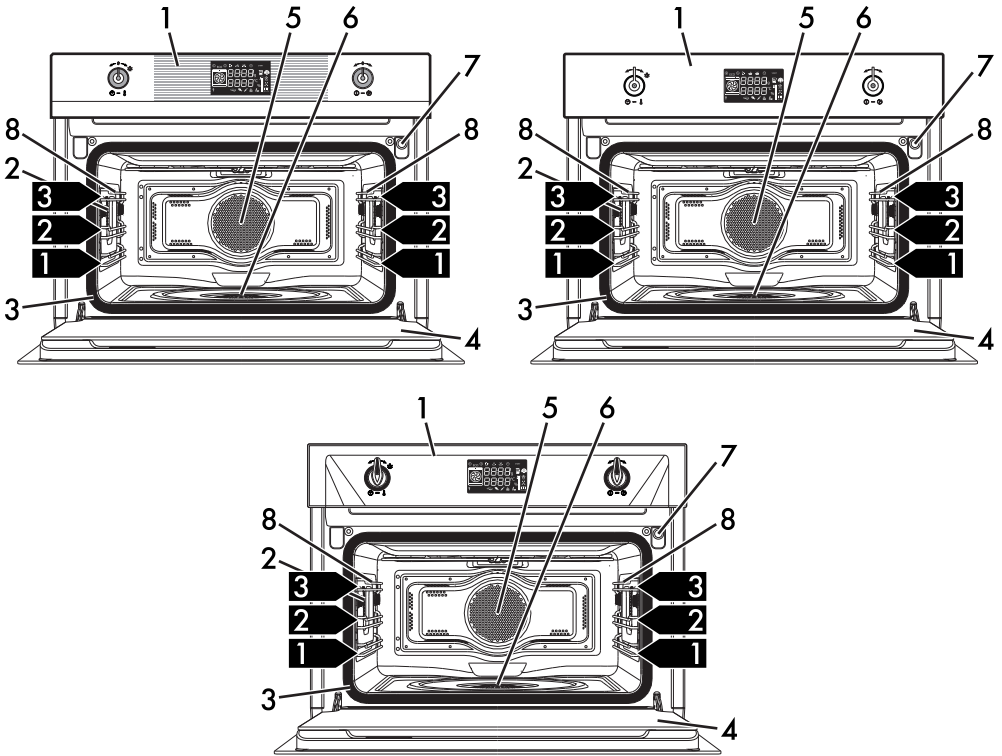

- 1 Control panel
- 2 Oven light
- 3 Seal
- 4 Door
- 5 Fan

- 6 Evaporation tray
- 7 Water supply tube
- 8 Rack support frames
- 1,2,3...** Frame shelf



2.2 Control panel

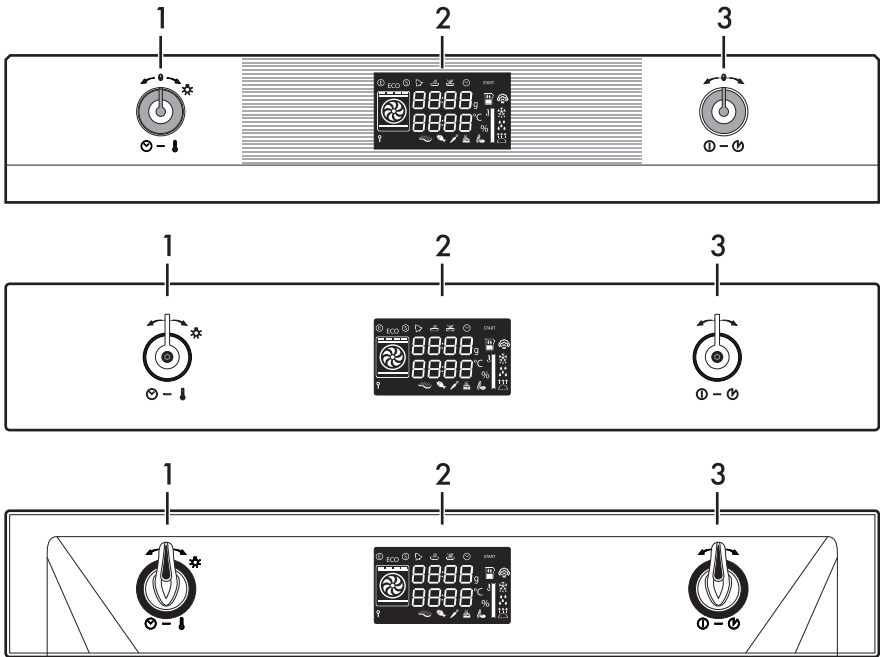

1 Temperature knob

This knob can be used to select:

- The cooking temperature
- The duration of a function
- Programmed cooking procedures
- The current time
- The turning on or off of the light inside the appliance.

3 Function knob

This knob can be used to:

- Turn the appliance on and off
- Select a function
- Temporarily start or stop a function.



To stop the active function and switch off the appliance, press the function knob for a few seconds.

2 Display

Displays the current time, the function, the selected cooking temperature and any time set.





Description

2.3 Other parts

Interior lighting

The appliance's interior lighting comes on:

- When the door is opened (on some models only).
- When any function is selected, apart from the Vapor Clean  function.
- When no function is selected or during a cooking function, turn the temperature knob briefly to the right towards the  symbol to manually activate or deactivate internal lighting.



In order to save energy, the light turns off after a minute at the start of cooking (this function can be deactivated via the secondary menu).



When the door is open, it is not possible to turn off the interior lighting (on some models only).

Shelves

The appliance features shelves to position trays and racks at different heights. The insertion heights are indicated from the bottom upwards (see 2.1 General Description).

Cooling fan

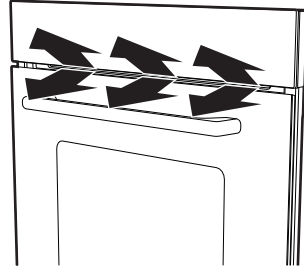

The fan cools the appliance and comes into operation during cooking.

The fan causes a steady outflow of air from above the door which may continue for a brief period of time even after the appliance has been turned off.

2.4 Advantages of steam cooking

The steam cooking system cooks any type of food much more delicately.

It is also ideal for defrosting foods rapidly, for heating up foods without hardening or drying them out, and for naturally removing salt from foodstuffs preserved with salt.



2.5 Available accessories

Jug

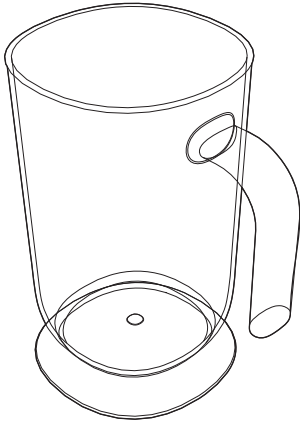

For holding liquids during reservoir filling and emptying.

Perforated tray

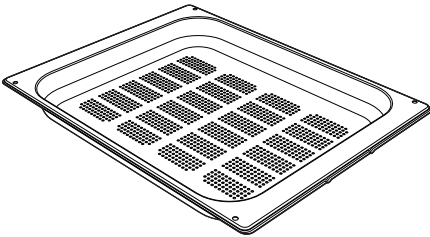

Useful for steaming fish and vegetables.

Tray

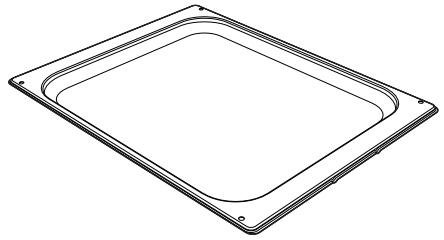

Useful when cooking cakes (with cooking times of less than 25 minutes or without steam), rice, beans and cereals. It is also essential for collecting liquids produced by steaming or defrosting of foods contained in the perforated trays above.

Tray rack

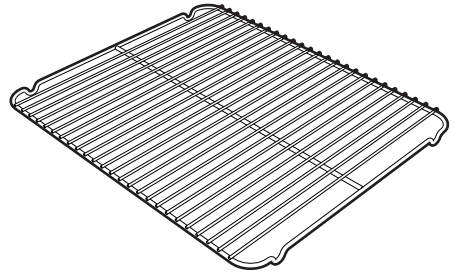

To be placed over the top of the oven tray; for cooking foods which may drip.



Description

Rack

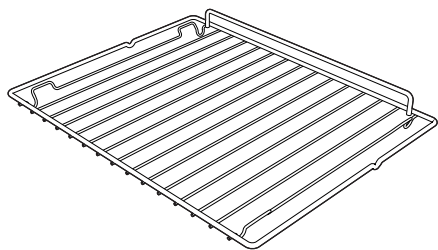

Useful for supporting containers with food during cooking.

Sponge

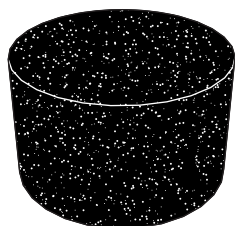

Useful for removing condensation from inside the oven.

Evaporation tray cover

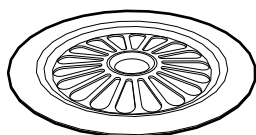

Evenly distributes steam inside the oven.

i Some models are not provided with all accessories.

i The appliance accessories intended to come into contact with food are made of materials that comply with the provisions of current legislation.

i Original supplied and optional accessories can be requested to Authorised Assistance Centres. Use only original accessories supplied by the manufacturer.

2.6 Other cooking containers

- You may also use your own containers for cooking, as long as they are resistant to high temperatures.
- For steam cooking, the use of metal containers is recommended. Metal facilitates better distribution of heat to the foods.
- It is normal for metal containers to deform somewhat during high-temperature cooking, but they will return to their original shape when they cool down.
- Thick ceramic plates may require more heat than normal. Longer cooking times may be necessary.



3 Use

3.1 Instructions



High temperature inside the oven during use
Danger of burns

- Keep the oven door closed during cooking.
- Protect your hands by wearing oven gloves when moving food inside the oven.
- Open the appliance door carefully during or after cooking.
- Take care because steam may not be visible at certain temperatures.
- Do not cook dishes containing large quantities of strong alcoholic beverages. Alcohol vapour inside the oven could ignite.
- Do not touch the heating elements inside the oven.
- Do not pour water directly onto very hot trays.
- Do not allow children to approach the appliance when it is in operation.



Improper use

Risk of damage to enamelled surfaces

- When steaming, always place the tray below the perforated tray in order to catch any drips.
- Do not cover the bottom of the oven cavity with aluminium or tin foil sheets.
- The base of the oven and the evaporation tray must always be left free.
- Dishes must be heat and steam resistant.
- Do not use silicone moulds when steaming.
- If you wish to use greaseproof paper, place it so that it will not interfere with the hot air circulation inside the oven.
- Do not place pans or trays directly on the bottom of the oven cavity.
- Do not pour water directly onto very hot trays.



Use



High temperature inside the oven during use

Danger of fire or explosion

- Do not spray any spray products near the appliance.
- Do not use or leave flammable materials near the appliance.
- Do not use plastic cookware or containers when cooking food.
- Do not put sealed tins or containers in the oven.
- Do not leave the appliance unattended during cooking operations where fats or oils could be released.
- Remove all trays and racks which are not required during cooking.

3.2 First use

1. Remove any protective film from the outside or inside of the appliance, including accessories.
2. Remove any labels (apart from the technical data plate) from the accessories and from the oven cavity.
3. Remove and wash all the appliance accessories (see 4 Cleaning and maintenance).

4. Heat the empty oven at the maximum temperature for at least 20 minutes to burn off any residues left by the manufacturing process (see 3.4 Using the oven).
5. You must set the current time in order to start using the appliance (see "Setting the time").

3.3 Using the accessories

Racks and trays

Racks and trays have to be inserted into the side guides until they come to a complete stop.

- The mechanical safety locks that prevent the racks and trays from being taken out accidentally must face downwards and towards the back of the oven cavity.

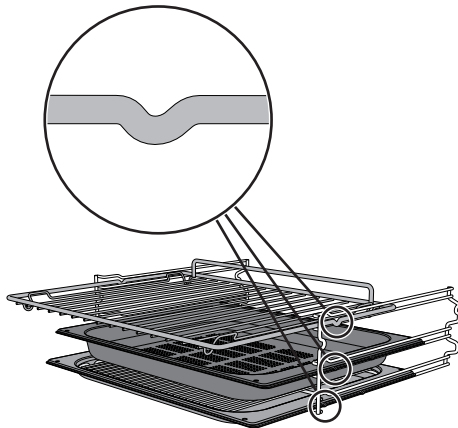



2+1 configuration

If you intend to use the perforated tray for steam cooking, this must be positioned on the second runner while the tray must be positioned on the first runner. This allows the liquids to be collected separately from the food that is being cooked (2 + 1 configuration, see "Automatic programs table").

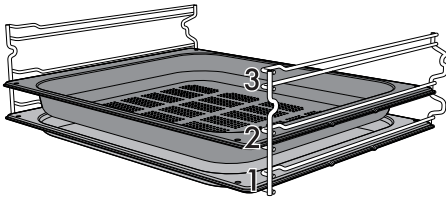

Gently insert racks and trays into the oven until they come to a stop.



Clean the trays before using them for the first time to remove any residues left by the manufacturing process.

Tray rack



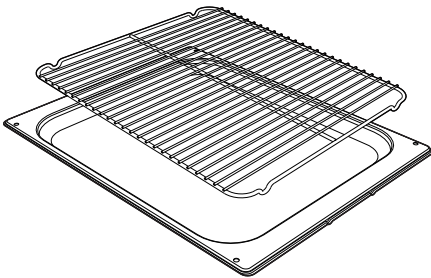





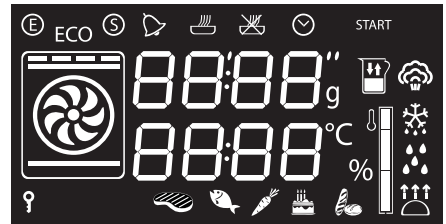



The tray rack has to be inserted into the tray. In this way fat can be collected separately from the food which is being cooked.



3.4 Using the oven

Display



-  Eco-logic indicator light
-  Showroom indicator light
-  Minute minder timer indicator light
-  Timed cooking indicator light
-  Programmed cooking indicator light
-  Clock indicator light
-  Child lock indicator light
-  Temperature indicator light
-  Reservoir level indicator light
-  Steam indicator light
-  Defrost indicator light
-  Vapor Clean indicator light
-  Proving indicator light



Use

Setting the time

When using the appliance for the first time, or after a power failure, the symbol

 will flash on the display. To be able to start any cooking function, the current time must be set.

1. Turn the temperature knob to set the displayed time (keep the knob turned to produce a faster increase or decrease).
2. Press the temperature knob.
3. Turn the temperature knob to set the minutes (keep the knob turned to produce a faster increase or decrease).
4. Press the temperature knob to finish adjustment.



It may become necessary to change the current time, for example for daylight saving time. From the stand-by position, keep the temperature knob turned to the right until the hours flash.

It is not possible to change the time if a function is active.

Operating modes

Stand-by: When no function is selected, the display shows the current time.

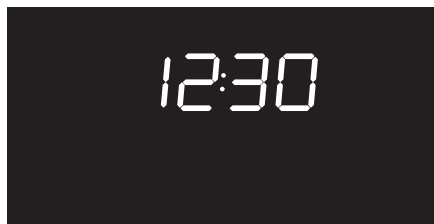

ON: When a function is activated, the display shows the parameters set such as temperature, duration and temperature reached.



Steaming foods

Each time the temperature knob is pressed during a function, the parameters will be cycled through in the following order.



Timed cooking duration



Temperature







Programmed cooking time







Traditional cooking

Each time the temperature knob is pressed during a function, the parameters will be cycled through in the following order.

-  Temperature
-  Minute minder
-  Timed cooking duration
-  Programmed cooking time (if timed cooking is set)

Combination cooking

Each time the temperature knob is pressed during a function, the parameters will be cycled through in the following order.

-  Timed cooking duration
-  Temperature
-  Steam percentage
-  Programmed cooking time.

In all modes it is possible to modify the value by turning the temperature knob to the left or right. Keep the knob turned to produce a faster increase or decrease.

Steam function settings

i Do not place food or any other object directly on the bottom of the oven. The base of the oven and the evaporation tray must always be left free.

1. Place the food inside the oven.
2. Press the function knob to activate the appliance. The timed cooking indicator light  will flash.

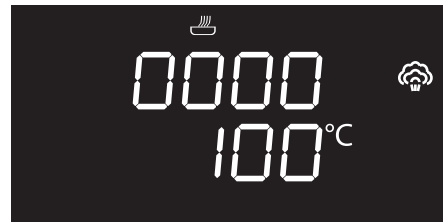

3. Turn the temperature knob to the right or left to set the steaming duration from 00:01 to 02:00. Keep the knob turned for a fast increase or decrease

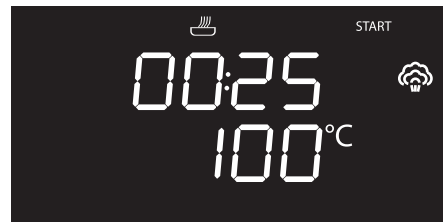



Use

- Press the temperature knob to confirm the required cooking duration. The timed cooking indicator light  remains on steadily, while the temperature indication **100°C** starts flashing.
- If you wish to modify the default temperature (100°C), turn the temperature knob to the right or left until you reach the required value.



At this point it is possible to set programmed cooking.

i Programmed cooking is the function which allows cooking to be stopped at an established time depending on the time set by the user, after which the appliance will switch off automatically.

If you do not wish to set timed cooking, just wait a few seconds until the indicator light

START starts flashing, otherwise continue from step 10.

If you do wish to set timed cooking, proceed as follows:

- While the programmed cooking indicator light  is flashing, turn the temperature knob to the right or left to set the cooking end time.

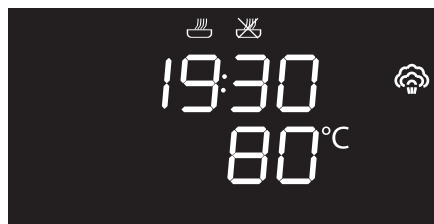

- Press the temperature knob to confirm the cooking end time. The programmed cooking indicator light  remains on steadily.
- After a few seconds, the indicator light **START** flashes on the display.

i The minimum temperature which can be set is 30°C. Each movement of the temperature knob changes the value by 5°C.

- Press the temperature knob to confirm the cooking temperature set. The temperature indication remains steady, while the programmed cooking indicator light  starts flashing.

 If cooking has just been performed with temperatures greater than 100°C, you must wait for the oven to cool in order to use the steam function.



10. Press the function knob. A request to fill the reservoir with water is shown on the display.



Filling the reservoir



- Use cold tap water which is not too hard, softened water or still mineral water.
- Do not use distilled water, tap water with a high chloride content (> 40 mg/l), or other liquids.

11. Fill the supplied jug or other suitable container with sufficient water for the cooking duration.
12. Open the oven door.
13. Rest the jug or container on the open door.



Note: the jug or container with the water must have a gross weight lower than 5 kg.

14. Extract the tube from its seat and insert its end in the jug or container until it reaches all the way to the bottom.

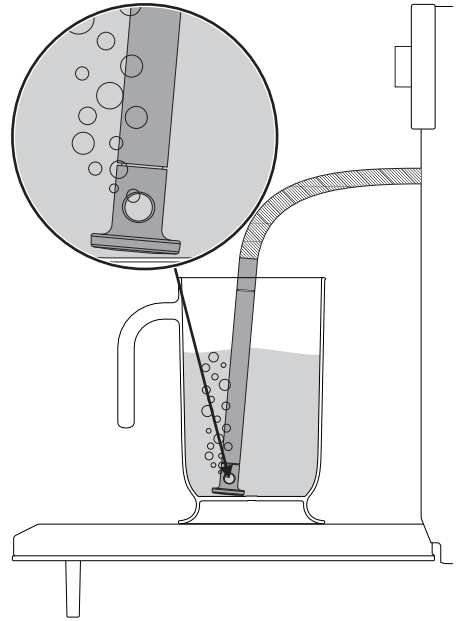

15. Press the function knob to start drawing water into the appliance's reservoir.





Use

i The appliance will automatically draw the quantity of water necessary for cooking on the basis of the set duration.

i In the event that the water runs out, the appliance will automatically stop the cooking process, a buzzer will sound and the display will show a request to fill the reservoir with water.

16. When the appliance has finished taking in water, shake the tube to remove any residual water.

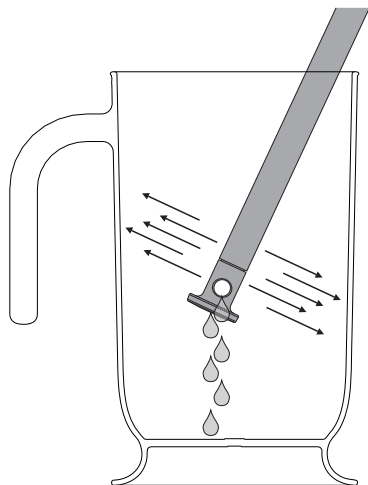

17. Return the tube to its original position, remove the jug/container of solution and close the door.

i When the door is closed, an automatic system will automatically draw in any residual water in the tube to avoid drips. A bubbling noise may be heard; this is completely normal.

18. Press the function knob to start steaming.

 Cooking can be interrupted at any time by pressing and holding the function knob for a few seconds.

i Each time the door is opened, the function in progress will stop and then automatically restart when the door is closed again.



Preheating stage

Steaming is always preceded by a preheating stage, which allows the appliance to heat up to cooking temperature.

The temperature reached flashes to indicate that this stage is in progress.





When preheating finishes, the temperature reached remains lit steadily, a buzzer sounds and cooking proceeds automatically.



Modifying the set data

During operation, it is possible to modify the cooking duration:

19. When the timed cooking indicator light  is lit steadily and cooking is in progress inside the appliance, press the temperature knob. The timed cooking indicator light  will start flashing.

- i** If you set a longer cooking time than that previously set - meaning that the water added to the reservoir will be insufficient - the indicator light  will flash on the display for a few seconds. Cooking will proceed regardless, but when the reservoir is empty a request to add water will be shown on the display.



20. Turn the temperature knob right or left to alter the pre-set cooking time.

- i** Towards the end, the appliance automatically switches off its heating elements in order to finish cooking using the residual heat inside the oven cavity.









Use

Modifying programmed cooking



If programmed cooking is set, after modifying the cooking time, the end of cooking time must be re-set.

21. When the timed cooking  and programmed cooking  indicator lights are lit steadily and the appliance is waiting for cooking to start, press the temperature knob. The timed cooking indicator light  will start flashing.
22. Turn the temperature knob right or left to alter the pre-set cooking time.
23. Press the temperature knob again. The timed cooking indicator light  switches off and the programmed cooking indicator light  starts flashing. The display shows the cooking end time.
24. Turn the temperature knob right or left to delay the cooking end time.
25. After a few seconds the timed cooking  and programmed cooking  indicator lights stop flashing and programmed cooking restarts with the new settings.

End of the steam function

When cooking finishes, a buzzer will sound and the following screens will alternate on the display.



26. To deactivate the buzzer, press or turn one of the two knobs or open the door (see points 27 and 28).



To select a further timed cooking, turn the temperature knob right or left again.



When cooking has finished, it is possible to select a new function by rotating the function knob.



To stop the active function and switch off the appliance, press the function knob for a few seconds.



Removing the residual water

At the end of steaming, the water can be emptied from the reservoir.



We recommend emptying the reservoir each time you finish using the appliance to avoid scale build-up.

27. Press the function knob for a few seconds. The water drain screen will appear on the display.



28. Stand to the side of the appliance and open the door ajar for a few seconds to allow excess steam to escape.
29. Fully open the door when safe to do so and cautiously remove the food from the oven.
30. Rest the supplied jug (or other suitable container) on the open door.
31. Extract the tube from its seat and immerse its end in the jug or container.

32. Press the function knob to start the drainage of the water into the jug (or container).

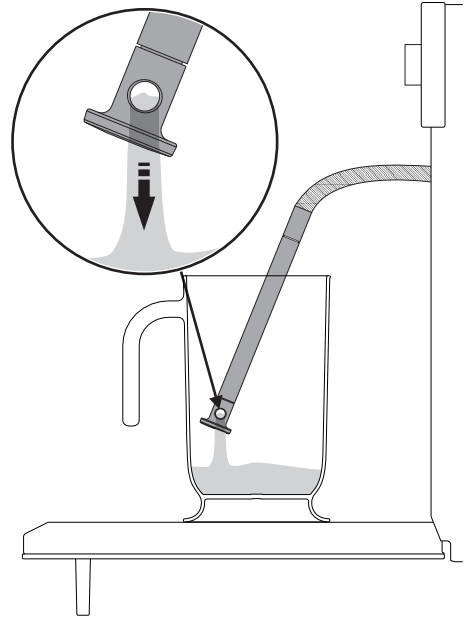

The water drainage function can only be activated with the door open. Always ensure that you have removed the tube from its seat and inserted it into the jug (or container) before pressing the function knob to start the emptying cycle.



Use

When complete, the display will indicate that the residual water removal process is complete.



33. Shake the tube in order to remove any remaining water.

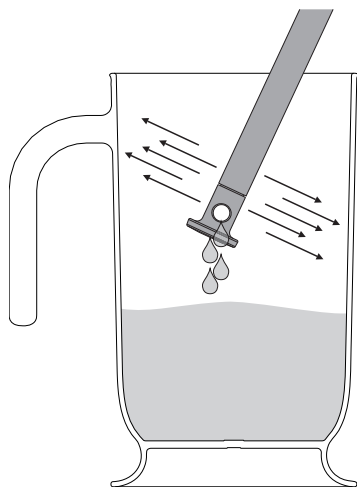

34. Place the tube back into its seat and remove the jug.

35. Inside the oven cavity, remove the cover from the evaporation tray and dry it with the sponge provided.

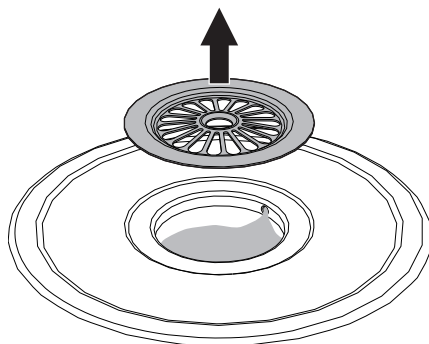

i Note: The evaporation tray cover may be very hot: use appropriate protection.

36. Using a sponge, remove any condensation from the base and walls of the oven, the door glass and drip tray and the front of the appliance.

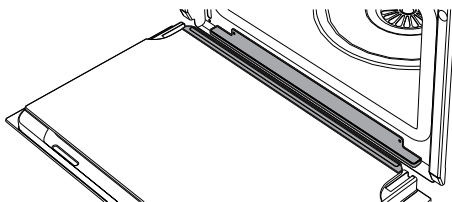

! Take care: the water may be very hot.



Advice for steaming

- **Pasta and rice:** once a temperature of 100°C has been reached the cooking time will be the same as on a cooktop. Put the pasta or rice in a metal tray and cover with about a centimetre of water. For best results when cooking rice, place a lid on the container or cover with aluminium foil. This enables the rice to absorb all the water and can be served directly.
- **Eggs:** can be **boiled, scrambled** or **poached** using the steam function at 100°C. For perfect **boiled** eggs, place them in the perforated tray and cook them for 4-6 minutes for soft-boiled eggs and 8-10 minutes for hard-boiled eggs. For **scrambled eggs**, place the beaten eggs in the metal tray together with milk, butter and the condiments. Cover it with aluminium foil. Every couple of minutes stir the contents with a fork. For **poached eggs** pour boiling water into the metal tray with a drop of vinegar and steam for about 4-5 minutes.
- **Vegetables:** they are perfect when steamed. They maintain their colour, flavour and nutritional value. For dense vegetables such as potatoes, turnips and parsnips, cook at 100°C for the same length of time as you would boil them for on the cooktop. For broccoli and carrots, cook for 6 minutes for a firm consistency or up to 10 minutes for a softer consistency.
- **Fish:** being a naturally delicate food, it is perfect when steamed. For fatty fish such as salmon or trout, cook at 100°C for about 5 minutes. For white fish such as cod and haddock cook at 80°C for about 5 minutes. When cooking different foods at the same time, all the fish should be cooked in the perforated tray placed on the lower shelf of the oven in order to prevent the fish juices from dripping onto other foods.
- **Meat:** casseroles and curry are perfect for steaming. Prepare the casserole as you would for cooking it normally in the oven. Place it in the metal tray, cover with a lid or aluminium foil and according to the cut of meat, cook it between 45 minutes and 3 hours.
- **Thin soups:** steaming helps to enhance the flavour with minimal supervision because the liquids will not overflow. To produce vegetable soup of the right consistency, first steam the vegetables, then add the stock and steam at 100°C. The steam function is also ideal for preparing quantities to store.
- **Soups:** they are simple and quick to prepare. Put the soup in a metal tray, cover with a lid or aluminium foil and steam at 100°C for the same length of time as for microwave cooking. To obtain a creamy texture stir half way through cooking.



- **Reheating foods:** the steam function will not dry the foods and will improve moisture content. A previously prepared home-made meal, covered with aluminium foil requires about 10-12 minutes to cook. Ready meals require about double the amount of time indicated on the packaging.
- **Defrosting:** the steam function can be used to defrost foods. Times may vary, but defrosting using steam takes about half the time compared to leaving covered foods to defrost in a corner of the kitchen.
- **Peeling tomatoes and peppers:** this is very easy to do when using the steam function. Cut a small cross on the skin of the tomato using a knife and steam for about 1 minute. Peppers have tougher skin and it will take up to 4 minutes to soften them sufficiently for peeling.
- **Chocolate:** it can be melted using the steam function. Place the chocolate in the metal tray, cover with aluminium foil and steam for 1 minute. Chocolate is unlikely to burn in the steam oven.
- **Hot towels:** useful for facial care such as a close shave or for use after a meal. They are simple to prepare using the steam function. Dampen a towel with water, roll it up and heat using steam for 1 minute.

Combination cooking functions



Combination cooking functions are ideal for preparing moist cakes and bread and for tender roast meats.

Combination functions list





Steam + fan forced

The combination of the fan, the circulaire heating element and the steam is particularly suitable for preparing roast meats, chicken and baked goods such as bread and leavened sweets.



Steam + fan assisted

The operation of the fan combined with traditional cooking, with the assistance of steam, ensures uniform cooking even with complex recipes. Ideal for roast veal, roast duck and cooking whole fish.

1. Press the function knob to activate the appliance.
2. Turn the function knob to the right or left to set a combination function.
3. Turn the temperature knob to set the combination cooking duration .
4. Press the temperature knob  if you wish to change the default temperature.



5. Turn the temperature knob to the right or left to select the required temperature **°C**.
6. Press the temperature knob if you wish to change the steam percentage **%** (25% by default).
7. Turn the temperature knob to the right or left to select the required percentage of steam **%**.
8. Press the function knob. A request to fill the reservoir with water is shown on the display.



9. Fill the reservoir as described in chapter "Filling the reservoir".
10. Press the function knob to start combination cooking.



Preheating stage

Combination functions are always preceded by a preheating stage, which allows the appliance to heat up to cooking temperature.

The temperature reached flashes to indicate that this stage is in progress.



When the preheating stage is complete, the temperature reached will remain lit steadily and a buzzer will sound to indicate that the food can be placed inside the oven.



This stage is performed without the use of steam.

Then press the function knob to start cooking.





The function in progress can be interrupted at any time by pressing and holding the function knob for a few seconds, or by opening the door.

Steam percentage	Type of food
25%	Breads and cakes
30%	Duck
40%	Beef, veal and lamb
50%	Chicken and chops
70%	Whole fish



Use

Traditional cooking functions

1. Press the function knob to activate the appliance.
2. Turn the function knob to the right or left to select a traditional function.
3. Press the temperature knob  if you wish to change the default temperature.
4. Turn the temperature knob to the right or left to select the required temperature .
5. Press the function knob to start traditional cooking.

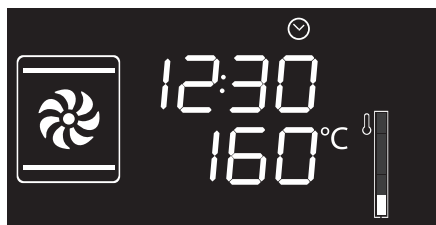

Preheating stage

Traditional functions are always preceded by a preheating stage, which allows the appliance to heat up to cooking temperature.

The temperature reached flashes to indicate that this stage is in progress.



When preheating finishes, the temperature reached remains lit steadily, a buzzer sounds and cooking proceeds automatically.



With traditional cooking, food can be placed in the oven immediately or after preheating, as the user prefers.



Cooking can be interrupted at any time by pressing and holding the function knob for at least 3 seconds, or by opening the door.



Traditional functions list



Fan forced

The combination of the fan and the circular heating element (incorporated in the rear of the oven) allows you to cook different foods on several levels, as long as they need the same temperatures and same type of cooking. Hot air circulation ensures instant and even distribution of heat. It will be possible, for instance, to cook fish, vegetables and biscuits simultaneously (on different levels) without odours and flavours mingling.



Grill

The heat coming from the grill element gives perfect grilling results above all for thin and medium thickness meat and, in combination with the rotisserie (where fitted), gives the food an even browning at the end of cooking. Ideal for grilled cheese and gratinating. This function enables large quantities of food, particularly meat, to be grilled evenly.



ECO (Energy-saving cooking)

This low energy consumption function is particularly suitable for cooking on a single shelf.

Ideal when cooking meat, fish and vegetables. It is not recommended for foods that require proving.

For greater energy savings and to reduce the time required, it is recommended to put foods in the oven cavity without preheating it.



When using the ECO function, avoid opening the door during cooking.



When using the ECO function, cooking times (and pre-heating, if used) are longer.



Convection

As the heat comes from above and below at the same time, this system is particularly suitable for certain types of food. Traditional cooking, also known as static cooking, is suitable for cooking just one dish at a time. Ideal for pies, bread and casseroles. It is also suitable for fatty meat such as duck and goose.



Fan assisted

The operation of the fan, combined with traditional cooking, ensures consistent cooking even with complex recipes. Perfect for roasts.



Fan grill

The air produced by the fan softens the strong heatwave generated by the grill, perfectly grilling even very thick cuts of meat such as steaks, pork chops etc.



Fan forced + baker's function

Fan-assisted cooking is combined with the heat coming from the bottom, and at the same time, allows you to slightly brown food. Ideal for soufflés, quiches and pizza.



Supercook

The combination of fan assisted cooking and traditional cooking allows different foods to be cooked on several levels extremely quickly and efficiently, without odours and flavours mingling. Perfect for large volumes that call for intense cooking.

To obtain a rotisserie effect, set the temperature to maximum. When the appliance reaches maximum temperature, return the temperature to normal. This procedure seals the liquids inside the meat, and reduces shrinkage.





Minute minder

i This function only activates the buzzer, without stopping cooking.

i The minute minder can be activated both during cooking and when the appliance is in standby.

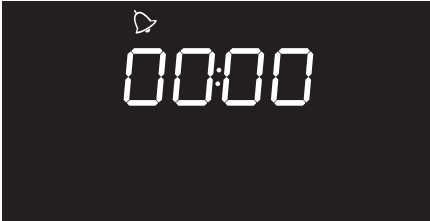
1. Press the temperature knob once (twice if cooking is already in progress). The display shows **00:00** and the indicator light  flashes.



2. Turn the temperature knob to set the duration (from 1 minute to 4 hours). After a few seconds, the indicator light  stops flashing and the countdown starts.
3. Select the required cooking function and wait for the buzzer to sound, indicating that the cooking time is over. The indicator light  flashes.

4. Turn the temperature knob to select another minute minder, or press the temperature knob to stop the buzzer.



You must set the value to zero to remove the minute minder.

Timed cooking



Timed cooking is the function which allows a cooking operation to be started and then ended after a specific length of time set by the user.



Activation of timed cooking cancels any minute minder timer which may previously have been set.

1. After selecting a cooking function and temperature, press the temperature knob three times. The display shows **00:00** and the indicator light  flashes.

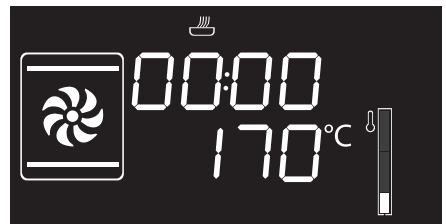



Use

2. Turn the temperature knob right or left to set the cooking duration from 00:01 to 12:59. Keep the knob turned to produce a faster increase or decrease.



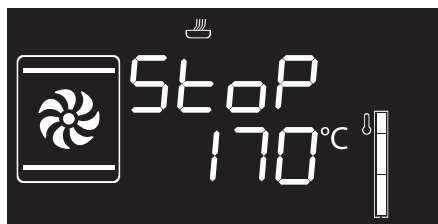

3. A few seconds after the required duration is set, the indicator light  stops flashing and timed cooking starts.
4. At the end of cooking, STOP appears on the display and a buzzer sounds that can be deactivated by pressing the temperature knob.



Press and hold the function knob down to switch off the appliance.

Modifying the data set during timed cooking

During operation, it is possible to modify timed cooking duration:

1. When the indicator light  is steady and cooking is in progress inside the appliance, press the temperature knob twice. The indicator light  starts flashing.
2. Turn the temperature knob right or left to alter the pre-set cooking time.



To select a further timed cooking, turn the temperature knob right or left again.





To extend the cooking time manually, press the temperature knob again. The appliance will resume its normal operation with the previously selected cooking settings.



Programmed cooking

i Programmed cooking is the function which allows cooking to be stopped at an established time depending on the time set by the user, after which the oven will switch off automatically.

1. After selecting a cooking function and temperature, press the temperature knob three times. The display shows

 and the indicator light  flashes.

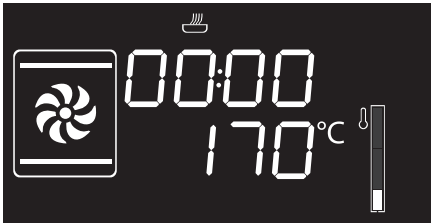

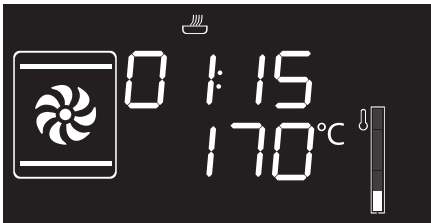

2. Turn the knob right or left to set the cooking duration from 00:01 to 12:59. Keep the knob turned for a fast increase or decrease.



3. Press the temperature knob a fourth time.

The indicator light  flashes. Turn the knob right or left to set the cooking end time.

4. After a few seconds the indicator lights  and  stop flashing. The appliance waits for the set start time.

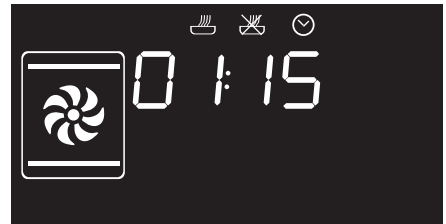



- At the end of cooking, STOP appears on the display and a buzzer sounds that can be deactivated by pressing the temperature knob.









Modifying the data set during programmed cooking



After modifying the cooking duration, the end of cooking time must be re-set.

During operation, it is possible to modify programmed cooking duration:

- When the indicator lights  and  are lit steadily and the appliance is waiting for cooking to start, press the temperature knob twice. The indicator light  starts flashing.
- Turn the temperature knob right or left to alter the pre-set cooking time.
- Press the temperature knob again. The indicator light  switches off and the indicator light  starts flashing. The display shows the cooking end time.
- Turn the temperature knob right or left to delay the cooking end time.
- After a few seconds the indicator lights  and  stop flashing and programmed cooking resumes its operation with the new settings.



To extend the cooking time manually, press the temperature knob again. The appliance will resume its normal operation with the previously selected cooking settings.



Press and hold the function knob down to switch off the appliance.



For safety reasons, it is not possible to set the end of cooking time by itself without setting the cooking duration.



3.5 Cooking advice

General advice

- It is not possible to shorten cooking times by increasing the temperature (the food could be overcooked on the outside and undercooked on the inside).
- Cooking times vary according to the thickness and quality of the food and to consumer taste.
- The first few times you use the appliance, until acquiring sufficient confidence and knowledge of the required cooking times, we suggest setting slightly longer cooking times and testing the food quickly a little before cooking ends. If it is not ready, it is anyway possible to continue to cook it using the remaining cooking time and without having to add more water to the reservoir. If, however, the food is already cooked, it will be possible to immediately stop cooking and drain the residual water from the reservoir.

Advice for cooking meat

- Cooking times vary according to the thickness and quality of the food and to consumer taste.
- Use a meat thermometer when roasting meat, or simply press on the roast with a spoon. If it is hard, it is ready; If not, it needs another few minutes cooking.

Advice for steam cooking

- Cooking times depend on the density of foods and not their quantity. For example, one piece of broccoli will take the same time as 20 florets. Increasing the quantity of a casserole also increases its density, and so the cooking time will also increase.
- Where possible, use a perforated container to allow the steam to circulate around the food from all sides.
- Steam cooking significantly reduces the migration of flavours between different foodstuffs. Nevertheless, always ensure foods like fish cooked in a perforated tray are placed at the bottom of the oven.
- If the steam is likely to change the consistency of the foods being cooked (e.g. casseroles, puddings) always cover them with aluminium foil.



Advice for cooking desserts/pastries and biscuits

- Use dark metal moulds: They help to absorb the heat better.
- The temperature and the cooking time depend on the quality and consistency of the dough.
- To check whether the dessert is cooked right through: At the end of the cooking time, insert a wooden cocktail stick into the highest point of the dessert. If the dough does not stick to the cocktail stick, the dessert is cooked.
- If the dessert collapses when it comes out of the oven, on the next occasion reduce the set temperature by about 10°C, selecting a longer cooking time if necessary.

Advice for defrosting

- Place frozen foods without their packaging in a lidless container on the first shelf of the oven.
- Avoid overlapping the food.
- To defrost meat, use the rack placed on the second level and a tray on the first level. In this way, the liquid from the defrosting food drains away from the food.

To save energy

- Reduce any opening of the door to a minimum to avoid heat dispersal.
- Keep the inside of the appliance clean at all times.



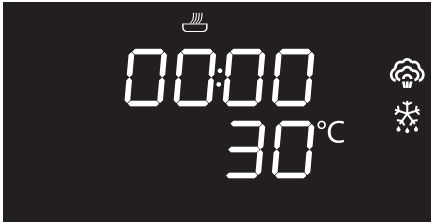

3.6 Special functions

Defrost by time



It is not possible to modify the temperature of the defrost by time function.

1. Place the food to be defrosted inside the oven.
2. Press and turn the function knob to select the defrost by time function marked by the indicator lights  and .
3. Press the function knob to confirm your choice of function.
4. Turn the temperature knob to set the defrost time (from **00:00** to **13:00**).
5. Press the function knob to start defrosting.
6. At the end, the word **STOP** will be displayed.



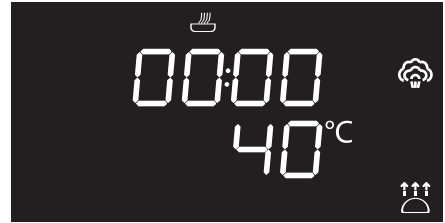

IMPORTANT: always fully defrost foods before cooking.

Proving



When using the proving function the temperature cannot be altered.

1. Place the dough to be proved inside the oven.
2. Press and turn the function knob to select the proving function marked by the indicator lights  and .
3. Press the function knob to confirm your choice of function.
4. Turn the temperature knob to set the proving time (from **00:00** to **13:00**).
5. Press the function knob to start the proving function.
6. At the end, the word **STOP** will be displayed.



Use

Reheat

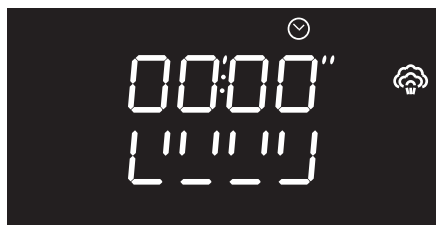

Sabbath



This function allows you to heat previously cooked food which has been kept in the refrigerator.

1. Place the food to be heated inside the oven.
2. Press and turn the function knob to select the heating function.
3. Turn the temperature knob to modify the heating duration.
4. Press the function knob to confirm the parameters and start heating.



This function allows food to be cooked in accordance with the provisions of the Jewish religion day of rest.



This function results in the appliance operating in a particular way:

- Cooking can proceed indefinitely, it is not possible to set any time.
- No preheating will be performed.
- The cooking temperature which can be selected varies between 60-100 °C.
- The oven light remains turned off, any action such as opening the door or manually activating the oven does not turn the lamp on.
- The internal fan remains turned off.
- Knob illumination and audible prompts remain disabled.



After activating the Sabbath function the settings cannot be altered.

Any action on the knobs will produce no effect; only the function knob remains active to allow the appliance to be turned off.

1. Press the function knob to select the Sabbath function.
2. Press the temperature knob.
3. Turn the temperature knob to modify the heating duration.
4. Press the function knob to confirm the parameters and start the Sabbath function.
5. When finished, press and hold the function knob down for at least 3 seconds to turn off the appliance.

Automatic programs

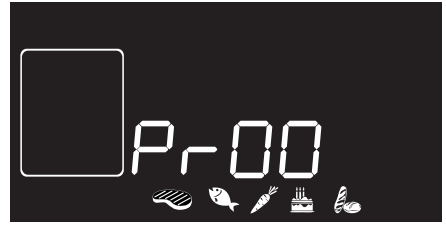

The automatic cooking programs are divided up according to the type of dish to be cooked.

1. Place the food inside the oven.
2. Press the function knob to select the automatic program, marked by **P-00** and the illuminated food symbols .
3. Turn the function knob to select the required program (see Manual water drainage).
4. Press the function knob to start cooking.



Use

Automatic programs table



MEAT (01 - 04)

Pr	Subcategory	Function	Steam %	Weight (g)	Shelf	Temp. (°C)	Time (minutes)
01	Roast pork	+	50	1000	2	180	95
02	Roast veal	+	40	1000	2	170	70
03	Roast chicken	+	50	1000	2	200	40
04	Roast duck	+	30	1000	2	150	105



FISH (05 - 08)

Pr	Subcategory	Function	Steam %	Weight (g)	Shelf	Temp. (°C)	Time (minutes)
05	Cod fillet (piece of approx. 150 g)		100	200	2+1	100	6
06	Salmon fillet (piece of approx. 150 g)		100	200	2+1	100	5
07	Prawns		100	500	2+1	90	5
08	Whole fish	+	70	500	2+1	200	25



VEGETABLES (09 - 12)

Pr	Subcategory	Function	Steam %	Weight (g)	Shelf	Temp. (°C)	Time (minutes)
09	Carrots (rounds of around 3 cm)		100	500	2+1	100	6
10	Potatoes (cut into 4-6 pieces) (diameter 4-5 cm)		100	500	2+1	100	25
11	Cauliflower (in pieces)		100	500	2+1	100	12
12	Asparagus		100	500	2+1	100	6



DESSERTS/PASTRIES (13 - 16)

EN

Pr	Subcategory	Function	Steam %	Weight (g)	Shelf	Temp. (°C)	Time (minutes)
13	Biscuits/muffins		0	600	1	160	18
14	Tart		0	800	1	170	40
15	pudding (300 g in moulds) (400 g in a pudding basin)		100	200	1	100	50
16	Sponge cake Paradise cake	+	25	1000	1	165	35



PASTA (17 - 20)

Pr	Subcategory	Function	Steam %	Weight (g)	Shelf	Temp. (°C)	Time (minutes)
17	White leavened bread	+	25	400	2	180	50
18	Pasta bake/Lasagne		0	2000	1	220	40
19	Quiche		0	1000	1	200	40
20	Basmati rice		100	200	2+1	100	12



Use

Manual water drainage



When complete, the display will indicate that the residual water removal process is complete.



i This function allows you to empty the reservoir manually.

4. Shake the tube in order to remove any remaining water.

1. Rest the supplied jug (or other suitable container) on the open door.
2. Extract the tube from its seat and place the end in the jug (or the container).
3. Press the function knob to activate the residual water drainage into the jug (or container).

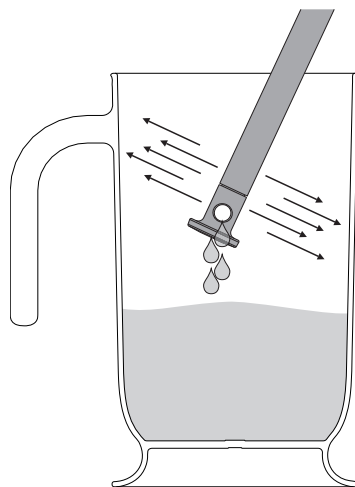

5. Return the tube to its original position, remove the jug/container of solution and close the door.
6. Press the function knob to exit the function.

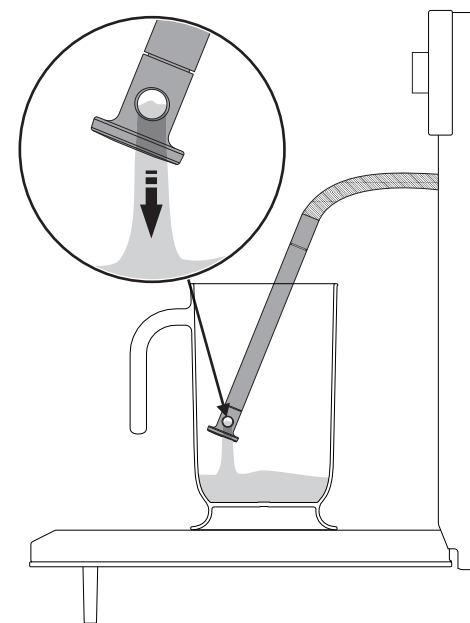

To stop the active function and switch off the appliance, press the function knob for a few seconds.



Manual water fill



i This function allows you to manually fill the reservoir, if you want to perform multiple steam cooking cycles.

1. Fill the jug supplied (or container) with a sufficient amount of water for the cooking that you wish to perform.
2. Open the oven door.
3. Rest the jug or container on the open door.

i Note: the jug or container with the water must have a gross weight lower than 5 kg.

4. Extract the tube from its seat and insert its end in the jug or container until it reaches all the way to the bottom.

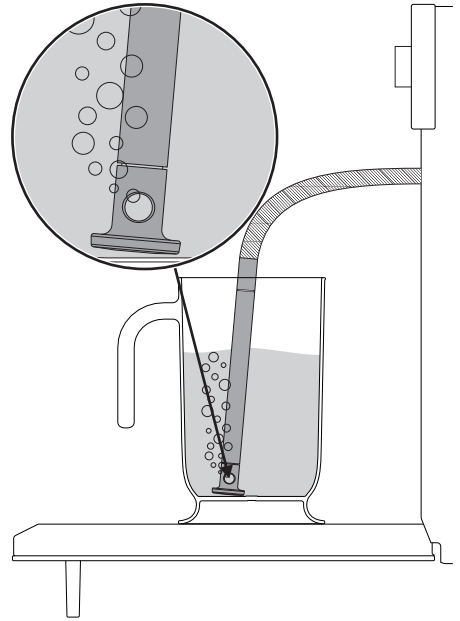

5. Press the function knob to start drawing water into the appliance's reservoir.

i The appliance will take in water until the reservoir is completely full.

 To stop the active function and switch off the appliance, press the function knob for a few seconds.



Use

When complete, the display will indicate that the water fill process is complete.



6. Shake the tube in order to remove any remaining water.

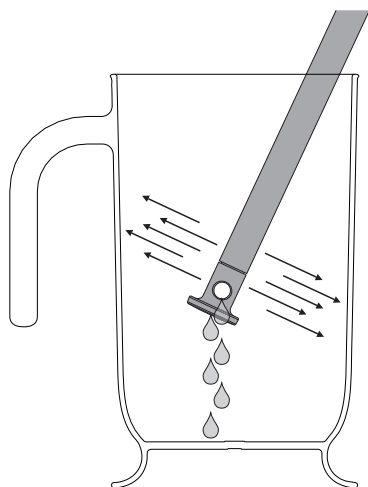

7. Return the tube to its original position, remove the jug/container of solution and close the door.



When the door is closed, an automatic system will automatically draw in any residual water in the tube to avoid drips. A bubbling noise may be heard; this is completely normal.

8. Press the function knob to exit the function.

For the following special functions:

Vapour Clean

Clean reservoir

Manual descaling

see the "Cleaning and maintenance" section in this manual.



3.7 Secondary menu

The appliance has a drop-down secondary menu allowing the user to:

- Activate or deactivate the Child lock.
- Activate or deactivate Showroom mode (which disables all the heating elements so that only the control panel works).
- Activate or deactivate Eco-light mode.
- Set the water hardness value.

With the appliance in Stand-by status

1. Activate the internal light by turning the temperature knob quickly.
2. Press and hold the temperature knob down for at least 5 seconds.
3. Turn the temperature knob to the left or right to change the status of the setting (**ON/OFF**) or to the right to increase the value to set or to the left to decrease it.
4. Press the temperature knob to move to the next mode.

Child lock mode

This mode allows the appliance to lock the controls automatically after one minute of normal operation without any intervention from the user.



During normal operation it is indicated by the indicator light  coming on.

To release the lock temporarily during cooking, hold the temperature knob down for 5 seconds. One minute after the last setting the lock will become active again.



Touching or varying the position of the temperature and function knobs, the display will show

bLoC for two seconds.



It is still possible to turn the appliance off instantaneously by pressing and holding the function knob down for 3 seconds when in child lock mode.



Use

Showroom mode (for exhibitors only)

This mode allows the appliance to deactivate all heating elements, while keeping the control panel active.



To use the appliance normally, set this mode to **OFF**.

i If the mode is active, the indicator light **S** lights up on the display.

Low power (Eco-logic) mode

This mode allows the appliance to limit the power used.

Suitable for simultaneous use with further home appliances.

HI: normal power.

LO: low power.



Activating eco-logic mode means that preheating and cooking times may be extended.



If the mode is active, the indicator light **E** lights up on the display.



Keep Warm mode

This mode allows the appliance to keep cooked food warm (at low temperatures) for around an hour after cooking finishes with a cooking cycle for which a duration has been set (if this is not manually interrupted).



Eco-light mode

For greater energy savings, the light is automatically deactivated one minute from the start of cooking.



To stop the appliance from automatically deactivating the light after one minute, set this mode to **OFF**.



The manual off/on control is always available with both settings by turning the temperature knob to the right.

Water hardness setting mode



The appliance is factory set for water of medium hardness.



This mode allows you to set the water hardness value in order to optimise the descaling process.



It is possible to modify the water hardness setting from the minimum value (one bar)...



... Up to the maximum value (five bars).



Request information on the hardness of your water from your local water board.



If your mains water supply is too hard, we recommend using a water softener.



4 Cleaning and maintenance

4.1 Instructions



Improper use

Risk of damage to surfaces

- Do not use steam jets to clean the appliance.
- Do not use cleaning products containing chlorine, ammonia or bleach on parts made of steel or that have metallic surface finishes (e.g. anodizing, nickel- or chromium-plating).
- Do not use abrasive or corrosive detergents (e.g. scouring powders, stain removers and metallic sponges) on glass parts.
- Do not use rough or abrasive materials or sharp metal scrapers.



Improper use

Risk of damage to the appliance

- Do not remove the seal on the face of the oven.

Ordinary daily cleaning

Always and only use specific products that do not contain abrasives or chlorine-based acids.

Pour the product onto a damp cloth and wipe the surface, rinse thoroughly and dry with a soft cloth or a microfibre cloth.

Food stains or residues

Do not use steel sponges and sharp scrapers as they will damage the surface.

Use normal, non-abrasive products and a wooden or plastic tool, if necessary. Rinse thoroughly and dry with a soft cloth or a microfibre cloth.

Do not allow residues of sugary foods (such as jam) to set inside the oven. If left to set for too long, they might damage the enamel lining of the oven.

4.2 Cleaning the surfaces

To keep the surfaces in good condition, they should be cleaned regularly after use. Let them cool first.



4.3 Cleaning the door

Removing the door

For easier cleaning it is recommended to remove the door and place it on a tea towel.

To remove the door proceed as follows:

1. Open the door completely and insert two pins into the holes on the hinges indicated in the figure.

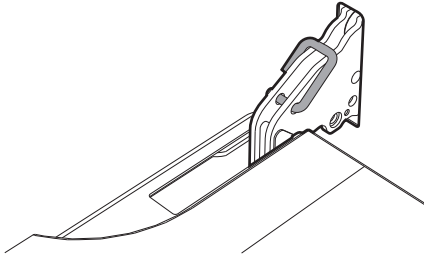

2. Grasp the door on both sides with both hands, lift it forming an angle of around 30° and remove it.

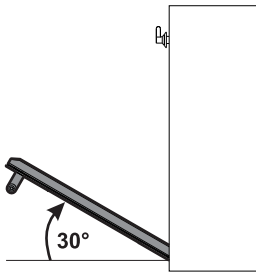

3. To reassemble the door, put the hinges in the relevant slots in the oven, making sure that grooved sections **A** are resting completely in the slots. Lower the door and once it is in place remove the pins from the holes in the hinges.

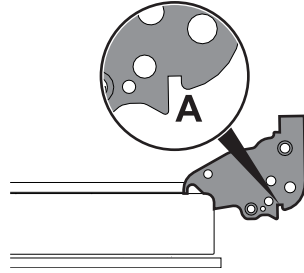

Cleaning the door glazing

The glass in the door should always be kept thoroughly clean. Use absorbent kitchen roll. In case of stubborn dirt, wash with a damp sponge and an ordinary detergent.



We recommend the use of cleaning products distributed by the manufacturer.



Cleaning and maintenance

Removing the internal glass panes

For easier cleaning the internal glass panes of the door can be removed.

1. Open the door.
2. Remove the internal glass pane by pulling the rear part gently upwards, following the movement indicated by the arrows (1).
3. Then, pull the front part upwards (2). This way, the 4 pins attached to the glass detach from their housings in the oven door.

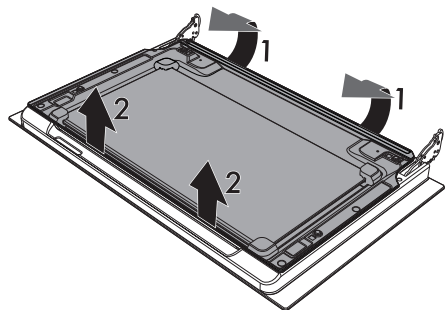

4. Raise the intermediate glass unit upwards.

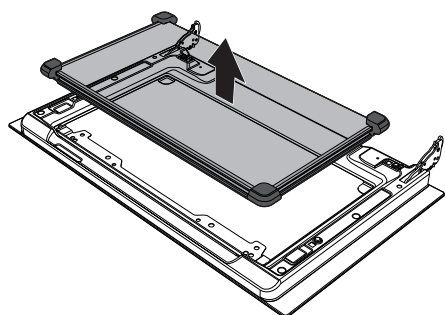

5. Clean the external glass pane and the panes removed previously. Use absorbent kitchen roll. In case of stubborn dirt, wash with a damp sponge and neutral detergent.

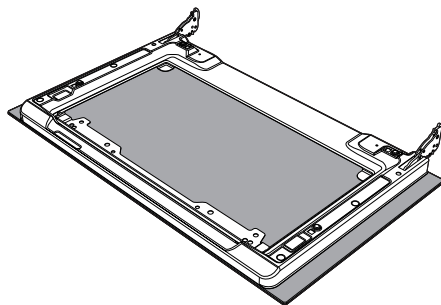

6. Reposition the intermediate glass unit.

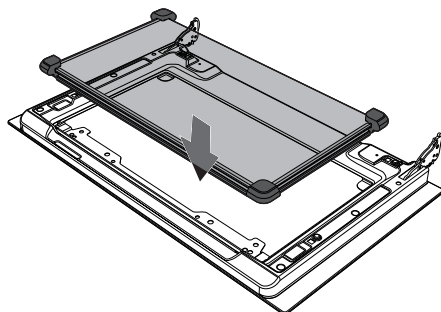



7. The rubber strips **A**, **B** and **C** of the intermediate glass unit must face the outer glass.

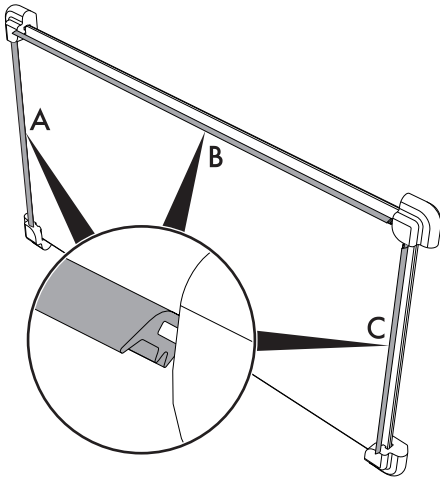

8. Centre and insert the 4 pins into their housings in the oven door by applying slight pressure.

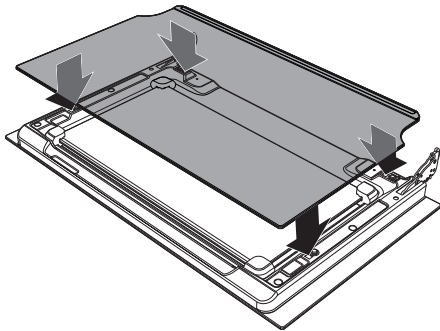

4.4 Cleaning the inside of the oven

For the best oven upkeep, clean it regularly after having allowed it to cool.

Take out all removable parts.

Clean the oven racks with warm water and non-abrasive detergents. Carefully rinse and dry damp parts.

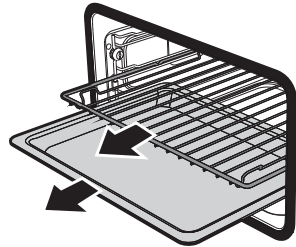

The oven should be operated at the maximum temperature for about 15-20 minutes after the use of specific products, to burn off the residues left inside the oven.



For easier cleaning, remove the door.



Cleaning and maintenance

Removing rack/tray support frames

Removing the guide frames enables the sides to be cleaned more easily.

To remove the guide frames:

1. Unscrew the frame fastening pins:

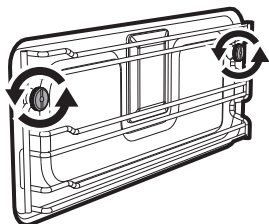

2. Pull the frame towards the inside of the oven to free it from the fastening pins.

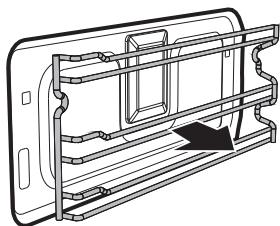

3. When cleaning is complete, repeat the above procedures to put the guide frames back in.

Vapor Clean



Vapor Clean is an assisted cleaning procedure which facilitates the removal of dirt. Thanks to this process, it is possible to clean the inside of the oven very easily. The dirt residues are softened by the heat and water vapour for easier removal afterwards.



Improper use
Risk of damage to surfaces

- Remove any food residues or large spills from previous cooking operations from the inside of the oven.
- Carry out assisted oven cleaning operations only when the oven is cold.

Preliminary operations

Before starting the Vapor Clean cycle:

- Completely remove all accessories from inside the oven.
- Pour approx. 40 cc of water onto the floor of the oven. Make sure it does not overflow out of the cavity.

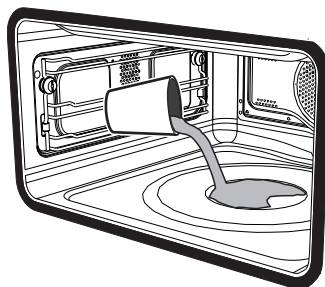



- Spray a water and washing up liquid solution inside the oven using a spray nozzle. Direct the spray against the side walls, upwards, downwards and towards the deflector.

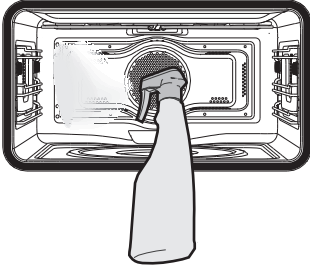

- Close the door.



We recommend spraying approx. 20 times at the most.

Vapor Clean cycle setting

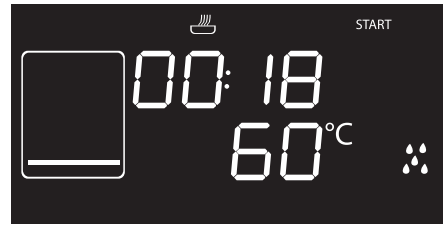

i

If the internal temperature is greater than that required for the Vapor clean cycle, the cycle will be stopped immediately and the message **STOP** will appear on the display. Let the appliance cool down before activating the assisted cleaning cycle.

1. Press the function knob to activate the appliance.
2. Turn the function knob to the right or left to select the Vapor Clean function .
3. The duration and temperature of the cleaning cycle will appear on the display.
4. Press the temperature knob to start the Vapor Clean cleaning cycle.
5. A buzzer will indicate the end of the Vapor Clean cycle.

i

The temperature and time parameters cannot be modified by the user.



Cleaning and maintenance

End of the Vapor Clean cycle

1. Open the door and wipe away the less stubborn dirt with a microfibre cloth.
2. Use a non-scratch sponge with brass filaments on hard to remove deposits.
3. In case of grease residues use specific oven cleaning products.
4. Remove the water left inside the oven.
5. For improved hygiene and to avoid food being affected by any unpleasant odours, we recommend that the oven is dried using a fan assisted function at 160°C for approximately 10 minutes.



We recommend wearing rubber gloves for these operations.



We recommend removing the door in order to make the manual cleaning of the parts that are difficult to reach easier.

CLEAN: Cleaning the reservoir



To guarantee optimum performance of your appliance, we recommend cleaning the reservoir every 2-3 months.

1. Press and turn the function knob to select the **CLEAN** function.



2. Press the function knob to confirm your choice of function. The display will show a request to fill the reservoir.



3. Fill the jug (or container) provided with a solution of water and citric acid.



We recommend mixing 30 g of citric acid with 1.5 litres of water.

Cleaning and maintenance



EN

4. Open the oven door.
5. Rest the jug or container on the open door.

i Note: the jug or container with the mixture must have a gross weight lower than 5 kg.

6. Extract the tube from its seat and immerse its end in the jug (or container) until it reaches all the way to the bottom.

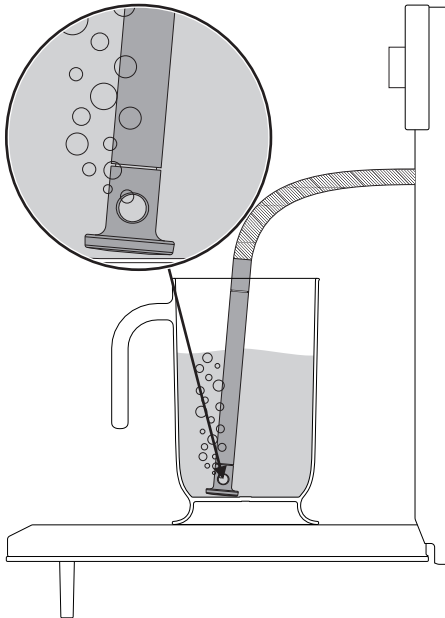

7. Press the function knob to start drawing the solution into the appliance's reservoir.

i The appliance will automatically draw sufficient solution to fill the reservoir.

8. When the appliance has finished taking in water, shake the tube to remove any residual water.

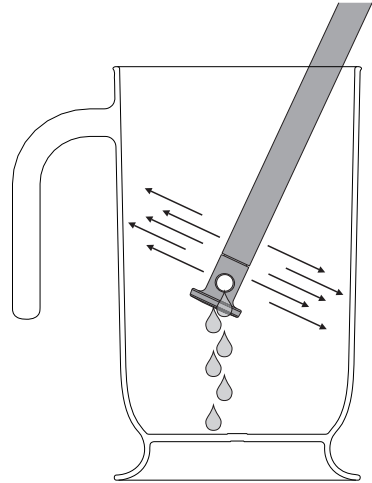

9. Return the tube to its original position, remove the jug/container of solution and close the door.

i When the door is closed, an automatic system will automatically draw in any residual solution in the tube to avoid drips.

10. Press the function knob to start the reservoir cleaning process. The display will show the time left until the end of the cleaning cycle.



Cleaning and maintenance

When the cleaning process is complete, a buzzer will sound and the display will show the solution draining screen.



11. Rest the supplied jug (or other suitable container) on the open door.
12. Extract the tube from its seat and place the end in the jug (or the container).
13. Press the function knob to start the drainage of the solution into the jug (or container).

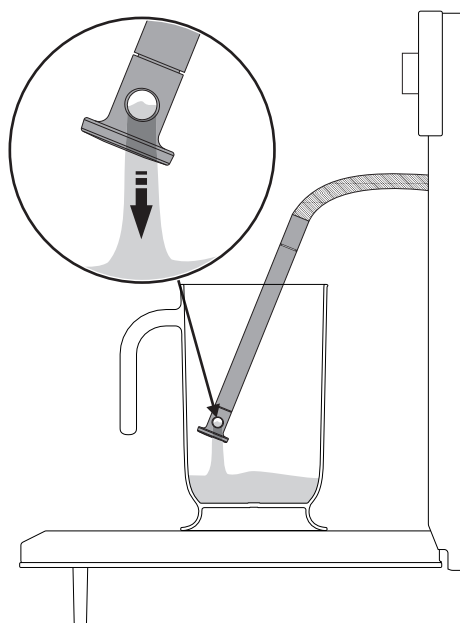

14. When this has finished, shake the tube to remove any solution residues.

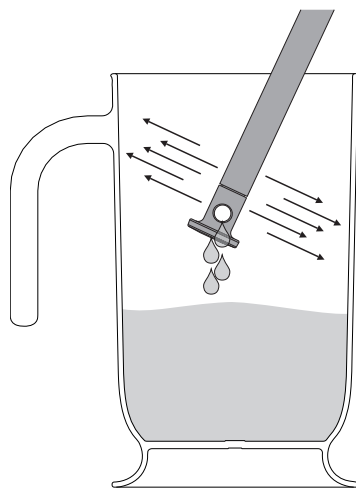

15. Return the tube to its original position, remove the jug/container of solution and close the door.



After cleaning the reservoir with the water and citric acid solution, perform at least one more **CLEAN** cycle with clean water in order to rinse any impurities from the reservoir.



Descaling



The presence of scale due to lack of descaling can compromise correct operation of the appliance in the long term.

The following message will periodically appear on the appliance display, notifying you that you need to descale the evaporation tray on the base of the oven.



1. Open the door completely.
2. Pour approximately 250 ml of white vinegar into the evaporation tray, thus also covering part of the base of the oven.

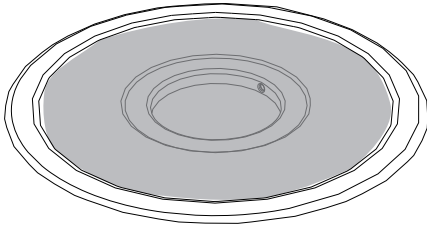

3. Press the function knob to start the descaling function.



4. At the end of the descaling process, remove the vinegar from the base of the oven with the supplied sponge.
5. Use a dish sponge on softened encrustations in order to remove the largest possible quantity of scale.
6. When you have finished cleaning, close the door again.



We recommend performing descaling every time this is indicated on the display in order to keep the boiler in perfect operating condition.



If you wish to skip the descaling process, hold down the function knob for a few seconds.



Note: The descaling process can be skipped three consecutive times. After this, the appliance will not allow you to run any other function until the descaling process is performed.



Cleaning and maintenance

Manual descaling

When you wish to perform descaling in advance, you can run the function manually:

7. Press and turn the function knob to select the descaling **DEC** function.

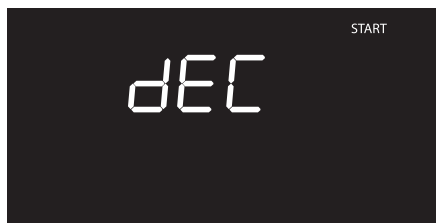

8. Proceed with the procedure described in the "Removing rack/tray support frames" chapter, beginning at point 1.

What to do if...

The display is completely off:

- Check the mains power supply.
- Check that any circuit breakers upline of the appliance supply line are in the "ON" position.

The appliance does not heat up:

- Check whether it has been set in "showroom" mode (for further details see "Secondary menu").

The controls do not respond:

- Check whether "child lock" mode has been set (for further details see "Secondary menu").



If the problem has not been resolved or in the case of other types of fault, contact your local technical support centre.



If other ERRx error messages are indicated:
Note down the error message, function and set temperature and contact your local technical support centre.



4.5 Extraordinary maintenance



Live parts
Danger of electrocution

- Unplug the appliance.

Replacing the internal light bulb

1. Completely remove all accessories from inside the oven.
2. Remove the rack/tray support frames.
3. Remove the bulb cover using a tool (e.g. a screwdriver).



Pay attention not to scratch the oven cavity enamel.

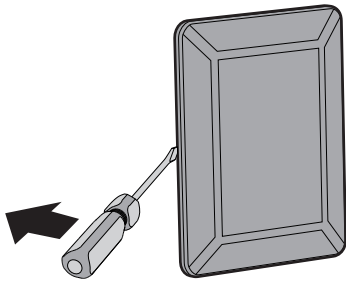

4. Slide out and remove the light bulb.

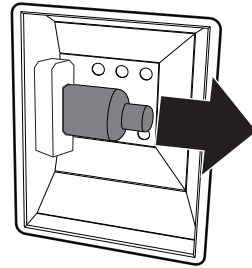

Do not touch the halogen light bulb directly with your fingers, but wrap it in insulating material.

5. Replace the light bulb with one of the same type (40W).
6. Refit the cover. Ensure the moulded part of the glass (**A**) is facing the door.

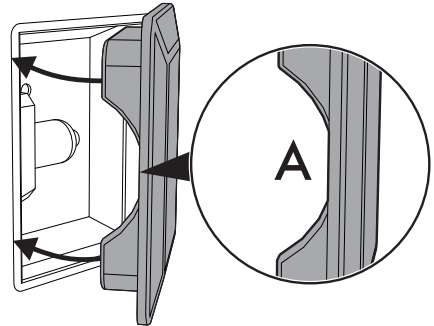

7. Press the cover completely down so that it attaches perfectly to the bulb support.



Installation

5 Installation

5.1 Electrical connection



Power voltage
Danger of electrocution

- Have the electrical connection performed by authorised technical personnel.
- The appliance must be connected to earth in compliance with electrical system safety standards.
- Disconnect the mains power supply.

General information

Check the grid characteristics against the data indicated on the plate.

The identification plate bearing the technical data, serial number and brand name is visibly positioned on the appliance.

Do not remove this plate for any reason.

The appliance operates at 220-240 V~.

Use a three-core cable (3 x 1.5 mm² internal conductors).

Make the earth connection using a wire that is 20 mm longer than the other wires.

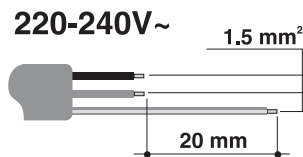

Fixed connection

Fit the power line with an omnipolar circuit breaker in compliance with installation regulations.

The omnipolar circuit breaker should be located near the appliance and in an easily reachable position, according to applicable electrical codes.

Connection with plug and socket

Make sure that the plug and socket are of the same type.

Avoid using adapters and shunts as these could cause overheating and a risk of burns.

5.2 Cable replacement



Power voltage
Danger of electrocution

- Disconnect the mains power supply.

1. Unscrew the rear casing screws and remove the casing to access the terminal board.
2. Replace the cable.
3. Make sure that the cables (for the oven or any hob) follow the best route in order to avoid any contact with the appliance.



5.3 Positioning



**Heavy appliance
Crushing hazard**

- Position the appliance into the cabinet cut-out with the help of a second person.



**Pressure on the open door
Risk of damage to the appliance**

- Never use the oven door to lever the appliance into place when fitting.
- Avoid exerting too much pressure on the oven door when open.



**Heat production during appliance
operation
Risk of fire**

- Check that the carcass material is heat resistant.
- Check that the carcass has the required openings.
- Do not install the appliance in a recess which can be closed with a door, or in a cupboard.

Position of the power cable

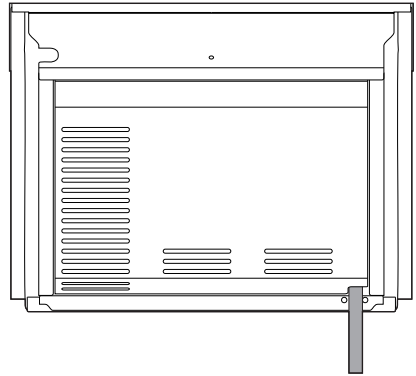

(rear view)

Front panel seal

Glue the supplied seal to the rear part of the front panel to avoid water or other liquids from leaking in.

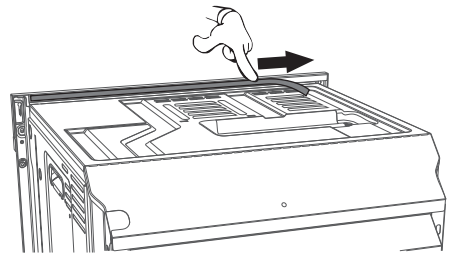



Installation

Fastening bushings

Remove the bushing covers on the front of the oven.

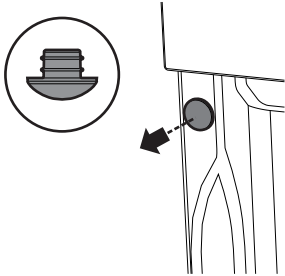

Mount the appliance into the recess.

Secure the appliance to the carcass using the screws.

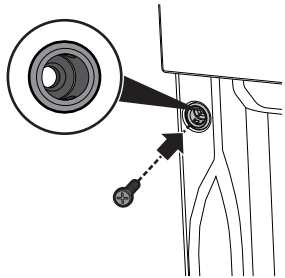

Cover the bushings with the previously removed covers.

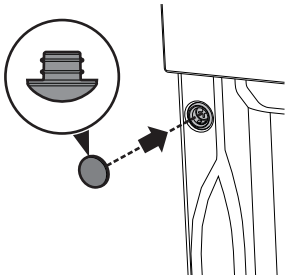

Appliance overall dimensions (mm)

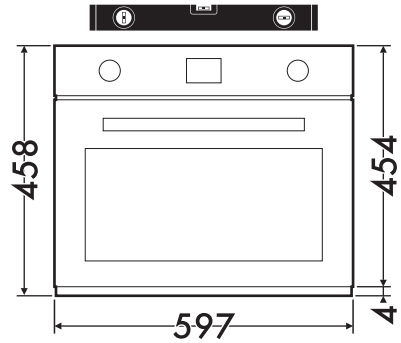

(front view)

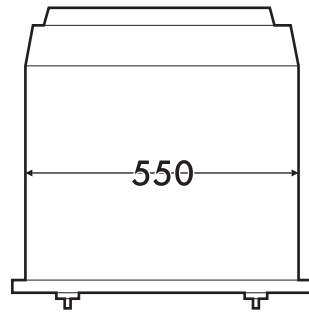

(top view)



Mounting under worktops (mm)

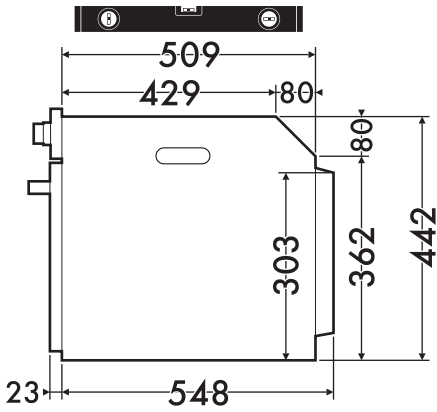

(side view)

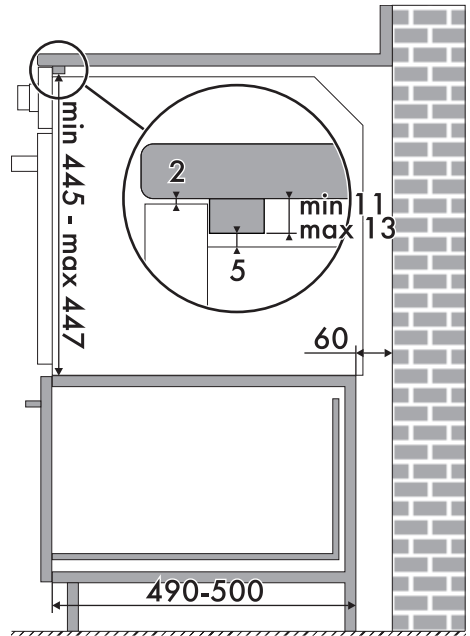
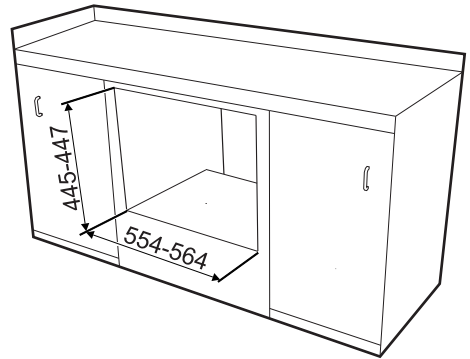
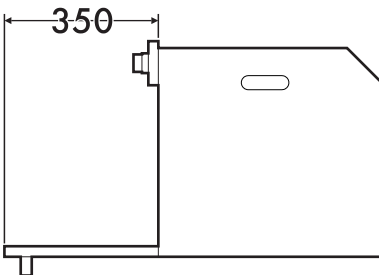
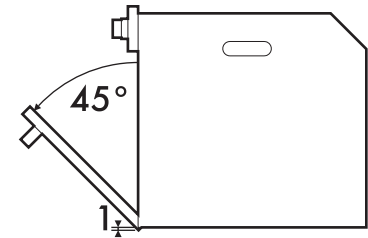

 Make sure that the carcass rear/bottom section has an opening of approx. 60 mm.



Installation

Mounting into a column (mm)

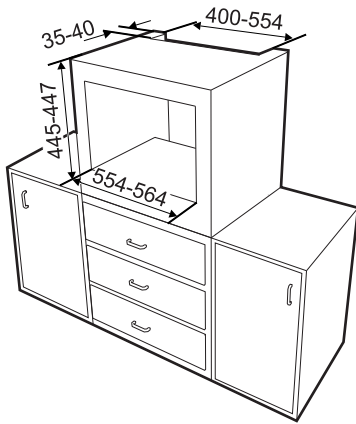

Make sure that the carcass top/
rear section has an opening
approx. 35-40 mm deep.

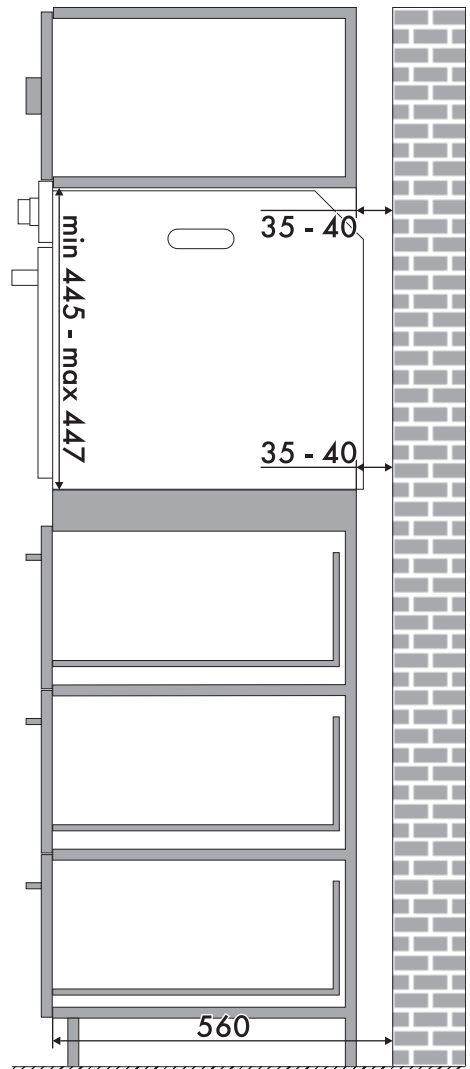



5.4 Instructions for the installer

- The plug must be accessible after installation. Do not bend or trap the power cable.
- The appliance must be installed according to the installation diagrams.
- If the appliance does not work correctly after having carried out all the checks, contact your local Authorised Service Centre.
- Once the appliance has been installed, please explain to the user how to use it correctly.



914777466/B