

PRECAUTIONS	21
General safety instructions	21
Installation	24
Appliance purpose	25
This user manual	25
Manufacturer's liability	25
Identification plate	25
Disposal	25
To save energy	26
How to read the user manual	26
DESCRIPTION	26
General description	26
Control panel	28
USE	28
Preliminary operations	28

Basic functions	28
Using the hob	28
CLEANING AND MAINTENANCE	33
Cleaning the glass ceramic hob	33
What to do if...	33
INSTALLATION	34
Electrical connection	34
Section cut from the countertop	35
Mounting	36
Fixing to the built-in cabinet	37
Fixing brackets	37
Testing	37
Instructions for the installer	37

We advise you to read this manual carefully, which contains all the instructions for maintaining the appliance's aesthetic and functional qualities. For further information on the product: www.smeg.com

PRECAUTIONS

General safety instructions

Risk of personal injury

- During use the appliance and its accessible parts become very hot. Keep children well away from the appliance.
- The appliance becomes very hot during use. Take care never to touch the heating elements.
- Protect your hands by using oven gloves when handling hot pans.
- Never try to put out a fire or flames with water: turn off the appliance and smother the flames with a fire blanket or other appropriate cover.
- This appliance may only be used by children aged 8 years and over, and by people of reduced physical, sensory or mental capacity, or lacking in experience in the use of electrical appliances, provided that they are supervised or have been given instructions on the safe use of the appliance and of the hazards associated with it.
- Children must not play with the appliance.
- Keep children below the age of 8 away from the appliance unless they are constantly supervised.
- Keep children under the age of 8 away from the appliance when it is in use.
- Cleaning and maintenance must not be carried out by unsupervised children.
- Be aware of how rapidly the

cooking zones heat up. Do not place empty pans on the heat. Danger of overheating.

- After use the cooking zones remain hot for a certain period of time after they have been turned off. Do not touch the hob surfaces.
- The cooking process must always be kept under control. A short cooking process must be continuously monitored.
- **WARNING:** Leaving food that contains fat and/ or oil unattended when cooking can be dangerous and can cause a fire. **DO NOT** attempt to extinguish a fire with water. Turn off the appliance and smother the flames, for example with a lid or a blanket.
- Do not use the Booster and/ or the Double Booster functions (if present) to heat fats or oils. Fire hazard.
- Do not place metal objects, such as dishes or cutlery, on the surface of the hob during cooking as they may overheat.
- Do not cook foods in closed tins or containers or plastic containers.
- Do not insert pointed metal objects (cutlery or utensils) into the slots in the appliance.
- Do not use or store flammable materials near the appliance.
- Do not pour water directly onto very hot trays.
- If you need to move food or at the end of cooking, open the door 5 cm for a few seconds, let the steam come out, then open it fully.
- Switch off the appliance immediately after use.
- Do not pull the cable to unplug the appliance (if present).
- **DO NOT USE OR STORE FLAMMABLE MATERIALS IN THE STORAGE COMPARTMENT (IF AVAILABLE) OR NEAR THE APPLIANCE.**
- **DO NOT USE AEROSOLS IN THE VICINITY OF THIS APPLIANCE WHILST IT IS IN USE.**
- **DO NOT MODIFY THIS APPLIANCE.**
- Always wear personal protective equipment (PPE) before carrying out any work on the appliance (installation, maintenance, positioning or moving).
- Do not clean the appliance if it is still hot or in operation.
- Before performing any work on the appliance, switch off the power supply.
- **WARNING:** Make sure that the appliance has been switched off and disconnected from the mains power supply or that the mains power has been switched off before replacing the interior lighting bulbs.

- The bulbs used in this appliance are specific for household appliances; do not use them for home lighting.
- Do not try to repair the appliance yourself or without the assistance of a qualified technician.
- Installation and servicing should be carried out by qualified personnel in accordance with current standards.
- If the power cable becomes damaged, contact technical support immediately to arrange for it to be replaced in order to avoid possible hazards.
- If cracks or fissures form, or if the glass ceramic cooking surface breaks, turn off the appliance immediately. Disconnect the power supply and call Technical Support.
- Do not touch or clean the hob surface during operation or when the residual heat indicator lights are still on.
- Activate the controls lock when you have children or pets that could reach the hob.
- Supervise children carefully as they cannot readily see the indication of residual heat. After use the cooking zones remain hot for a certain period of time even if they have been turned off. Keep children away from the cooking zones.
- The appliance is not intended

to operate with external timers or remote-control systems.

- **WARNING:** Only use a protective shield designed by the manufacturer of the cooking appliance. The use of inadequate protective shields can lead to accidents.

Risk of damaging the appliance

- Do not use harsh or abrasive detergents or sharp metal scrapers to clean the glass door of the oven since they may scratch the surface and cause the glass to shatter.
- Use wooden or plastic utensils.
- Do not use steam jets to clean the appliance.
- Do not use the appliance as a support surface.
- Do not obstruct ventilation openings and heat dispersal slots.
- Do not sit on the appliance.
- Never leave the appliance unattended during cooking operations that could lead to oils and fats overheating and catching fire. Be very careful
- Risk of fire: Do not store objects on the cooking surfaces.
- Do not spray any product near the appliance.
- **DO NOT FOR ANY REASON USE THE APPLIANCE AS A SPACE HEATER.**
- Do not use plastic kitchenware or containers for cooking.

- Cooking vessels or griddle plates should be placed inside the perimeter of the hob.
- All pans must have smooth, flat bottoms.
- If any liquid does boil over or spill, remove the excess from the hob.
- Take care not to spill acid substances such as lemon juice or vinegar on the hob.
- Do not spill sugar or sweet mixtures on the hob during cooking.
- Do not place materials or substances that could melt or catch fire (paper, plastic or aluminium foil) on the appliance while it is in use.
- Do not use steam jets to clean the appliance.
- Place the cookware directly on the glass ceramic surface.
- Do not put empty pans or frying pans on switched on cooking zones.
- Do not use rough or abrasive materials or sharp metal scrapers.
- Do not use cleaning products containing chlorine, ammonia or bleach on parts made of steel or that have metallic surface finishes (e.g. anodizing, nickel- or chromium-plating).
- Do not use abrasive or corrosive detergents (e.g. scouring powders, stain removers and metallic

- sponges) on glass parts.
- The glass ceramic surface is highly resistant to impacts. However, avoid hard, solid objects falling on the cooking surface as they may cause it to break.
- Keep sensor buttons clean at all times and do not place any object on them.

Installation

- **THIS APPLIANCE MUST NOT BE INSTALLED IN A BOAT OR CARAVAN.**
- This appliance must not be installed on a pedestal.
- Always use any necessary/required personal protective equipment (PPE) before performing any work on the appliance (installation, maintenance, positioning or movement).
- Check that the cabinet has the required slots.
- Check that the cabinet material is heat resistant.
- Installation and servicing should be carried out by qualified personnel in accordance with current standards.
- Have the electrical connection performed by authorised technical personnel.
- The appliance must be connected to earth in compliance with electrical system safety standards.
- Use cables withstanding a

- temperature of at least 90 °C.
- The tightening torque of the screws of the terminal supply wires must be 1.5 - 2 Nm.
- Be careful when connecting additional electrical appliances. Connection cables must not come into contact with hot cooking zones.
- The power cable must only be installed or replaced by a qualified technician.
- Allow the appliance to be disconnected after installation, via an accessible plug or a switch in the case of a fixed connection.
- Fit the power line with an all-pole circuit breaker with a contact separation distance sufficient to provide complete disconnection in category III overvoltage conditions, pursuant to installation regulations.
- This appliance can be used up to a maximum altitude of 2,000 metres above sea level.

Appliance purpose

This appliance is intended for cooking food in the home environment. Every other use is considered inappropriate. It cannot be used:

- in employee kitchens, shops, offices and other working environments.
- in farms/farmhouses.
- by guests in hotels, motels and

residential environments.

- In bed and breakfast accommodation.

This user manual

- This user manual is an integral part of the appliance and must therefore be kept in its entirety and within the user's reach for the whole working life of the appliance.
- Read this user manual carefully before using the appliance.
- The explanations in this manual include images, which describe all that regularly appears on the display. However, it should be kept in mind that the appliance may be equipped with an updated version of the system, and as such, all that appears on the display may differ from those in the manual.

Manufacturer's liability

The manufacturer declines all liability for damage to persons or property caused by:

- use of the appliance other than that specified;
- failure to comply with the instructions in the user manual;
- tampering with any part of the appliance;
- use of non-original spare parts.

Identification plate

The identification plate bears the technical data, serial number and brand name of the appliance. Do not remove the identification plate for any reason.

Disposal



This appliance conforms to the WEEE European directive (2012/19/EU) and must be disposed of separately from other waste at the end of its service life.

The appliance does not contain substances in quantities sufficient to be considered hazardous to health and the environment, in accordance with current European directives.



Power voltage
Danger of electrocution

- Disconnect the mains power supply.
- Unplug the appliance.

To dispose of the appliance:

- Cut the power cable and remove it.

- Deliver the appliance to the appropriate recycling centre for electrical and electronic equipment waste, or return it to the retailer when purchasing an equivalent product, on a one for one basis.

Our appliances are packaged in non-polluting and recyclable materials.

- Deliver the packing materials to the appropriate recycling centre.



**Plastic packaging
Danger of suffocation**

- Do not leave the packaging or any part of it unattended.
- Do not let children play with the plastic bags.

To save energy

- The diameter of the base of the pan must not extend beyond the lines printed on the glass ceramic surface.
- Pans must not be placed outside the perimeter of the hob or on the display.
- When buying a pan, check whether the diameter indicated is that of the base or the top of the pan, as the top is almost always larger than the base.

- When preparing dishes with long cooking times, you can save time and energy by using a pressure cooker, which also helps to retain vitamins contained in the food.
- Make sure that the pressure cooker contains enough liquid as, if there is not enough and it overheats, this may cause damage to both the pressure cooker and the cooking zone.
- If possible, always cover pans with a suitable lid.
- Choose a pan suitable for the quantity of food to be cooked. A large, half-empty saucepan leads to a waste of energy.



Under certain circumstances, if the hob and the oven are used at the same time, the maximum power limit of the electrical system might be exceeded.

How to read the user manual

This user manual uses the following reading conventions:



Warning/ Caution



Information/Advice

DESCRIPTION

General description

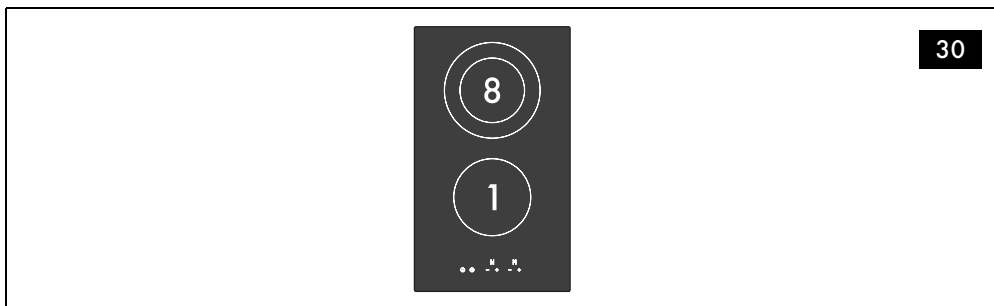

60

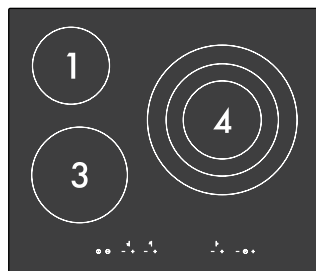
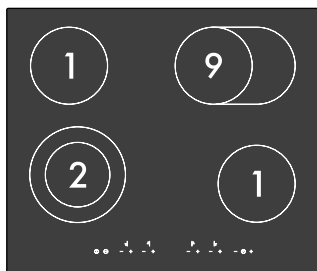
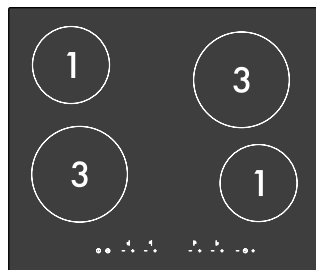
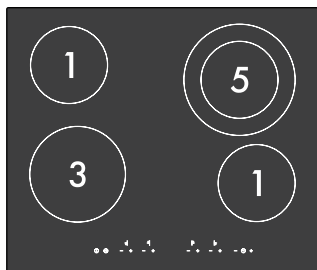

77

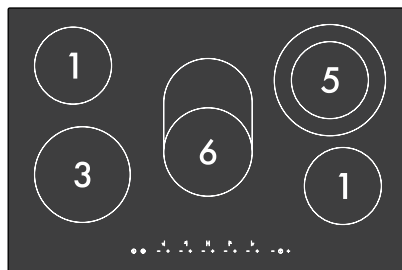
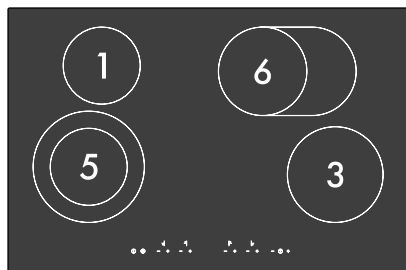

90

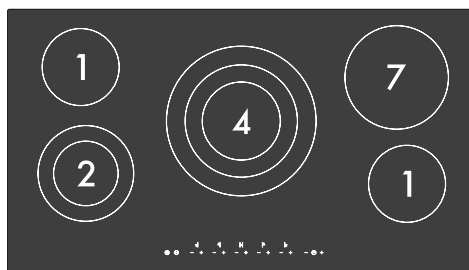

Zone	Outer diameter (mm)	Maximum power draw (W)*	Inside diameter (mm)	Maximum power draw (W)*	Middle diameter (mm)	Maximum power draw (W)*
1	148	1200	-	-	-	-
2	184	2000	124	800	-	-
3	184	1800	-	-	-	-
4	288	2700	150	1950	216	1050

Zone	Outer diameter (mm)	Maximum power draw (W)*	Inside diameter (mm)	Maximum power draw (W)*	Middle diameter (mm)	Maximum power draw (W)*
5	214	2200	148	1000	-	-
6	oval plate	2200	170	1400	-	-
7	199	2000	-	-	-	-
8	184	1700	124	700	-	-
9	oval plate	2000	148	1100	-	-

*Power levels are approximate and may vary according to the settings made and the mains voltage.

Control panel

Symbols



ON/OFF button

Turns the hob on or off.



Control lock button

Activates or deactivates the controls lock if pressed for 3 seconds.



Increase button

Increases the power level or cooking time.



Decrease button

Reduces the power level or cooking time.



Timer button

Activates the timer for the automatic shutdown/minute minder function.

Cooking zones



Front left



Rear left



Central



Rear right



Front right



Central right



Front (30 cm model only)



Rear (30 cm model only)

USE

Preliminary operations



See General safety instructions.

- Remove any protective film from the outside or inside of the appliance, including any accessories (if present).
- Remove any labels (apart from the technical data plate).

Basic functions

First power connection

When connected to the power supply for the first time, or after power has been switched back on after a power failure, an automatic check is carried out that control turns on the indicator lights and the displays for a few seconds. Afterwards, the appliance can be

used normally.

Switching on and off

To switch on the hob, hold down the **ON/OFF**









key for 1 second.

If no cooking zone is activated within 5 seconds of switching on, the hob switches off automatically.



Using the hob

Switching on a single cooking zone

- After switching on the hob, use the Increase button  to activate the required cooking zone. The symbol  appears on the display.

- Press the Increase button again .
The  or  symbol appears on the display to indicate that the cooking zone is on at maximum power.
- Press the Increase  or Decrease  buttons to increase or decrease the power level.







When the cooking zone is off () , it cannot be activated by pressing the Decrease  button.





If the Increase button is pressed when the cooking zone is on maximum power, the cooking zone switches off.

Switching on the double / triple cooking zone

- After setting the maximum power  or , press the Increase  buttons. An illuminated dot appears on the display next to the power setting to indicate that the internal cooking zone  or  is on.

For a triple cooking zone (if present)

- Press the Increase  button again to completely activate the cooking zone. The illuminated dot flashes on the display next to the power setting to indicate that the entire cooking zone  or  is on.

To modify the power level (both zones)

- Use the Increase  and Decrease  buttons to increase or decrease the power level.







If the Increase button is pressed when the cooking zone is on maximum power, the cooking zone switches off.

Melting function



This function can be used to melt food such as butter and chocolate.

To activate the Melting function, first turn on the hob, then:





- After having set the power to , press the Increase button .  appears on the display.
- Press the increase button again .  appears on the display.

Residual heat

If the cooking zone is still hot after being switched off, the  symbol will be displayed on the display.

Accelerator





This function can be used to reach the selected heating level more quickly. The cooking zones will start at maximum power. Once the selected power level is reached, power is reduced.

- Use the Increase  and Decrease  buttons to select a power level ranging between 1 and 9 (also in double or triple mode).
- Press the Increase  and Decrease  buttons simultaneously for the cooking zone on which you wish to activate the accelerator function. The display alternately shows  and the power level that has just been selected.

Power level	Heating times with the  function activated (min)
1	2
2	3
3	4
4	5
5	6
6	7
7	8
8	10
9	12





Controls lock

The controls lock is a device that protects the appliance from accidental or inappropriate use. Useful for preventing accidental changes to set cooking values, the lock can be activated while the hob is on or off.

1. After switching on the hob, press the Controls lock button  for at least 2 seconds. An illuminated dot appears on the button to indicate that the controls are locked. Pressing any button will cause  or  to be displayed (depending on the model).
2. Press the Controls lock button  for at least 2 seconds. The lighted dot above the symbol switches off to indicate that the controls have been unlocked and any button can be pressed.









For safety reasons the ON/OFF button  remains active with at least one cooking zone switched on. The entire hob can be switched off at any time, even if the controls lock is active.

2. Press the Timer button  again. If at least one cooking zone is active a lighted dot comes on under the controls of the first active zone (from left to right).
3. Use the Increase  and Decrease  buttons to set the required automatic shut-down time (hold the buttons down to advance more quickly), or select an additional cooking zone using the Timer  button.
4. To modify the set time, press the Timer button  until an illuminated dot appears under the controls of the cooking zone for which you wish to make the modification.
5. At the end of the previously set time, the hob deactivates the cooking zone and warns the user with a series of buzzes. Press any button to stop the indication.

Minute minder timer (on some models only)

This function allows you to set a minute minder timer, which will sound a buzzer at the end of the pre-set time (from 1 to 99 minutes).

1. Press the Timer  button when the appliance is off.  appears on the display to indicate that the timer can be modified.
2. Use the  and  buttons to set the required minute minder time (press and hold to set the time more quickly).
3. At the end of the set time, the hob will warn the user with a series of buzzes. To stop this buzzer, press the Timer button .
4. To deactivate the minute minder timer during the countdown, zero its value using the Decrease button . When  appears on the display, the timer is deactivated.

Automatic shut-down timer (on some models only)

This function allows you to set a minute minder timer, which will sound a buzzer at the end of the pre-set time (from 1 to 99 minutes).

1. Press the Timer  button when the appliance is off. The display shows  to indicate that the timer can be modified.



If the automatic shut-down timer is activated and no cooking zone is active it functions like a minute minder timer.

Secondary menu



The hob has a secondary menu for activating or deactivating certain parameters:

1 = Automatic controls lock: activating this mode will cause the controls lock to activate automatically one minute after the last operation by the user.



2 = Showroom: activating this mode will cause the appliance to deactivate all the heating elements, while keeping the control panel active (useful for in-store demonstration purposes).

Every minute,  appears for one second on the display. To use the hob normally, set this mode to .







3 = ECO-Logic (on some models only): when activating this mode, the hob electronics will automatically adjust the power levels to stay within the set maximum power draw: 3 or 4 kW. To use the hob at maximum power, this mode has to be set to .

When installing for the first time, within two minutes of turning powering on to the hob, hold down the Increase  and Decrease  buttons for the first cooking zone (the one near

the  symbol).

The cooking zone display shows the number of the setting currently being modified (1 = Automatic controls lock, 2 = Showroom, 3 = ECO-logic) with its setting at the side ( : activated,  : deactivated).

For example,  indicates that the automatic controls Lock is deactivated.

Press the Increase  or Decrease  buttons to change the settings to  or . If the ECO-logic parameter is modified you can select the following values  (3 kW),  (4 kW),  (maximum power draw).

To change the subsequent settings, press the Controls lock button .

 If the hob is already installed and in use, cut the power supply to the hob. Switch the power back on and proceed as indicated above within two minutes.

Advice on energy-saving

The diameter of the base of the pan must correspond to the diameter of the cooking zone.

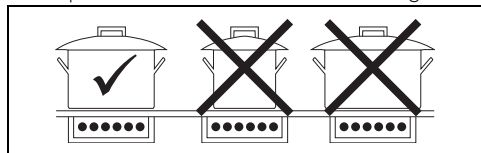

- When buying a pot, check whether the diameter indicated is that of the base or the top,
- as the top is almost always larger than the base.
- The base of the cookware must be thick and completely flat. In addition, the hob should be clean and dry as well.
- When preparing dishes with long cooking times, you can save time and energy by using a pressure cooker, which also makes it possible to preserve the vitamins in the food.
- Make sure that the pressure cooker contains enough liquid as, if there is not enough and it overheats, this may cause damage to both the pressure cooker and the cooking zone.
- If possible, always cover the pans with a suitable lid.

- Choose a pan suitable for the quantity of food to be cooked. A large, half-empty saucepan leads to a waste of energy.
- Do not use cast-iron cookware or cookware with a rough base.



If hob and oven are being used at the same time, under certain conditions the maximum power limit that can be used by your electrical system might be exceeded.

Cooking information table

Power level	Cooking mode	Suitable for...
0	OFF setting	Off
U	Dishwarming	Warming up dishes
1	Cooking small amounts of food (minimum power)	Melting butter, chocolate or similar products.
2	Cooking small amounts of food	Keeping small amounts of water on the boil, whisk egg yolk sauces or butter
3-4	Normal cooking	Heating solid or liquid food, keeping water on the boil, defrosting deep-frozen food, cooking 2 or 3 egg omelettes, fruit and vegetable dishes, various cooking processes
5	Cooking large amounts of food	Keeping water on the boil, cooking 4 or 6 egg omelettes, fruit and vegetable dishes, various cooking processes
6	Cooking large amounts of food, roast	Stewing meat, fish and vegetables, simmering food, making jams, etc.
7-8	Roasting larger pieces, frying with flour	Roasting meat, fish, steaks and liver; sautéing meat, fish, eggs, etc.
9-P	Roasting, browning, cooking (maximum power)	Deep-frying potatoes, etc., or bringing water to the boil rapidly.

Limiting the cooking duration

The hob has an automatic device which limits the duration of use.

If the cooking zone settings are not changed, the maximum duration of operation for each zone depends on the power level selected.

When the device for limiting the duration of use is activated, the cooking zone turns off, a short beep will be emitted and, if the zone is hot, the **H** symbol appears on the display.

Power level	Maximum cooking time (min)
U	600
1	600
2	360
3	300
4	240
5	180
6	120
7	120
8	120
9	70
P	70

Protection from overheating

If you are using the hob at full power for a long time, for the electronics it could be difficult to cool down, especially if the room temperature is high.

In this case, a device activates to disconnect the power to the front cooking zones,

H and **E** flash on the display.

If the temperature of the electronic circuit board does not decrease, the device will disconnect power to all the cooking zones

and **H1E2** will appear on the display (on some models only).

Cooking can be resumed once the temperature returns below alarm levels.

Other functions

If you press three or more controls at the same time or for a long period, (e.g. due to accidentally placing a saucepan on them or due to an overflow of liquid), an automatic device deactivates all the cooking zones, if they are on, and the display will show error **E2**

CLEANING AND MAINTENANCE

Cleaning the glass ceramic hob



See General safety instructions.

Cleaning the surfaces

To keep the surfaces in good condition, they should be cleaned regularly after use. Let them cool first.

Ordinary daily cleaning

Always and only use specific products that do not contain abrasives or chlorine-based acids. Pour the product onto a damp cloth and wipe the surface, rinse thoroughly and dry with a soft cloth or a microfibre cloth.



In case of stubborn dirt, clean when cold using a damp kitchen sponge and neutral detergent; then dry with a microfibre cloth.

Weekly cleaning

Clean and maintain the hob once a week using an ordinary glass ceramic cleaning product. Always follow the manufacturer's instructions. The silicon in these products creates a protective, water-repellent membrane which also resists dirt. All marks stay on the membrane and can therefore be removed easily. After cleaning, dry the surface with a clean cloth. Make sure that there is no detergent left on the cooking surface as it might undergo an aggressive reaction when heated up and could modify the structure of the cooking surface.

Food stains or residues

Light coloured marks from pans with aluminium bases can be easily cleaned off with a cloth moistened in vinegar. Remove any burnt-on residues after cooking; then rinse with water and dry thoroughly with a clean cloth. Dirt, which may have fallen on the hob while cleaning lettuce or potatoes, can scratch the hob when moving pans. Consequently, remove any dirt from the cooking surface immediately. Changes in colour do not affect the operation and stability of the glass. These are not alterations to the material of the hob but just residues which have not been removed and have then carbonised. Shiny surfaces can form due to the bases of pans, especially aluminium ones, rubbing on the surface, and due to the use of

unsuitable detergents. They are difficult to remove using conventional cleaning products. It may be necessary to repeat the cleaning process several times. Use of corrosive detergents or rubbing of pan bases can wear away the decoration on the hob over time and contribute to the formation of stains.



We recommend the use of cleaning products distributed by the manufacturer.



After cleaning, dry the appliance thoroughly to prevent any water or detergent from interfering with its operation or creating unsightly marks.

What to do if...

The hob does not work:

- Make sure that the hob is connected and that the main switch is turned on.
- Make sure that there is no power failure.
- Make sure that the fuse has not blown. In this case replace the fuse.
- Make sure that the circuit breaker of the residential electrical system has not tripped. In this case, reset the circuit breaker.

The cooking results are unsatisfactory:

- Make sure that the cooking temperature is not too high or too low.
- Make sure that the hob has proper ventilation and that the air intakes are completely free.

The hob smokes:

- Let the hob cool down and clean it once cooking is complete.
- Make sure that the food has not spilled out of the pan and use a larger cooking vessel, if needed.

The fuses blow or the circuit breaker of the residential electrical system trips repeatedly.

- Call Technical Support or an electrician.

There are cracks or fissures in the hob:

- Turn off the appliance immediately, disconnect the power supply and contact Technical Support.

INSTALLATION

Electrical connection



See General safety instructions.

General information

Check the mains characteristics against the data indicated on the plate.

The identification plate bearing the technical data, serial number and brand name is visibly positioned on the appliance.

Do not remove this plate for any reason.

The appliance must be connected to ground using a wire that is at least 20 mm longer than

The appliance can work in the following modes:

30 cm models:

220-240 V 1N \sim

3 x 1.5 mm²

three-core cable



60 cm models:

220-240 V 1N \sim

5 x 2.5 mm²

five-core cable

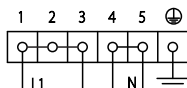

220-240 V 2 \sim

5 x 2.5 mm²

five-core cable

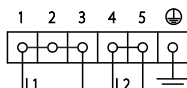

220-240 V 3 \sim

5 x 2.5 mm²

five-core cable

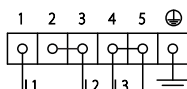

380-415 V 2N \sim

5 x 2.5 mm²

five-core cable

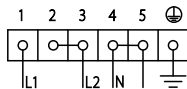

the other wires.

Terminal block connection

Arrange the cables in an orderly manner to avoid overlapping or contact with any jumpers. The cables must be of the correct length to avoid build-up/twisting inside the terminal box.

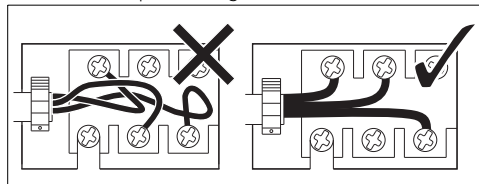

The aforementioned power cables are sized taking into account the coincidence factor (in compliance with standard EN 60335-2-6).



Always use the jumper provided, if any, for each connection; terminals 2 and 3, 4 and 5 must always be connected.

60 - 77 - 90 cm models:

220-240 V 1N~

3 x 6 mm²

three-core cable

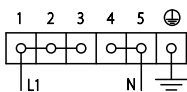

220-240 V 2~

3 x 6 mm²

three-core cable

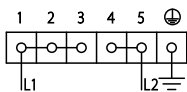

380-415 V 2N~

4 x 4 mm²

four-core cable

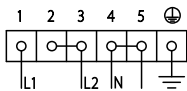

220-240 V 3~

4 x 4 mm²

four-core cable

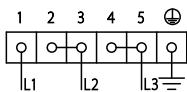

380-415 V 3N~

5 x 2.5 mm²

five-core cable

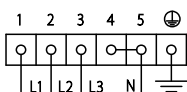

Always use the jumper provided, if any, for each connection; terminals 4 and 5 must always be connected.

60 - 90 cm models (limited to 3 kW)

220-240 V 1N~

3 x 1.5 mm²

three-core cable

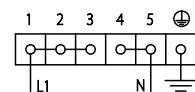

Section cut from the countertop

Safety instructions for positioning and installation



See General safety instructions.

- Installation can be carried out on various materials such as masonry, metal, solid wood or plastic laminated wood as long as they are heat resistant (>90°C).
- Veneers, adhesives or plastic coatings on adjacent furniture should be temperature-resistant (>90°C), otherwise they might warp over time.
- If the piece of furniture does not have the required recess opening, either it will have to be cut or masonry work carried out by a competent technician.
- The minimum clearance between exhaust hoods and the cooking surface must be at least the distance indicated in the exhaust

hood installation instructions.

- The minimum clearances must also be respected for the edges of the hob on the back as indicated in the assembly instructions.
- If the appliance is to be installed above an oven, the oven must be fitted with a cooling fan.

Appliance overall dimensions (mm)

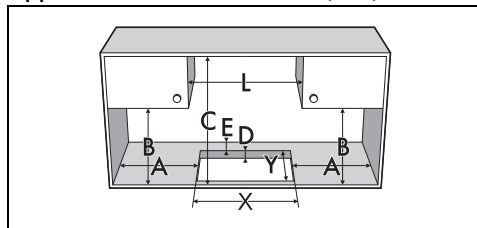

A	B	C	D	E
min. 50	min. 460	min. 750	20÷60	min. 50

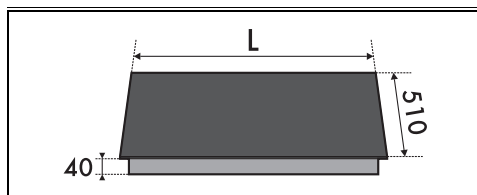

with frame:

L	X	Y
570	560	500
760	750	500

with bevelled edge:

L	X	Y
300	270	490
600	565	490
770	745	490
900	850	490

with straight edge:

For this kind of hobs additional milling is needed in the recessed hole if you wish to install the hob flush with the work surface.

L	X	Y	G	H
600	565	490	604	514
770	745	490	774	514
900	865	490	904	514

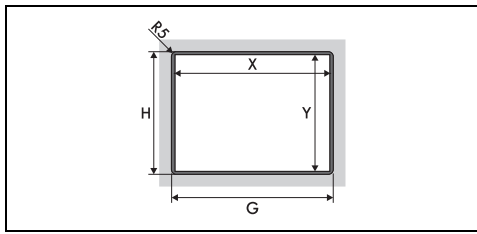

Hob seal

To prevent leakage of liquid between the frame of the hob and the countertop, place the adhesive seal provided along the entire outer edge of the hob before assembly.

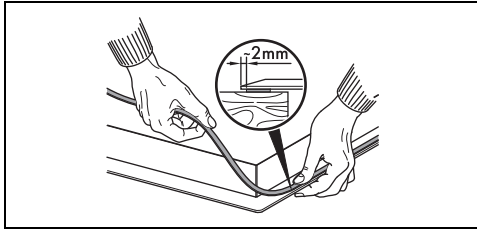

! Do not use silicone to secure the hob. This would make it impossible to remove the hob without damaging it.

In the case of flush mounting, after placing the adhesive seal (A) on the glass surface and after positioning and securing the hob, fill the edges with insulating silicone (B) and wipe off any excess. If for any reason the hob needs to be removed, cut the silicone using a cutter before attempting to remove it (C).

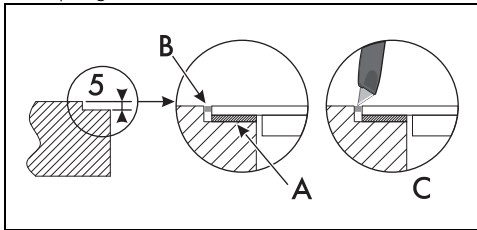

Mounting

On top of oven built-in unit

The clearance between the hob and the kitchen furniture or other installed appliances must be enough to ensure sufficient ventilation and air discharge. If installed above an oven, a space must be left between the bottom of the hob and

the top of the appliance installed below.

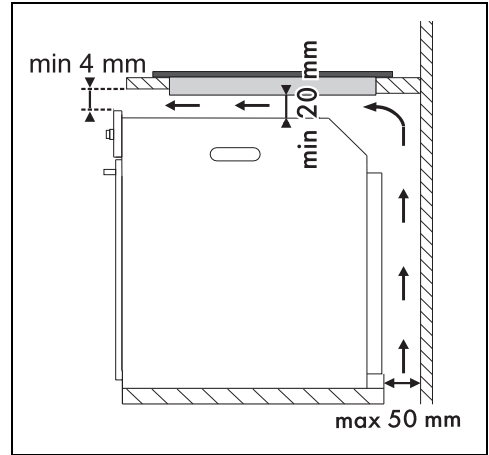

On top of empty kitchen unit or drawers

If there are other pieces of furniture (lateral walls, drawers, etc.), dishwashers or fridges under the hob, a double-layer wooden base must be installed at least 20 mm from the bottom of the hob to avoid any accidental contact. It must only be possible to remove the double-layer base using suitable equipment.

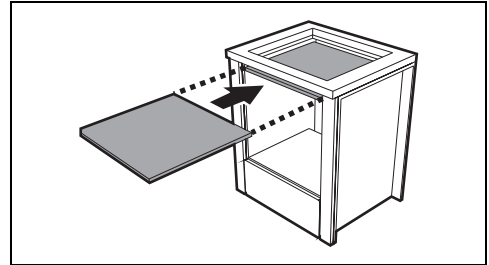

opens on bottom:

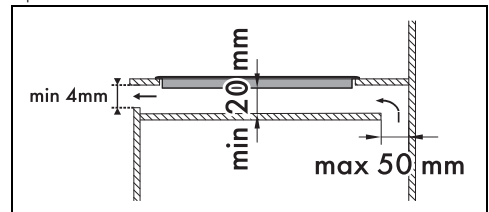

opens on rear:

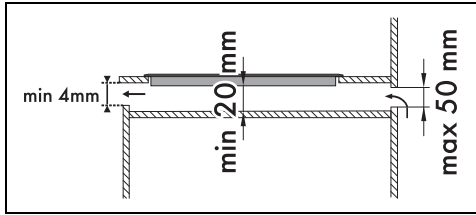

Failure to install the double-layer wooden base exposes the user to possible accidental contact with sharp or hot parts.



If installed on top of an oven, the latter must be equipped with a cooling fan.

Fixing to the built-in cabinet



The clips should not be installed at the front of the appliance.

To ensure the hob is fixed and centred as accurately as possible, the clips provided must be positioned as described below:

1. Fit the clips by gently pressing them horizontally into the appropriate space.
2. Then turn them upwards to fix them in place.

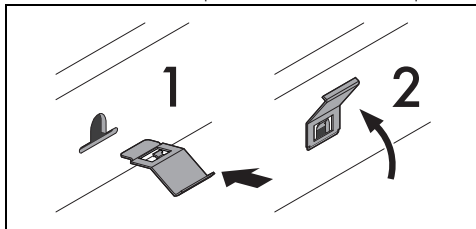

Fixing brackets

Screw the mounting brackets into the holes on the sides of the bottom casing to fasten the hob correctly to the structure.

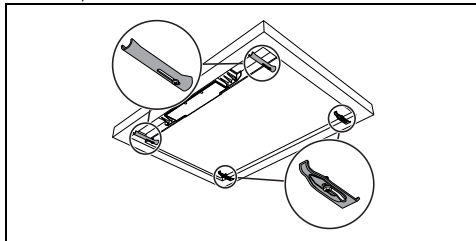

If tightened too much the glass may be strained and crack.

Fixed connection

Fit the power line with an all-pole circuit breaker with a contact separation distance sufficient to provide complete disconnection in category III overvoltage conditions, pursuant to installation regulations.

For the Australian/New Zealand market:

The circuit breaker incorporated in the fixed connection must comply with AS/NZS 3000.

Testing

At the end of installation, carry out a brief inspection test. If it fails to work, after making sure that you have carried out the instructions correctly, contact Technical Support.

Instructions for the installer

- If you use a plug (if present) to connect to the power supply, the plug must be accessible after installation.
- Do not bend or trap the power cable.
- The appliance must be installed according to the installation diagrams.
- If the appliance does not work correctly after having carried out all the checks, contact your local Authorised Service Centre.
- Once the appliance has been installed, please explain to the user how to use it correctly.