

Contents

1 Instructions	32
1.2 Appliance purpose	35
1.7 How to read the user manual	37
2 Description	38
2.1 General Description	38
2.2 Cooking zones	38
2.3 Symbols	40
3 Use	41
3.1 Preliminary operations	42
3.2 Using the hob	42
4 Cleaning and maintenance	50
4.1 Cleaning the surfaces	50
4.2 Ordinary weekly cleaning	50
4.3 Food stains or residues	50
4.4 What to do if...	52
5 Installation	53
5.1 Safety instructions	53
5.2 Section cut from the countertop	53
5.3 Mounting	56
5.4 Electrical connection	57
5.5 Instructions for the installer	58

TRANSLATION OF THE ORIGINAL INSTRUCTIONS

We advise you to read this manual carefully, which contains all the instructions for maintaining the appliance's aesthetic and functional qualities.

For further information on the product: www.smeg.com



1 Instructions

1.1 General safety instructions

Risk of personal injury

- During use the appliance and its accessible parts become very hot.
- Never touch the heating elements during use.
- **WARNING:** if the surface is cracked, switch off the appliance to avoid the possibility of electric shock.
- Protect your hands wearing heat-proof gloves during use.
- Never try to put out a fire or flames with water: turn off the appliance and smother the flames with a fire blanket or other appropriate cover.
- The appliance is not intended for use by persons (including children) with reduced physical, sensory or mental capabilities, or lack of experience and knowledge, unless they have been given supervised or instruction concerning use of the appliance by a responsible person for their safety.
- Young children should be supervised to ensure that they do not play with the appliance.
- Keep children under eight years of age at a safe distance if they are not constantly supervised.
- Do not allow children younger than 8 years old to come near the appliance when in operation.
- Cleaning and maintenance must not be carried out by unsupervised children.
- Be aware of how rapidly the cooking zones heat up. Do not place empty pans on the heat: danger of overheating.
- Fats and oils can catch fire if they overheat. Do not leave the appliance unattended while preparing foods containing oils or fats. If fats or oils catch fire, never put water on them. Place the lid on the pan and turn off the relevant cooking zone.
- **CAUTION** - The cooking process has to be supervised. A short term cooking processes has to be supervised continuously.
- **WARNING** - Unattended cooking on a hob with fat or oil can be dangerous and may result in a fire.
- When in use, do not place metal objects, such as dishes or cutlery, on the surface of the cooktop as they may overheat.
- Do not insert pointed metal objects (cutlery or utensils) into the slots in the appliance.
- Do not pour water directly onto very hot trays.



- Do not use or store flammable materials near the appliance or directly underneath the cooktop.
- NEVER USE AEROSOL CANS NEAR THE APPLIANCE WHILE IT IS IN OPERATION.
- Switch the appliance off immediately after use.
- DO NOT MODIFY THIS APPLIANCE.
- Before carrying out any work on the appliance (installation, maintenance, positioning or moving), wear personal protective equipment.
- Before carrying out any work on the appliance, disconnect the mains power supply.
- Have authorised persons carry out installation and assistance interventions according to the standards in force.
- Do not try to repair the appliance yourself or without the intervention of authorised persons.
- If the power supply cord is damaged, it must be replaced by the manufacturer or its service agent or a similarly qualified person in order to avoid hazard.
- Use wooden or plastic utensils.
- Do not seat on the appliance.
- Do not use as a support surface.
- Do not obstruct ventilation openings and heat dispersal slots.
- Do not use a steam cleaner to clean this appliance.
- Never leave the appliance unattended during cooking operations in which fats or oils could be released that could overheat and catch fire. Be very careful.
- Metallic objects such as knives, forks, spoons and lids should not be placed on the hotplate since they can get hot.
- Danger of fire: Do not store objects on the cooking surface.
- DO NOT USE THE APPLIANCE TO HEAT ROOMS FOR ANY REASON.
- The cooking vessels or griddle plates should be placed inside the perimeter of the cooktop.
- All cookware must have smooth, flat bottoms.
- If any liquid does boil over or spill, remove the excess from the cooktop.
- Take care not to spill acidic substances such as lemon juice or vinegar onto the cooktop.

Risk of damaging the appliance

- Do not use abrasive or corrosive detergents (e.g. scouring powders, stain removers and



Instructions

- Do not spill sugar or sweet mixtures on the cooktop during cooking.
- Do not place materials or substances that could melt (plastic or aluminium foil).
- Do not put empty pans or frying pans on switched on cooking zones.
- Do not use rough or abrasive materials or sharp metal scrapers.
- Do not use cleaning products containing chlorine, ammonia or bleach on steel parts or parts with metallic surface finishes (e.g. anodizing, nickel- or chromium-plating).
- The appliance must be connected to earth in compliance with electrical system safety standards.
- Use cables withstanding a temperature of at least 90°C.
- The tightening torque of the screws of the terminal supply wires must be 1.5 - 2 Nm.
- The power cable must only be installed and replaced by authorised persons.
- If the electrical supply is restricted, means of all-pole disconnection must be accessible and incorporated in the fixed wiring in accordance with the wiring rules.

Installation

- THIS APPLIANCE **MUST NOT BE INSTALLED** IN BOATS OR CARAVANS.
- Position the appliance into the cabinet cutout with the help of a second person.
- Check that the piece of furniture material is heat resistant.
- Check that the piece of furniture has the required slots.
- To prevent overheating, the appliance must not be installed behind a decorative door or a panel.
- Have the electrical connection performed by authorised persons.
- If cracks or fissures form, or if the glass ceramic cooking surface breaks, turn off the appliance immediately. Disconnect the power supply and call Technical Support.
- Avoid hard, solid objects falling on the cooking surface.
- Do not use the cooktop if the pyrolytic cycle is taking place inside any oven installed below.
- Do not touch or clean the cooktop surface during operation or when the residual heat indicator lights are still on.
- Activate the control lock when you have children or pets which



- could reach the cooktop.
- After use the cooking zones remain hot for a certain period of time after they have been turned off. Do not touch the cooktop surfaces.
- Switch off the hot plates after use. Never rely solely on the cookware detector.
- Supervise children carefully as they cannot easily see the indication that there is residual heat. Keep children away from the cooking zones.
- The glass ceramic surface is highly resistant to impact. However, prevent hard, solid objects falling onto the cooking surface as they may cause it to break if they are sharp.
- The glass ceramic cooking surface must not be used as a surface for placing objects.
- Remove any traces of liquid from the lid (if fitted) before opening.
- Leave the cooking surface to cool before closing the lid.
- People who have pacemakers or other similar devices fitted must make sure that the operation of these devices is not jeopardised by the inductive field, whose frequency range is between 20 and 50 kHz.

- In conformity with the provisions regarding electromagnetic compatibility, the electromagnetic induction cooktop comes under group 2 and class B (EN 55011).

1.2 Appliance purpose

- This appliance is intended for cooking food in the home environment. Every other use is considered improper.
- This appliance is not intended to be operated by means of external timer or separate remote control system.

1.3 Manufacturer's liability

- The manufacturer declines all liability for damage to persons or property caused by:
- Use of the appliance other than that specified
- Failure to comply with the instructions in the user manual
- Tampering with any part of the appliance
- The use of non-original spare parts.

1.4 Identification plate

The identification plate bears the technical data, serial number and brand name of the appliance. Do not remove the identification plate for any reason.



Instructions

1.5 This user manual

This user manual is an integral part of the appliance and must therefore be kept in its entirety and within the user's reach for the whole working life of the appliance.

Read this user manual carefully before using the appliance.

1.6 Disposal



This appliance must be disposed of separately from other waste (Directives 2002/95/EC, 2002/96/EC, 2003/108/EC). The appliance does not contain substances in quantities sufficient to be considered hazardous to health and the environment, in accordance with current European directives.

To dispose of the appliance:

- Deliver the appliance to the appropriate recycling centre for electrical and electronic equipment waste, or return it to the retailer when purchasing an equivalent product, on a one for one basis.

Our appliances are packaged in non-polluting and recyclable materials.

- Deliver the packing materials to the appropriate recycling centre.



Plastic packaging Danger of suffocation

- Do not leave the packaging or any part of it unattended.
- Do not let children play with the plastic bags.



Power voltage Danger of electrocution

- Disconnect the mains power supply.



1.7 How to read the user manual

This user manual uses the following reading conventions:

Instructions



General information on this user manual, on safety and final disposal.

Description



Description of the appliance and its accessories.

Use



Information on the use of the appliance and its accessories, cooking advice.

Cleaning and maintenance



Information for proper cleaning and maintenance of the appliance.

Installation



Information for the qualified technician: Installation, operation and inspection.



Safety instructions



Suggestion / Information

1. Sequence of instructions for use.

- Standalone instruction.



Description

2 Description

2.1 General Description

Advantages of induction cooking



The hob is equipped with an induction generator for each cooking zone. Each generator located under the glass ceramic cooking surface creates an electromagnetic field which induces a thermal current in the base of the pan. This means the heat is no longer transmitted from the hob to the pan but created directly inside the pan by the inductive current.

- Energy saving thanks to the direct transmission of energy to the pan (suitable magnetisable cookware is required) compared to traditional electric cooking.
- Improved safety as the energy is only transmitted to the pan placed on the hob.
- High level of energy transmitted from the induction cooking zone to the base of the pan.
- Rapid heating speed.
- Reduced danger of burns as the cooking surface is only heated under the base of the pan; foods which overflow do not stick.

2.2 Cooking zones

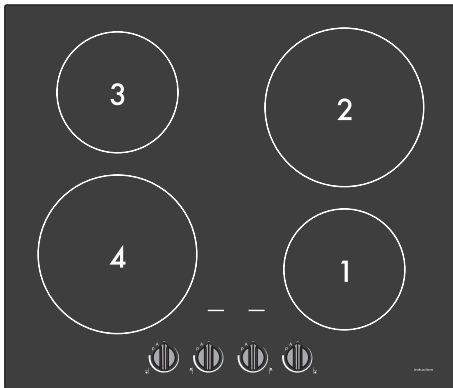

Model with straight edge

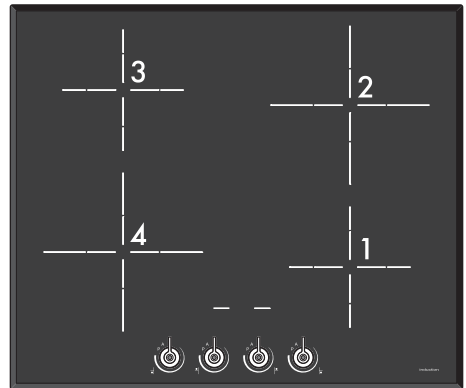

Model with angled edge

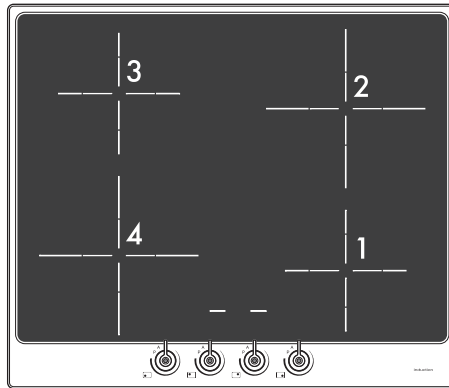
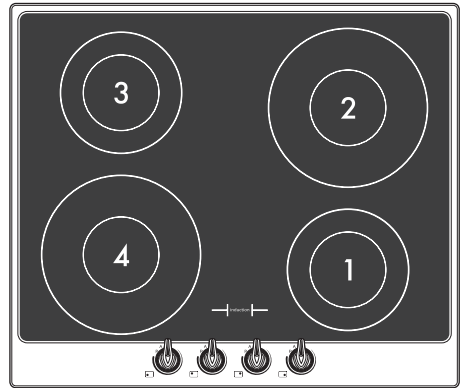
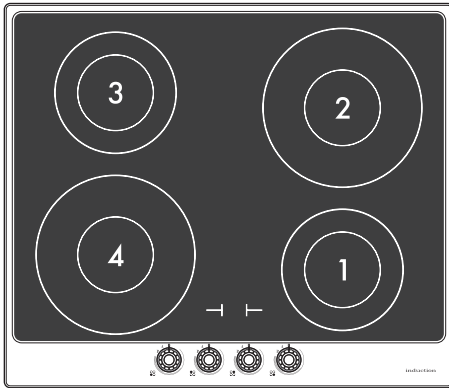

Model with frame

Zone	Diameter external (mm)	Min. pan Ø (mm)	Max. power draw (W) *	Power draw in Booster function (W) *
1	180	110	1300	1400
2	230	120	2300	3000
3	180	110	1300	1400
4	230	120	2300	3000

* power levels are approximate and may vary according to the settings made and the mains voltage.



Description

2.3 Symbols

Knobs

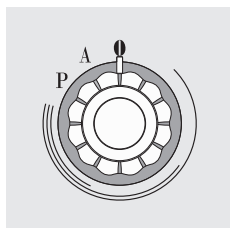
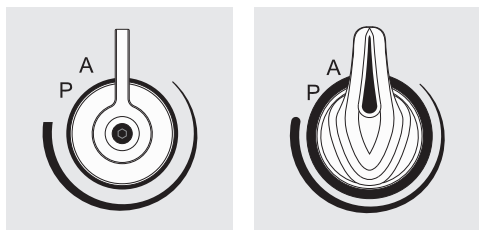
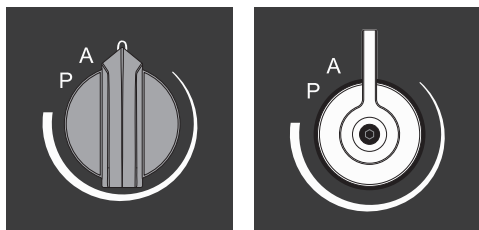

OFF setting **0**

The cooking zone is OFF.

Booster setting **P**

Using this setting the Booster function of the cooking zone activates.

Accelerator setting **A**

Using this setting the accelerator function of the cooking zone activates.

Cooking zones

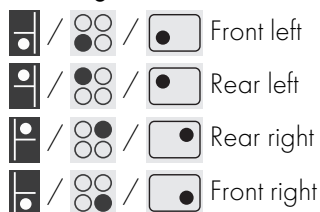

Turn the knob clockwise or anti-clockwise to increase or decrease the power for the cooking zone whose value is shown on the displays.



3 Use

Instructions



High temperature Danger of burns

- Protect your hands by wearing heat-proof gloves during use.
- Do not touch or clean the hob surface during operation or when the residual heat indicator lights are still on.
- Do not put empty pans or frying pans on switched on cooking zones.
- Keep children under the age of 8 away from the appliance when it is in use.
- Activate the controls lock when you have children or pets which could reach the hob.
- After use the cooking zones remain hot for a certain period of time after they have been turned off. Do not touch the hob surfaces.



High temperature Danger of fire or explosion

- Do not use or leave flammable materials near the appliance or directly underneath the hob.
- Do not cook in closed tins or containers, plastic kitchenware or containers.
- Do not leave the appliance unattended during cooking operations where fats or oils could be released.
- In case you notice cracks or fissures or you cannot turn off the appliance, disconnect the power supply and contact the Assistance Centre.



Improper use Risk of damage to surfaces

- Do not use the hob if the pyrolytic cycle is taking place inside any oven installed below.
- Never place pans with bases which are not perfectly flat and smooth.
- Avoid hard, solid objects falling on the cooking surface.
- In case you notice cracks or fissures, turn off the appliance immediately, disconnect the power supply and contact Technical Support.
- Do not use the hob as a support surface.



3.1 Preliminary operations

In order to remove any moisture that could have accumulated during the manufacturing process and for the electronic circuits and control keypad to work properly:

1. Remove the protective films from the external surfaces of the appliance and accessories.
2. Remove any labels (apart from the technical data plate).
3. Place a pan full of water on each of the front cooking zones and switch them on to the maximum power setting for at least 30 minutes.
4. After 30 minutes, switch off the front cooking zones and repeat this operation for the rear cooking zones and any central cooking zone.
5. If after carrying out the above operations the controls do not work properly, it might be necessary to extend the operations until the moisture has completely evaporated.

3.2 Using the hob



On first connection to the electrical mains, an automatic check will be carried out that will switch on all indicator lights for a few seconds.

All the appliance's control and monitoring devices are located together on the front panel. The relevant cooking zone is indicated next to each knob.

Just turn the knob clockwise to the required power setting.

Cookware suitable for use in induction cooking

Cookware used on the induction cooking surface must be made of metal, with magnetic properties and a sufficiently large base.

Suitable cookware:

- Enamelled steel cookware with thick bases.
- Cast iron cookware with an enamelled base.
- Cookware in multilayer stainless steel, ferritic stainless steel and aluminium with a special base.



Unsuitable cookware:

- Copper, stainless steel, aluminium, fireproof glass, wood, ceramic and terracotta cookware.

To see whether the pan is suitable, bring a magnet close to the bottom: if it is attracted, the pan is suitable for induction cooking. If you do not have a magnet, you can put a small amount of water in the pan, place it on a cooking zone and start the hot plate. If the  symbol appears on the display, it means the pan is not suitable.

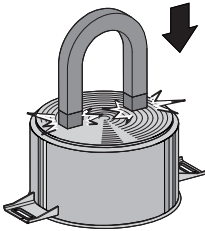

Use only cookware with a perfectly flat bottom which is suitable for induction hot plates. Using cookware with an irregular bottom could jeopardise the efficiency of the heating system and prevent cookware from being detected on the hot plate.

Cookware recognition

When there is no saucepan on a cooking zone or if the saucepan is too small, no energy will be transmitted and the  symbol will appear on the display.

If there is a suitable saucepan on the cooking zone, the recognition system detects it and switches on the hob to the power level set using the knob. Energy transmission is also interrupted when the saucepan is removed from the cooking zone (the  symbol will be shown on the display).

If the cookware recognition function is activated in spite of the saucepan or frying pan on the cooking zone being smaller than the zone itself, only the necessary energy will be transmitted.

Cookware recognition limits: The minimum diameter of the pan base is indicated by a circle or a cross on the cooking zone (depending on the model).

Pans with smaller diameters risk not being detected and therefore not activating the inductor.



Use

Limiting the cooking duration

The hob has an automatic device which limits the duration of use.

If the cooking zone settings are not changed, the maximum duration of operation for each zone depends on the power level selected.

When the device for limiting the duration of use is activated, the cooking zone turns off, a short alert sounds and, if the zone is hot,

the **H** symbol appears on the display.

Set power level	Maximum cooking duration in hours
1	8
2	6
3 - 4	5
5	4
6 - 7 - 8 - 9	1 ½

Protection from overheating

If the hob is used on full power for a long period, the electronics will have trouble cooling down if the room temperature is high.

To avoid excessively high temperatures forming in the electronics, the power to the cooking zone is reduced automatically.

Advice on energy-saving

- The diameter of the base of the pan must correspond to the diameter of the cooking zone.



- When buying a pan, check whether the diameter indicated is that of the base or the top of the pan, as the top is almost always larger than the base.
- When preparing dishes with long cooking times, you can save time and energy by using a pressure cooker, which also helps to retain vitamins contained in the food.
- Make sure that the pressure cooker contains enough liquid as, if there is not enough and it overheats, this may cause damage to both the pressure cooker and the cooking zone.
- If possible, always cover pans with a suitable lid.
- Choose a pan suitable for the quantity of food to be cooked. A large, half-empty saucepan leads to a waste of energy.



Under certain circumstances, if the hob and the oven are being used at the same time, the maximum power limit that can be used by the electrical system might be exceeded.



Power levels

The power in the cooking zone can be adjusted to various levels. The table shows the levels suitable for various types of cooking.

Power level	Suitable for:
0	OFF setting
1 - 2	Cooking small amounts of food (minimum power)
3 - 4	Cooking
5 - 6	Cooking large quantities of food, roasting larger portions
7 - 8	Roasting, slow frying with flour
9	Roasting
p *	Roasting / browning, cooking (maximum power)

* see booster function

Residual heat



Improper use Danger of burns

- Supervise children carefully as they cannot easily see the residual heat indicator. The cooking zones remain hot for a certain period of time even after they have been turned off. Make sure that children never touch the hob.

If the cooking zone is still hot after being switched off, the **H** symbol will be displayed on the display. The symbol clears once the temperature drops below 60°C.

Booster function



The booster function allows you to activate the cooking zone at maximum power as long as 5 minutes. It can be used to bring a large quantity of water to a boil rapidly or to broil meat.

- Turn the knob clockwise to position **P** for two seconds and then release it. The display shows the **P** symbol.
(Only for cooking zones **2** and **4**): After 5 minutes the booster function will automatically be disabled and cooking will continue at power level **9**.



The Booster function has priority over the heating accelerator function.



Heating accelerator



Each cooking zone is equipped with a heating accelerator that allows the maximum power to be delivered for a time that is proportional to the selected power (the zone is switched on at the highest setting and then continues at the selected power level).

1. Turn the knob anti-clockwise to position **A** and release it. The display shows the **A** symbol.
2. Select the required heating power (**1 - 8**) within 3 seconds. The selected power and the **A** symbol will flash alternately on the display.

The power level can be increased at any moment. The "maximum power" period will automatically be modified.



Turn the knob to power level **9** to disable the heating accelerator. Then set the knob to the required heating level (**1...8**).

If the heating accelerator has been set to **9**, turn the knob anti-clockwise.

Power control

The hob is fitted with a power control module that optimises/limits consumption. If the overall set power level exceeds the maximum limit permitted, the electronic circuit board will automatically manage the power supplied by the hot plates.

The module tries to maintain the maximum deliverable power levels. Levels set by the automatic control will appear on the display.

The flashing of a power level indicates that it will be automatically limited to a new level selected by the power control module.



Priority is given to the first zone that is set.



The power control module does not affect the total power consumption of the appliance.



Controls lock



The controls lock is a device that protects the appliance from accidental or inappropriate use.

1. When all the cooking zones are turned off, simultaneously turn the two cooking zone control knobs anti-clockwise to the left (position **A**).

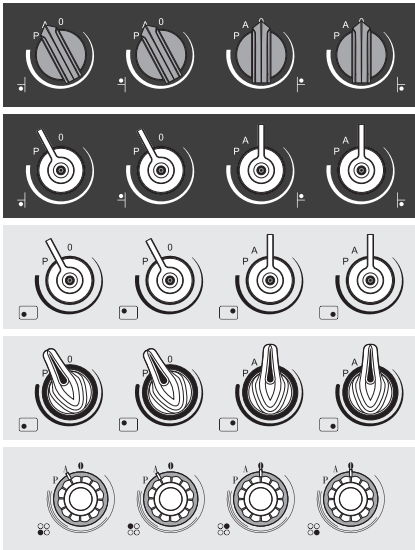

2. Keep them turned until the **L** symbols appear on the display.
3. Release the knobs.

In order to remove the control lock repeat the same operations described previously.



If a knob is turned to **A** for more than 30 seconds, an error message will appear on the displays **E**.

Error codes

If the display shows one of the following error codes **E**, **E**, contact Technical Assistance.

Power limitation



The induction hob is configured to operate at **7.4 kW**, but the power can be limited so that it can work at **4.5 kW, 3.8 kW, 3 kW, 2.6 kW** or **1.9 kW**.

1. Disconnect the appliance from the mains power supply and wait 10 seconds before turning the power back on.



The power level has to be set within 2 minutes from the power being switched on.



Use

- Turn and hold the front left and front right cooking zone control knobs anti-clockwise (position **A**) at the same time.

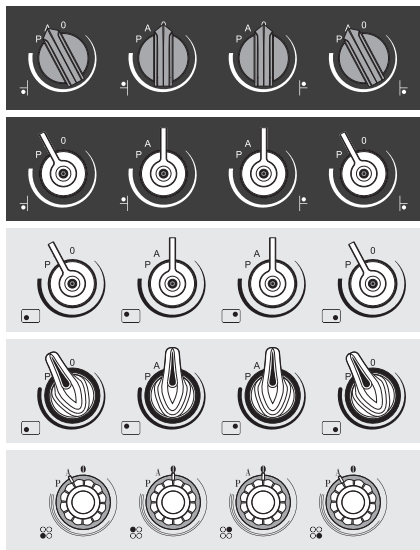

The rear left and rear right cooking zone displays will indicate the power levels "7." and "4".

- Release the knobs.
 - Turn and hold both knobs anti-clockwise again.
- The rear left and rear right cooking zone displays will indicate the power levels "4." and "5".
- Release the knobs.
 - Turn and hold both knobs anti-clockwise again.

The rear left and rear right cooking zone displays will indicate the power levels "3." and "8".

- Release the knobs.
- Turn and hold both knobs anti-clockwise again.

The rear left and rear right cooking zone displays will indicate the power levels "3." and "0".

- Release the knobs.
- Turn and hold both knobs anti-clockwise again.

The rear left and rear right cooking zone displays will indicate the power levels "2." and "6".

- Release the knobs.
- Turn and hold both knobs anti-clockwise again.

The rear left and rear right cooking zone displays will indicate the power levels "1." and "9".

- Release the knobs.



After having released the knobs at the required power level, wait until the displays turn off.



The power level can be changed again up to 4 minutes after the displays have turned off (without having to disconnect the appliance from the power supply).



To reset the product to its original power setting (or to a different power level), repeat the configuration procedure.



The last power setting will remain in memory even in the event of a power failure.

Possible cooking zone combinations

POWER	Zone 1	Zone 2	Zone 3	Zone 4
7.4 kW	9	9	9	9
	7	P	7	P
	P	9	7	P
	P	9	P	9
	7	9	P	9
4.5 kW	8	8	8	8
	8	-	9	9
	8	8	-	9
	-	8	8	9
	9	8	9	-
	9	-	9	8
	8	9	-	8
3.8 kW	-	9	8	8
	7	7	7	7
	-	-	9	9
	-	8	-	9
	9	-	-	9
	-	-	7	P
	8	-	-	P
	9	-	P	7
	9	7	P	-
P	7	9	-	
P	-	9	7	

POWER	Zone 1	Zone 2	Zone 3	Zone 4
3.0 kW	8	-	8	8
	-	8	-	8
	-	-	7	9
	7	-	-	9
	-	8	9	-
	9	-	9	-
	-	8	9	-
	9	-	9	-
	-	-	9	8
	7	-	7	7
2.6 kW	-	7	-	7
	-	-	8	8
	8	-	-	8
	9	-	9	-
	-	7	9	-
	-	-	9	7
	9	7	-	-
	9	-	-	7
1.9 kW	8	8	-	-
	7	-	-	7
	-	-	7	7
	-	-	-	8
	7	-	9	-
	-	8	8	-
-	8	-	-	



Cleaning and maintenance

4 Cleaning and maintenance

Instructions



Improper use

Risk of damage to surfaces

- Do not use steam jets to clean the appliance.
- Do not spill sugar or sweet mixtures on the hob during cooking.
- Do not place materials or substances that could melt (plastic or aluminium foil).
- Do not use cleaning products containing chlorine, ammonia or bleach on parts made of steel or that have metallic surface finishes (e.g. anodizing, nickel- or chromium-plating).
- Do not use abrasive or corrosive detergents (e.g. scouring powders, stain removers and metallic sponges) on glass parts. Use wooden or plastic utensils.



We recommend the use of cleaning products distributed by the manufacturer.

4.1 Cleaning the surfaces

To keep the surfaces in good condition, they should be cleaned regularly after use. Let them cool first.

4.2 Ordinary weekly cleaning

Clean and maintain the hob once a week using an ordinary glass cleaning product. Always follow the manufacturer's instructions. The silicon in these products creates a protective, water-repellent membrane which also resists dirt. All marks stay on the membrane and can therefore be removed easily. After cleaning, dry the surface with a clean cloth. Make sure that there is no detergent left on the cooking surface as it will undergo a corrosive reaction when heated up and could modify the structure of the cooking surface.

4.3 Food stains or residues

Light coloured marks from pans with aluminium bases can be easily cleaned off with a cloth moistened in vinegar.

Remove any burnt-on residues after cooking; then rinse with water and dry thoroughly with a clean cloth.

Dirt which may have fallen on the hob while cleaning lettuce or potatoes can scratch the hob when moving pans.

Consequently, remove any dirt from the cooking surface immediately.



Changes in colour do not affect the operation and stability of the glass. These are not alterations to the material of the hob but just residues which have not been removed and have then carbonised.

Shiny surfaces can form due to the bases of pans, especially aluminium ones, rubbing on the surface, and due to the use of unsuitable detergents. They are difficult to remove using conventional cleaning products. It may be necessary to repeat the cleaning process several times. Use of corrosive detergents or rubbing of pan bases can wear away the decoration on the hob over time and contribute to the formation of stains.



After cleaning, dry the appliance thoroughly to prevent any water or detergent from interfering with its operation or creating unsightly marks.

Knobs



Do not use aggressive products containing alcohol or products for cleaning steel and glass when cleaning the knobs, as these products could cause permanent damage.

The knobs should be cleaned with a soft cloth dampened with lukewarm water, then dried carefully. They can be removed by pulling them out from their housings.



Cleaning and maintenance

4.4 What to do if...

The hob does not work:

- Make sure that the hob is connected and that the main switch is turned on.
- Make sure that there is no power failure.
- Make sure that the fuse has not blown. In this case replace the fuse.
- Make sure that the circuit breaker of the residential electrical system has not tripped. In this case, reset the circuit breaker.

The cooking results are unsatisfactory:

- Make sure that the cooking temperature is not too high or too low.

The hob smokes:

- Let the hob cool down and clean it once cooking is complete.
- Make sure that the food has not spilled out of the pan and use a larger cooking vessel, if needed.

The fuses blow or the circuit breaker of the residential electrical system trips repeatedly.

- Call Technical Support or an electrician.

There are cracks or fissures in the hob:

- Turn off the appliance immediately, disconnect the power supply and contact Technical Support.



5 Installation

5.1 Safety instructions



Heat production during appliance operation

Risk of fire

- Check that the carcass material is heat resistant.
- Check that the carcass has the required openings.
- **WARNING:** The temperature of the surface is more than 95°C. Access to the lower part of the hob must be limited in order to avoid hazards.

Veneers, adhesives or plastic coatings on adjacent furniture should be temperature-resistant (>90°C), otherwise they might warp over time.

The minimum clearance between exhaust hoods and the cooking surface must be at least the distance indicated in the exhaust hood installation instructions.

The minimum clearances must also be respected for the edges of the hob on the back as indicated in the mounting illustrations.

5.2 Section cut from the countertop



The following operation requires building and/or carpentry work and must therefore be carried out by a competent tradesman.

Installation can be carried out on various materials such as masonry, metal, solid wood or plastic laminated wood as long as they are heat resistant (>90°C).

Make a hole in the countertop of the unit according to the dimensions shown in the figure (mm).

Hobs with frame and angled edge

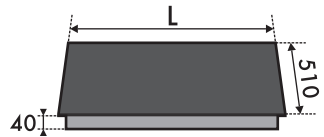

L	X	Y
600	555-560	478÷482

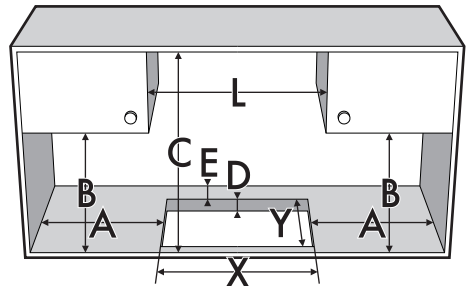

A	B	C	D	E
min. 50	min. 460	min. 750	20-60	min. 50



Installation

Hob seal

To prevent leakage of liquid between the frame of the hob and the countertop, place the adhesive seal provided along the entire outer edge of the hob before assembly.

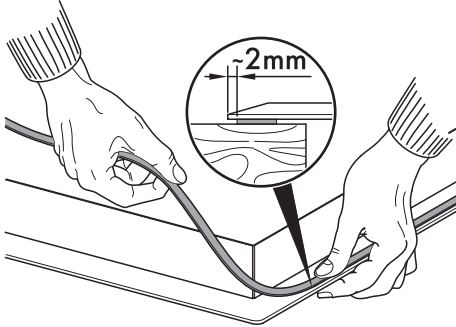

Do not use silicone to secure the hob. This would make it impossible to remove the hob, if necessary, without damaging it.

Hobs with a straight edge

For this kind of hobs additional milling is needed in the recessed hole if you wish to install the hob flush with the work surface.

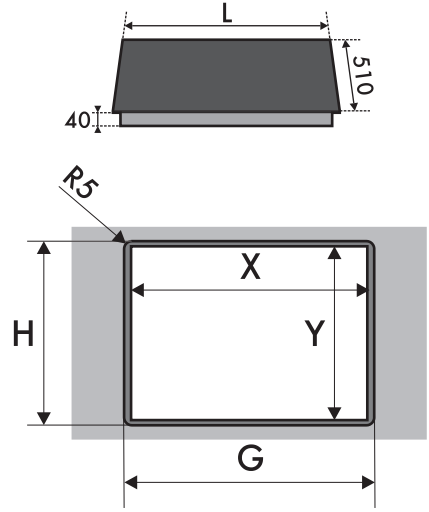

L	X	Y	G	H
600	555-560	478-482	604	514

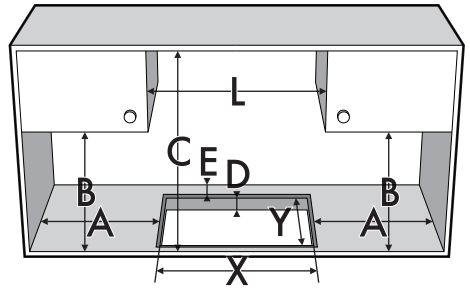

A	B	C	D	E
min. 50	min. 460	min. 750	20-60	min. 50



After laying the adhesive seal (A) on the glass surface and after positioning and securing the hob, fill the edges with insulating silicone (B) and wipe away any excess.

In the event the hob needs to be removed, cut the silicone using a cutter before attempting to remove it (C).

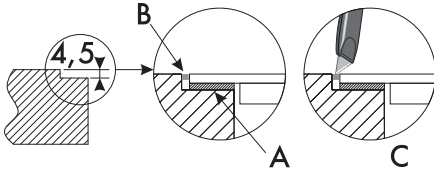

Spring clips

To ensure the hob is fixed and centred as accurately as possible, the clips provided must be positioned as described below:

1. Fit the clips by gently pressing them horizontally into the appropriate space.

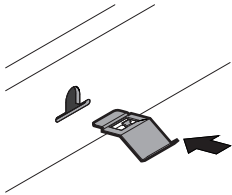

2. Then turn them upwards to fix them in place.

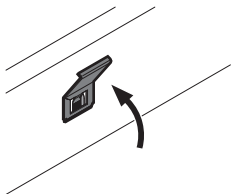

Fixing brackets

- Screw the mounting brackets into the holes on the sides of the bottom casing to fasten the hob correctly to the structure.

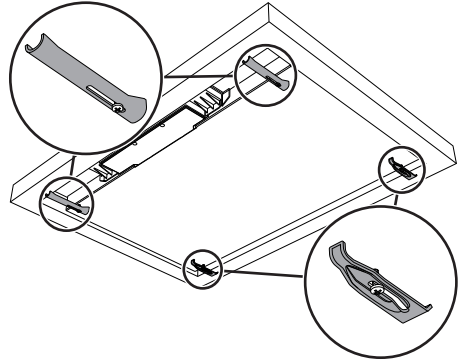

If tightened too much the glass may be strained and crack.



Installation

5.3 Mounting

Over built-in oven unit

The clearance between the hob and the kitchen units or other built-in appliances must be enough to ensure sufficient ventilation and air discharge.

If installed above an oven, a space must be left between the bottom of the hob and the top of the appliance installed below.

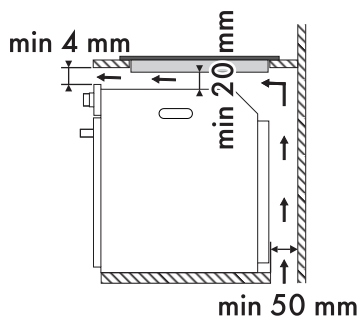

On top of an empty kitchen unit or drawers

If there are other pieces of furniture (lateral walls, drawers, etc.), dishwashers or fridges under the hob, a double-layer wooden base must be installed at least **20 mm** from the bottom of the hob to avoid any accidental contact. It must only be possible to remove the double-layer base using suitable equipment.

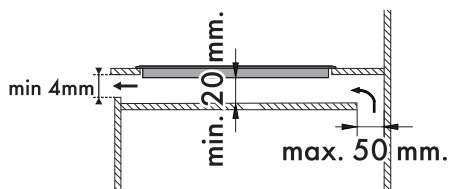
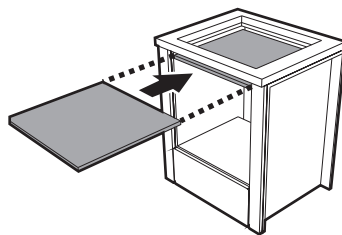

opens on bottom

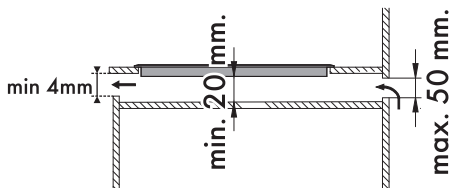

opens on rear



If installed on top of an oven, the latter must be equipped with a cooling fan.



Failure to install the double-layer wooden base exposes the user to possible accidental contact with sharp or hot parts.



5.4 Electrical connection



**Power voltage
Danger of electrocution**

- Have the electrical connection performed by authorised technical personnel.
- Use personal protective equipment.
- The appliance must be connected to earth in compliance with electrical system safety standards.
- Disconnect the mains supply.
- Do not pull the cable to unplug the appliance.
- Use cables withstanding a temperature of at least 90°C.
- The tightening torque of the screws of the terminal supply wires must be 1.5 - 2 Nm.

General information

Check the grid characteristics against the data indicated on the plate.

The identification plate bearing the technical data, serial number and brand name is visibly positioned on the appliance.

Do not remove this plate for any reason.

Perform the ground connection using a wire that is 20 mm longer than the other wires.

The appliance can work in the following modes:

- **220-240 V 2~**

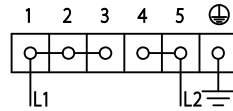

3 x 6 mm² three-core cable.

- **220-240 V 3~**

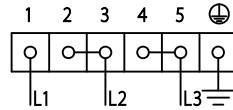

4 x 1.5 mm² four-core cable.

- **220-240 V 1N~**

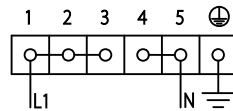

3 x 6 mm² three-core cable.

- **380-415 V 2N~**

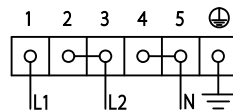

4 x 1.5 mm² four-core cable.

- **380-415 V 3N~**

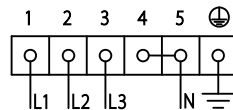

5 x 1.5 mm² five-core cable.



Installation

The diagram below illustrates the power supply terminal from below, with no cables connected. Terminals **4** and **5** must be connected at all times.

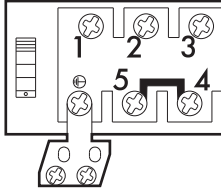

Connection with plug and socket

Make sure that the plug and socket are of the same type.

Avoid using adapters and shunts as these could cause overheating and a risk of burns.



Run the power cable in the rear part of the unit. Make sure that it does not come into contact with the lower part of the hob or a built-in oven below it.



Be careful when connecting additional electrical appliances. Connection cables must not come into contact with hot cooking zones.

Fixed connection

Fit the power line with an all-pole circuit breaker with a contact separation distance sufficient to provide complete disconnection in category III overvoltage conditions, pursuant to installation regulations.

Testing

At the end of installation, carry out a brief inspection test. If the hob fails to operate, after checking that you have carried out the instructions correctly, unplug the appliance and contact Technical Support.

5.5 Instructions for the installer

- The plug must be accessible after installation. Do not bend or trap the power cable.
- The appliance must be installed according to the installation diagrams.
- If the appliance does not work correctly after having carried out all the checks, contact your local Authorised Service Centre.
- Once the appliance has been installed, please explain to the user how to use it correctly.