

INSTRUCTIONS FOR USE

BEFORE USING THE APPLIANCE

SAFEGUARDING THE ENVIRONMENT

**PRECAUTIONS AND GENERAL
RECOMMENDATIONS**

PRODUCT DESCRIPTION

CONTROLS

**HOW TO OPERATE THE REFRIGERATOR
COMPARTMENT**

HOW TO USE THE FREEZER COMPARTMENT

HOW TO DEFROST THE APPLIANCE

CARE AND MAINTENANCE

**TROUBLESHOOTING GUIDE / AFTER-SALES
SERVICE**

AFTER-SALES SERVICE

INSTALLATION

ELECTRICAL CONNECTION

BEFORE USING THE APPLIANCE

- Your new appliance is designed exclusively for domestic use.

To ensure best use of your appliance, carefully read the operating instructions which contain a description of the appliance and advice on storing and preserving food.

Keep this handbook for future reference.

1. After unpacking the appliance, make sure it is not damaged and that the door closes properly. Any damage must be reported to the dealer within 24 hours of delivery of the appliance.
2. Wait at least two hours before switching the appliance on, in order to ensure that the refrigerant circuit is fully efficient.
3. Make sure installation and the electrical connection are carried out by a qualified technician according to the manufacturer's instructions and in compliance with the local safety regulations.
4. Clean the inside of the appliance before using it.

SAFEGUARDING THE ENVIRONMENT

1. Packing

The packing material is 100% recyclable and bears the recycling symbol. Comply with the local regulations for disposal. Keep the packing materials (plastic bags, polystyrene parts, etc.) out of the reach of children, as they are a potential source of danger.

2. Scrapping/Disposal

The appliance is manufactured using recyclable material.

This appliance is marked in compliance with European Directive 2002/96/EC on Waste Electrical and Electronic Equipment (WEEE).

By ensuring the correct scrapping of this appliance, you can help prevent potentially negative consequences for the environment and the health of persons.

The symbol  on the appliance, or on the accompanying documents, indicates that this appliance should not be treated as domestic waste but must be taken to a suitable collection centre for the recycling of electrical and electronic equipment. When scrapping the appliance, make it unusable by cutting off the power cable and removing the doors and shelves so that children cannot easily climb inside.

Scrap the appliance in compliance with local regulations on waste disposal, taking it to a special collection centre; do not leave the appliance unattended even for a few days, since it is a potential source of danger for children. For further information on the treatment, recovery and recycling of this appliance, contact your competent local office, the household waste collection service or the shop where you purchased the appliance.

Information:

This appliance does not contain CFC (the refrigerant circuit contains R134a) or HFC (the refrigerant circuit contains R600a) (refer to the rating plate inside the appliance).

Appliances with isobutane (R600a): Isobutane is a natural gas without environmental impact but is flammable. Therefore, make sure the refrigerant circuit pipes are not damaged

Declaration of conformity

- This appliance is intended for storing food and is manufactured in conformity with European regulation (EC) No. 1935/2004.



- This product has been designed, manufactured and marketed in compliance with:
 - the safety objectives of Low Voltage Directive 73/23/EEC;
 - the protection requirements of "EMC" Directive 89/336/EEC, amended by Directive 93/68/EEC.
- Electrical safety of the appliance is guaranteed only if it is connected to an efficient and approved earthing system.

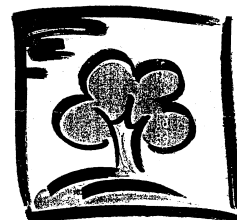

PRECAUTIONS AND GENERAL RECOMMENDATIONS

- During installation, make sure the appliance does not damage the power cable.
- Make sure the appliance is not near a heat source.
- To guarantee adequate ventilation, leave a space on both sides and above the appliance and follow the installation instructions.
- Keep the appliance ventilation openings free.
- Power cable modification or replacement must only be carried out by qualified personnel.
- It must be possible to disconnect the appliance from the power supply by unplugging it or by means of a mains two-pole switch installed upstream of the socket.
- Make sure the voltage indicated on the appliance rating plate corresponds to that of your home.
- For the water connection, use the pipe supplied with the new appliance; do not reuse that of the previous appliance.
- Install and level the appliance on a floor strong enough to take its weight and in a place suitable for its size and use.
- The appliance must be handled and installed by two or more persons.
- Be careful not to damage the floors when moving the appliance (e.g. parquet).
- Do not use single/multi-adapters or extension cords.
- Install the appliance in a dry and well-ventilated place. The appliance is arranged for operation in places where the temperature comes within the following ranges, according to the climatic class given on the rating plate. The appliance may not work properly if it is left for a long period at a temperature outside the specified range.
- Do not store or use petrol, gas or flammable liquids in the vicinity of this or other electrical appliances. The fumes can cause fires or explosions.
- Do not use mechanical, electric or chemical means other than those recommended by the Manufacturer to speed up the defrost process.
- Do not damage the appliance refrigerant circuit pipes.
- Do not use or place electrical appliances inside the product if they are not of the type expressly authorised by the Manufacturer.
- This appliance is not designed for use by young children or the infirm without supervision.
- To avoid the risk of children becoming trapped and suffocating, do not allow them to play or hide inside the appliance.
- Do not swallow the contents (non-toxic) of the ice packs (if provided).
- Use the refrigerator compartment only for storing fresh food and the freezer compartment only for storing frozen food, freezing fresh food and making ice cubes.
- Do not store liquids in glass containers in the freezer compartment since they may burst.
- Do not eat ice cubes or ice lollies immediately after taking them out of the freezer since they may cause cold burns.
- Before carrying out any maintenance or cleaning operation, unplug the appliance or disconnect the power supply.
- All appliances equipped with an ice-maker and water dispenser must be connected to a water supply that delivers drinking water only (with mains water pressure of between 0.17 and 0.81 Mpascals (1.7 and 8.1 bar)). Ice-makers and/or water dispensers not directly connected to the water supply must be filled with drinking water only.

Climatic Class	Amb. T. (°C)	Amb. T. (°F)
SN	From 10 to 32	From 50 to 90
N	From 16 to 32	From 61 to 90
ST	From 16 to 38	From 61 to 100
T	From 16 to 43	From 61 to 110

• **The Manufacturer declines any liability if the above advice and precautions are not respected.**

PRODUCT DESCRIPTION

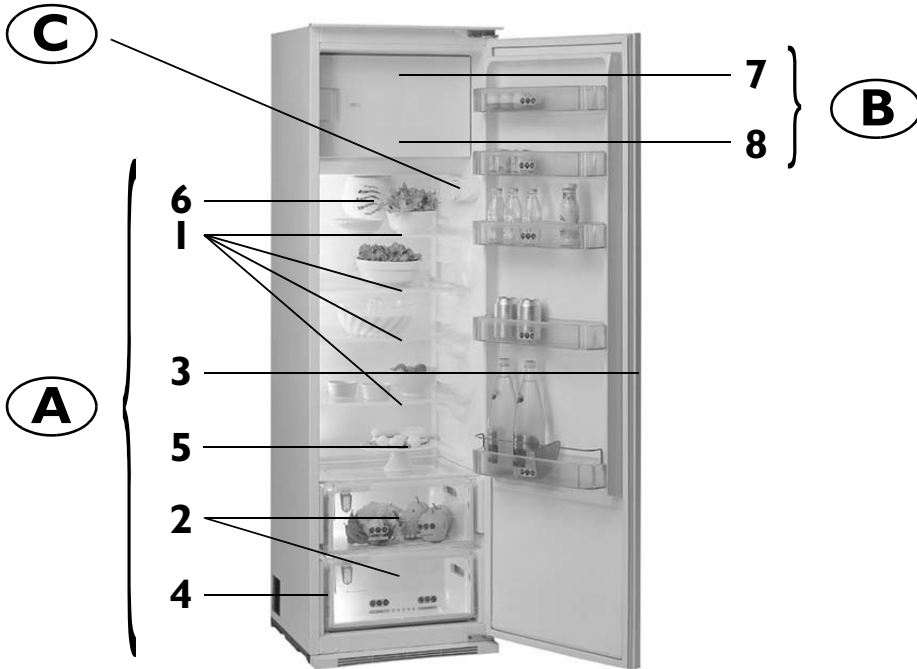

A) Refrigerator compartment

(for storage of fresh food and beverages)

1. Shelves (partly height adjustable)
2. Fruit and vegetable drawer with moisture control (if provided)
3. Refrigerator inner door
4. Rating plate (at the side of crisper drawer)
5. Defrost water drain
6. Fan (if provided)

B) Freezer compartment (if supplied)

(marked with symbol  for storing fresh food, frozen food and making ice cubes)

7. Grid (inside the compartment)
8. Ice cube tray (inside the compartment)

C) Controls

CONTROLS

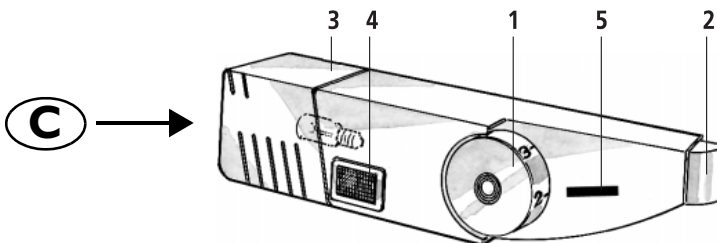

1. Thermostat
2. Light switch
3. Bulb cover
4. Fast freeze button with LED: Press this button (if provided) when the ambient temperature is below 16°C and/or 12 hours before placing food in the freezer (see instructions for use).

5. Reference scale

Switch off the button after use.

HOW TO OPERATE THE REFRIGERATOR COMPARTMENT

This appliance is a refrigerator with a ******* star freezer compartment.

Optimal appliance performance is obtained at ambient temperatures between **+10° C** and **+38° C**.

Switching on the appliance

Once the power plug is inserted in the mains socket, unless the thermostat is set to symbol **●** the inside light switches on each time the door is opened.

Once the temperature has been set – see next chapter – the appliance is ready for use.

To adjust the temperature:

- thermostat set to **●**: no refrigeration, no light.
- thermostat set to **1**: minimum refrigeration.
- thermostat set to **3-4**: medium refrigeration.
- thermostat set to **7**: maximum refrigeration.

Important

- To freeze food and/or when the ambient temperature is **below 16°C**, press the button **(4)**. The low temperature LED **(4)** lights up.
- Switch off the LED **(4)** as soon as the temperature returns **above 16°C**.
- Thermostat adjustment **(1)** will depend on where the appliance is installed, ambient temperature and frequency of door opening.

How to use the refrigerator compartment:

③ Position the food as illustrated in the figure:

1. Cooked food
2. Dairy products, preserves, cheese, butter
3. Fish, meat
4. Sliced cold meat
5. Fruit, vegetables, salad
6. Small jars, eggs
7. Tubes, small jars
8. Small bottles
9. Bottles



Note:

- Cover food to prevent it drying out.
- Hot food must be allowed to cool properly before being placed in the refrigerator.
- Make sure sufficient space is left for air to circulate around the food.

Defrosting of the refrigerator compartment is completely automatic.

Fan

The fan operates automatically.

The fan gives more even temperature distribution inside the refrigerator compartment, thus allowing better conservation of stored food and reduction of excess moisture.

Do not obstruct the fan intake zone with foods.

HOW TO USE THE FREEZER COMPARTMENT

The freezer compartment **✳️❄️❄️** can be used for freezing fresh food.

The quantity of fresh food that can be frozen in 24 hours is shown on the rating plate.

Freezing fresh food:

- Press the freeze button (4) 12 hours before placing food in the freezer. The freeze function LED (4) lights up.
 - Set the thermostat (1) to 3-4.
 - If your appliance is equipped with a grid, position food to be frozen as indicated in **Fig. 1**, otherwise position food as illustrated in **Fig. 2**.
- A** Arrange the fresh food on the grid, leaving sufficient space around each pack for the air to circulate and avoiding contact with already frozen food (**Fig. 1**).
- B** Arrange the food centrally in the compartment **✳️❄️❄️**, ensuring it does not come into contact with already frozen food. Leave a space of approx. 20 mm around packages (**Fig. 2**).
- After 24 hours press the button (4) to switch off. Reset the thermostat (1) to the normal position.

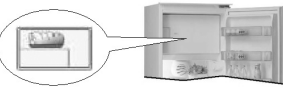
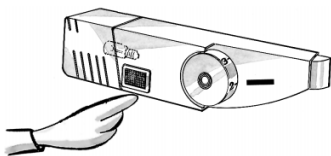

Fig. 1



Fig. 2

When purchasing frozen food products:

- Ensure that the packaging is not damaged (frozen food in damaged packaging may have deteriorated). If the package is swollen or has damp patches, it may not have been stored under optimal conditions and defrosting may have already begun.
- When shopping, leave frozen food purchases until last and transport the products in a thermally insulated cool bag.
- Place the items in the compartment as soon as you get home.
- If food has defrosted even partially, do not re-freeze it. Consume within 24 hours.
- Avoid, or reduce temperature variations to the minimum. Respect the best-before date on the package.
- Always observe the storage information on the package.

Making ice cubes

- Fill the ice cube tray 2/3 full and place it in the compartment **✳️❄️❄️**.
- Do not use sharp or pointed instruments to detach the tray if it is stuck to the freezer bottom **✳️❄️❄️**.
- Bend the ice tray slightly to remove the cubes.

The table alongside shows the recommended maximum storage time for frozen fresh foods.

MONTHS	FOOD		
1-3			
4-7			
8-12			

HOW TO DEFROST THE APPLIANCE

Before defrosting, unplug the appliance from the mains or disconnect the electrical power supply. Defrosting of the refrigerator compartment is completely automatic. Droplets of water on the rear wall of the refrigerator compartment indicate that the periodic automatic defrost cycle is in progress. The defrost water is automatically routed to a drain outlet and into a container from which it evaporates.

Clean the defrost water drain outlet regularly using the tool supplied with the appliance in order to ensure defrost water is removed correctly.



Defrosting the compartment ❄️

Defrost the compartment ❄️ once or twice a year or when the ice formation is excessive.

It is perfectly normal for ice to form. The amount and speed at which the ice forms depends on ambient conditions and the frequency with which the door is opened. Ice formation is concentrated at the top of the compartment and does not affect the efficiency of the appliance.

If possible, defrost the freezer when it is nearly empty.

- To switch off the freezer compartment, set the thermostat to ●.
- Remove the food from the freezer compartment and group together in a cool place or in a cool bag.
- Leave the door open to allow the frost to melt.
- Clean the interior with a sponge soaked in warm water and/or neutral detergent. Do not use abrasive substances.
- Rinse the interior and dry thoroughly.
- Put the food back into the freezer.
- Close the door.

Plug in the appliance again and switch on following the instructions in chapter “How to operate the refrigerator compartment”: Adjustments and selections valid before switching off will automatically be restored.

CARE AND MAINTENANCE

Before any cleaning or maintenance operation, unplug the appliance or disconnect it from the power supply.

- Periodically clean the refrigerator compartment with a sponge moistened with lukewarm water and/or neutral detergent. Rinse and dry with a soft cloth.
Do not use abrasive products.
- The separators must be cleaned with a damp sponge and not placed in water.
- Clean the inside of the freezer compartment during defrosting.
- Periodically clean the ventilation grilles and the condenser at the rear of the appliance with a vacuum cleaner or a brush.
- Clean the outside with a soft cloth moistened with water.
Do not use abrasive pastes, scouring pads, stain-removers (e.g. trichloroethylene, acetone) or vinegar.

Long vacation

1. Empty the refrigerator completely.
2. Disconnect the appliance from the power supply.
3. Defrost and clean the inside.
4. If the appliance is not used for a long time, the door must remain open to prevent the formation of mould, unpleasant odours and oxidation.
5. Clean the appliance.
 - Clean the inside of the low temperature compartment (in models where available) during defrosting.
 - Periodically clean the inside of the refrigerator compartment with a sponge moistened with lukewarm water and/or neutral detergent. Rinse and dry with a soft cloth. Do not use abrasive products.
6. Clean the outside with a moistened cloth. Do not use abrasive pastes, scouring pads, stain-removers (e.g. acetone, trichloroethylene) or vinegar.

Lamp replacement:

When replacing the lamp, proceed as follows:

- Unplug the appliance from the power supply
- Press the top part of the lamp.
- Remove the lamp cover.
- Replace the lamp with one of the same power or of the max. power in watt, specified near the lamp holder.
- Refit the lamp cover and wait 5 minutes before reconnecting the appliance.

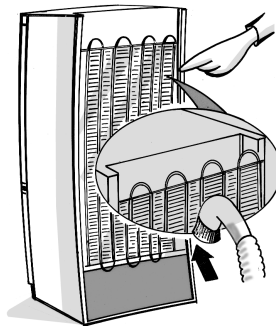

TROUBLESHOOTING GUIDE / AFTER-SALES SERVICE

When you hear these noises

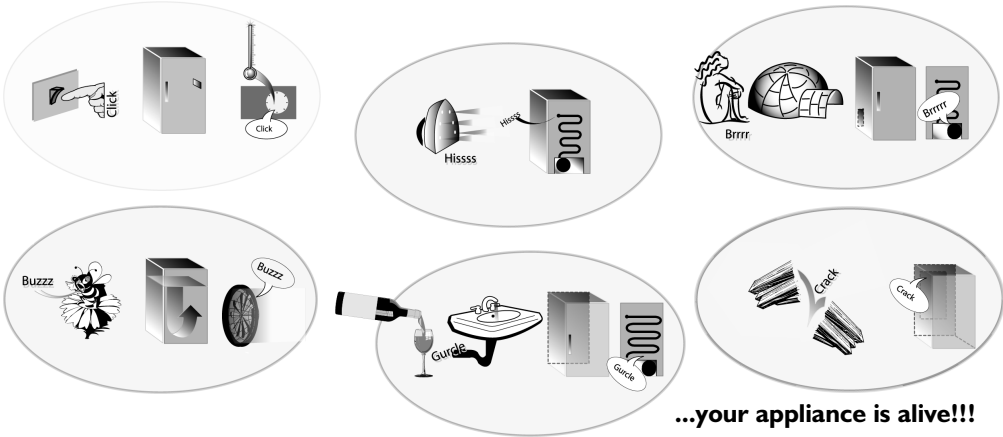

...your appliance is alive!!!

1. Temperature inside the compartments is not low enough.

- Is food preventing the doors from closing properly?
- Is the thermostat setting correct?
- Are the air circulation vents blocked?

2. Temperature inside the refrigerator compartment is too low.

- Is the thermostat setting correct?

3. The appliance is excessively noisy.

- Has the appliance been installed correctly?
- Are the pipes at the back touching or vibrating?
- It is normal to hear the noise of the refrigerant liquid in circulation.

4. The appliance is not working?

- Is there a power failure?
- Is the plug properly inserted in the socket?
- Do the household electrical system protection devices work correctly?
- Is the power cord damaged?

5. Water collects at the bottom of the refrigerator compartment.

- Is the thermostat setting correct?
- Is the defrost water drain blocked?

6. The inside light is not working. ⑦ Perform the checks for point 4, and then:

- Disconnect the appliance from the mains power supply.
- Replace the lamp with one of the same power or of the max. power in watt, specified near the lamp holder.

AFTER-SALES SERVICE

Before contacting After-Sales Service:

1. See if you can solve the problem yourself with the help of the Trouble-shooting guide.
2. Switch the appliance on again to see if the problem has been solved. If it has not, disconnect the appliance from the power supply and wait for about an hour before switching on again.
3. If the problem persists after this course of action, contact After-sales Service.

Specify:

- the nature of the problem
- the model
- the Service number (the number after the word SERVICE on the rating plate on the inside of the appliance)
- your full address
- your telephone number and area code

SERVICE 0000 000 00000



Note:

The direction of door opening can be changed. If this operation is performed by After-sales Service it is not covered by the warranty.

INSTALLATION

- Install the appliance away from heat sources. Installation in a hot environment, direct exposure to the sun or installation near heat sources (heaters, radiators, cookers) will increase power consumption and should therefore be avoided.
- If this is not possible, the following minimum distances must be respected:
 - 30 cm from coal or paraffin stoves;
 - 3 cm from electric and/or gas stoves.
- Fit the spacers (if supplied) on the rear of the condenser positioned at the back of the appliance.
- Install the appliance in a dry, well-ventilated place, and ensure it is level, using the front adjustment feet if necessary.
- Clean the interior.
- Fit the accessories.

Electrical connection

- **Electrical connections must be made in accordance with local regulations.**
- Voltage and power consumption are indicated on the rating plate inside the appliance.
- **Regulations require that the appliance is earthed.**
The Manufacturer declines all liabilities for injury to persons or animals or damage to property resulting from failure to observe these regulations.
- If the plug and socket are not of the same type, have the socket replaced by a qualified electrician.
- Do not use extension leads or adapters.

Disconnecting the appliance

It must be possible to disconnect the appliance by unplugging it or by means of a two-pole switch fitted upline of the socket.

ELECTRICAL CONNECTION

1) For Great Britain only

Warning - this appliance must be earthed

Fuse replacement

If the mains lead of this appliance is fitted with a BS 1363A 13amp fused plug, to change a fuse in this type of plug use an A.S.T.A. approved fuse to BS 1362 type and proceed as follows:

1. Remove the fuse cover (A) and fuse (B).
2. Fit replacement 13A fuse into fuse cover.
3. Refit both into plug.

Important:

The fuse cover must be refitted when changing a fuse and if the fuse cover is lost the plug must not be used until a correct replacement is fitted.

Correct replacement are identified by the colour insert or the colour embossed in words on the base of the plug.

Replacement fuse covers are available from your local electrical store.

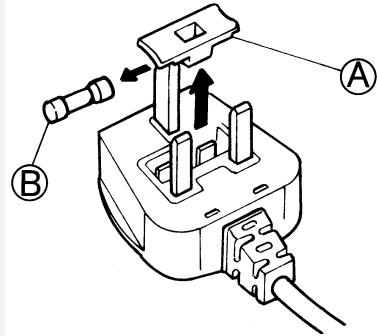

2) For the Republic of Ireland only

The information given in respect of Great Britain will frequently apply, but a third type of plug and socket is also used, the 2-pin, side earth type.

3) Socket outlet / plug (valid for both countries)

If the fitted plug is not suitable for your socket outlet, please contact Whirlpool Service for further instruction. Please do not attempt to change plug yourself. This procedure needs to be carried out by a qualified Whirlpool technician in compliance with the manufactures instructions and current standard safety regulations.