





**LAVATRICE
WASHING MACHINE
LAVE-LINGE
WASCHVOLLAUTOMAT
LAVADORA**

 LIBRETTO ISTRUZIONI	IT
 INSTRUCTION MANUAL	EN
 MANUEL D'INSTRUCTIONS	FR
 GEBRAUCHSANLEITUNG	DE
 MANUAL DE INSTRUCCIONES	ES

Contents

1. Precautions for safety and use	2
2. Installation instructions	5
3. Description of controls	8
4. Using the appliance for washing	9
5. Cleaning and maintenance	16
6. Troubleshooting	18



This appliance is tagged  in accordance with European Directive 2002/96/EC on Waste Electrical and Electronic Equipment - WEEE.

This directive contains the regulations governing the collection and recycling of decommissioned appliances throughout the European Union.

The symbol of the rubbish bin with a line through it on the appliance or its packaging indicates that the product must be disposed of separately from other waste at the end of its life cycle. The user is thus obliged to consign scrapped appliances to the special electronic and electrotechnical waste disposal centres, or return them to the dealer on purchase of a similar new appliance, on a one-to-one basis.

Consignment to the appropriate facility for environmentally responsible recycling, treatment and disposal helps to prevent any negative effects on the environment and health, and encourages the reuse and/or recycling of the appliance's component materials.

Illegal dumping of the appliance by the user will be subject to prosecution under the relevant law.

**READ THE INSTRUCTIONS****Attention!**

You are advised to read all the instructions in this manual carefully; it will inform you about the right conditions for the proper, safe use of your washing machine. It is very important to keep this instruction manual with the appliance for future reference.

In the event of sale or transfer, ensure that the manual always accompanies the appliance, to provide the necessary information about its use.

1. PRECAUTIONS FOR SAFETY AND USE**Attention!**

These precautions are detailed for reasons of safety.

This section must be read carefully before installation and use.

Disposing of packaging

- Never leave packaging residues unattended in the home. Separate waste packaging materials by type and consign them to the nearest recycling centre.
- Packaging materials (plastic bags, polystyrene, etc.) must not be left within reach of children.

Disposing of old appliances

- **Once no longer in use, the appliance must be rendered unusable: permanently disarm the lock on the door (this will prevent children risking their lives by locking themselves inside during play) and cut the power supply lead after removing the plug from the socket. The appliance must be delivered to a recycling facility.**

Environmental protection

- Use the whole of the maximum recommended capacity. Never exceed the maximum permitted load.
- Do not use the prewash function for lightly or normally soiled items.
- Follow the manufacturer's recommendations on detergent usage.
- Use the highest spin speed permitted for the fabric type. Fast spins reduce the drying time and thus energy consumption.

Safety instructions

- This appliance is intended for domestic use and is compliant with Directives 72/23/EEC and 89/336/EEC (including Directives 92/31/EEC and 93/68/EEC) currently in force.
- Read all the instructions in this manual carefully before installation and use.
- Check that the drum assembly has been released before use (see instructions). Failure to release the drum assembly may cause damage to the washing machine and the surrounding furniture or appliances during the spin cycle.
- This Instruction Manual is an integral part of the appliance: it must always be kept intact with the appliance. Installation must be carried out by qualified staff in compliance with the relevant regulations. The appliance is built to provide the following functions: washing and drying of clothes or fabrics stated to be suitable for machine washing by the producer on the relevant label. All other uses are to be considered improper. **The manufacturer declines all liability for uses other than those stated above.**
- The nameplate with the technical data, serial number and mark is in a visible position in the part in view after the door has been opened. **The nameplate must never be removed.**
- **The electrical and plumbing works required to install the appliance must only be carried out by skilled staff.**
- The appliance must be connected to earth in compliance with electrical system safety regulations. **The manufacturer declines all liability for direct or indirect injury or damage deriving from a non-existent or defective earth connection.**
- In the event that the appliance is not connected by means of a plug, an omnipolar circuit-breaker device with contact gap of at least 3 mm must be provided.
- The plug to be connected to the power supply lead and the relative socket must be of the same type and comply with the relevant regulations. Check that the mains voltage and frequency are the

same as the values marked on the nameplate. The use of adapters or junctions is not recommended. Never disconnect the plug by pulling on the power supply lead.

- **The appliance is only disconnected from the electricity supply if the plug has been removed from the socket or the electrical system master switch has been turned off. The power plug must be accessible after the appliance has been installed.**
- The appliance must be installed using new sets of hoses (supplied with the appliance). Old hose sets should not be reused.
- Take care that the appliance is not standing on the power supply cable.
- The washing machine must never be used on vehicles, on board ships or planes, or in environments with hazards, such as explosive or corrosive environments (powders, vapours and gases) or explosive and/or corrosive liquids.
- Do not install the washing machine in places with a risk of frost. Frozen pipes may burst under the pressure.
- Make sure that the drain hose connected to the sink **is securely fastened and cannot move.**
- If it is not fixed in place, the repulsive force of the water might thrust it away from the sink, causing the **risk of flooding.**
- When connecting the hose to a sink **also check that the water drains from it quickly, as otherwise the sink may overflow.**
- Do not overload the appliance.
- Never use detergents which contain solvents or chemicals for washing in the washing machine. **They might damage the appliance and form poisonous vapours. These fumes might also catch fire and explode.**
- Garments soaked in petroleum products must not be washed in the washing machine. Before washing, check that garments do not contain inflammable devices (e.g. cigarette-lighters, matches, etc.)
- If volatile cleaning fluids are used, ensure that these substances have been removed from the garments before they are placed in the appliance.
- Before loading garments for washing, check that the pockets are empty, buttons secure and zips fastened.
- Do not wash frayed or torn garments.
- During washing at high temperatures, the glass in the door will become very hot.
- **Check that all water has been drained from the appliance before opening the door.**
- If there is water inside, pump it out before opening the door. If in doubt, read the instruction manual.
- **The water in the appliance is not suitable for drinking!**
- Swallowing washing machine detergents may injure the mouth and throat.
- Before removing the garments from the washing machine **check that the drum is at a standstill.**
- Switch the appliance off after each use to avoid wasting electricity.
- Leave the door ajar between washes to keep the gasket in good condition.
- In the event of a malfunction **never attempt to repair the appliance yourself.** Disconnect the appliance from the electricity supply and turn off the water tap. Then contact a qualified engineer. **Repairs must only be carried out by qualified staff.**
- **The appliance is intended for use by adults.** Do not allow children to tamper with the washing machine's controls or play with it and **do not keep children in the vicinity while the programme is in progress.**
- Young animals or small children might climb into the washing machine.
- Always check the inside of the drum before use and **do not allow children to play with the appliance.**
- Keep children away from the appliance when the door or the detergent drawer is open; the appliance might contain detergent residues which may cause permanent injury to the eyes, mouth and throat, or even cause death by suffocation.
- The appliance is not intended for use by persons (including children) with reduced physical, sensory or mental capabilities, or lack of experience and knowledge, unless they have been given supervision or instruction concerning use of the appliance by a person responsible for their safety.
- Do not store flammable fluids near the appliance.

Length periods out of use.

- If the appliance is not to be used for a lengthy period it should be disconnected from the electricity and water supplies and the door should be left ajar to prevent unpleasant smells from building up inside.

For Great Britain only

Warning: this appliance must be earthed.

Fuse replacement

If the mains lead of this appliance is fitted with a **BS 1363A 13amp** fused plug, to change a fuse in this type of plug use an **A.S.T.A.** approved fuse to **BS 1362** type and proceed as follows:

1. Remove the fuse cover (**A**) and fuse (**B**)
2. Fit replacement 13A fuse into fuse cover
3. Refit both into plug

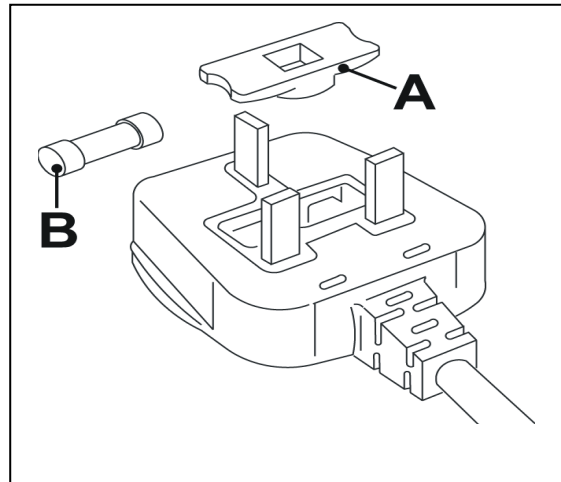

Important:

The fuse cover must be refitted when changing a fuse and if the fuse cover is lost the plug must not be used until a correct replacement is fitted.

Correct replacement are identified by the colour insert or the colour embossed in words on the base of the plug.

Replacement fuse covers are available from your local electrical store.

If the appliance is provided with a plugless supply cord:

- It is necessary to install in the fixed wiring an all-pole disconnection device having a gap between contacts of at least 3,5mm. After installation the disconnection device has to be easy to reach.
- The connection to the mains must be carried out by a qualified technician in accordance to the scheme shown below and the regulations in force

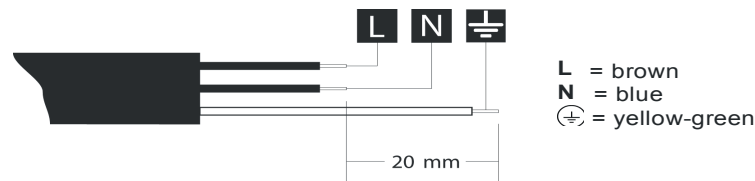

- In the event of damage to the supply cord, it has to be replaced by the manufacturer or an authorized technical service center in order to avoid any risk.

Important!

This appliance is easy to use.

However, for the best results it is important to read this manual carefully and follow all the instructions before putting it into operation.

The manual provides the correct instructions for installation, use and maintenance, as well as giving useful advice.

The manufacturer declines all responsibility for injury or damage caused by failure to comply with the above regulations or deriving from tampering with even just one part of the appliance and the use of non-original spare parts.

2. INSTALLATION INSTRUCTIONS

Important!

The appliance must be installed by a qualified engineer in compliance with the relevant regulations.
The washing machine is heavy. Take care when lifting it.

2.1 UNPACKING

The unit on flexible mounts is fixed in place for transport using the screws (A) on the rear of the washing machine with the relative plastic spacers (B). Once the screws have been removed, the power supply lead can be used.

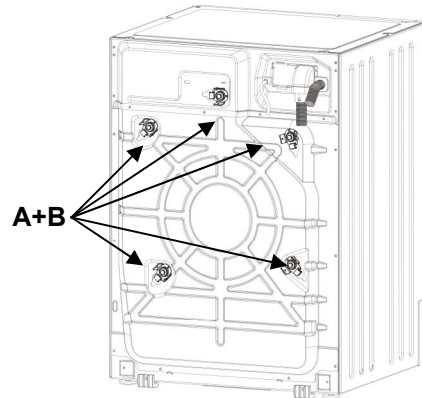

1. Undo **all** the screws with a 10 mm spanner.
2. Remove **all** the screws (A) from the rear
3. Remove **all** the plastic spacers (B)

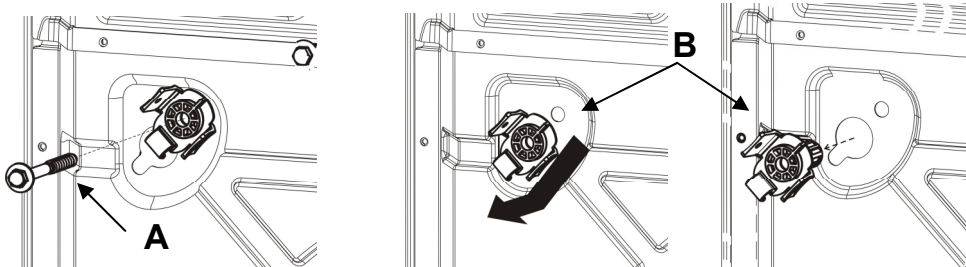

4. Fit **all** the plastic plugs (C) provided, to prevent water splashes from getting into the appliance, and contact with live parts.

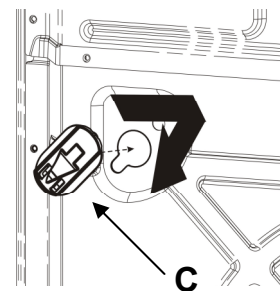
**Warning!**

- **Do not** turn the appliance upside-down or place it on its sides.
- All the transport retainer fittings should be kept in a safe place; they must be fitted again if the appliance has to be moved around in the future.

2.2 POSITIONING AND LEVELLING

1. Place the appliance in the chosen position.
2. Level the appliance carefully in all directions with the aid of a spirit level, adjusting the height of the feet if necessary. Once done, fix the feet in place with the locknuts provided.

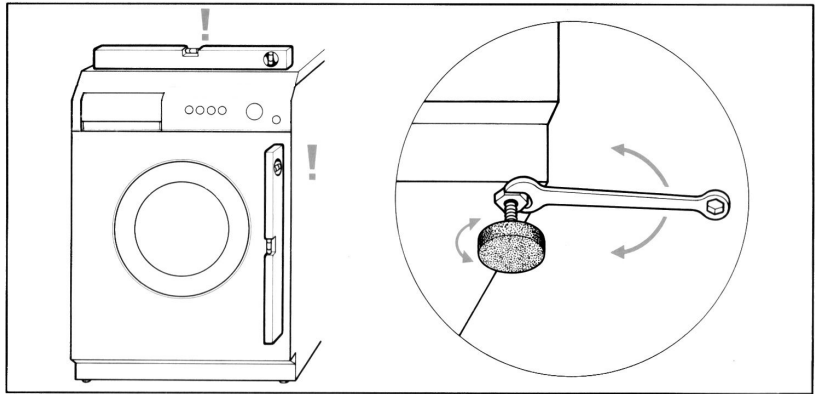

3. On appliances with **adjustable rear feet**, note that the rear of the appliance rests on skids and not on the feet. Before inserting the appliance into its place between the kitchen units, check that the rear feet are screwed fully in to prevent damage as the appliance is shifted into position.

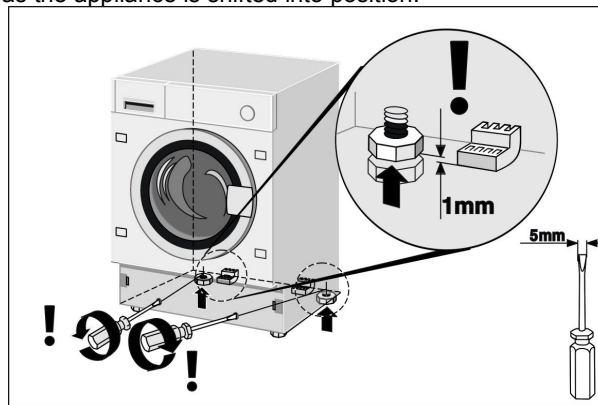

Once the appliance is in position in the kitchen, the height of the rear feet has to be increased so that the appliance no longer stands on the skids. After adjusting the rear feet, level the appliance and fix the front feet at the height required.

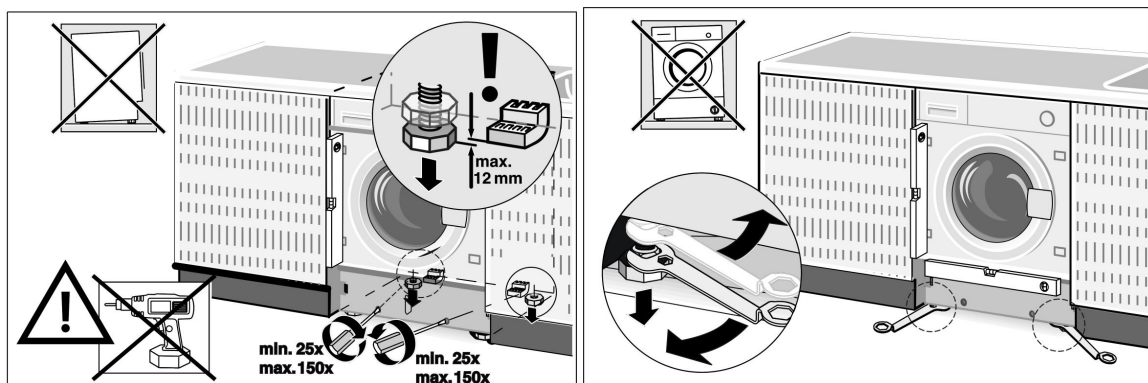

The water intake and drain hoses can be fitted pointing to the left or right for effective installation.

Warning!

- This operation must be carried out with care to prevent the washing machine from vibrating, moving or generating excessive noise during use.
- If the appliance is installed on a carpeted floor, take care to ensure that the openings in the bottom of the washing machine are not obstructed.
- Also check that during operation the washing machine is not resting against walls, kitchen units, etc.
- The appliance must not be installed behind a door with lock, a sliding door, or a door with hinge on the opposite side.

2.3 CONNECTING TO THE WATER SUPPLY

1. Check that the water supply pressure is in the following range: **0,05-0,9MPa**. With higher pressures, use a pressure reducer.
2. Connect the **cold water** supply hose (**blue** screw collar) to the cold water tap with $\frac{3}{4}$ gas threaded connector, taking care to tighten firmly to prevent leaks. The water supply hose must not be kinked or crushed and must not be changed or cut. Threaded connections must only be tightened by hand.
3. When appliances are supplied with **hot water**, the intake water temperature must not exceed 60°C and the hose with **red** screw collar must be connected to the hot water supply tap.

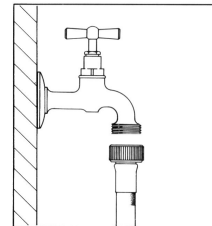

Warning!

- If the connection is made to new pipelines, or lines which have been out of use for a long time, allow a considerable amount of water to flow out before connecting the intake hose. This prevents any sand or other dirt from fouling the filters installed in the appliance to protect the water intake valves.
- The new intake hose supplied with the appliance must be used, and the old water supply hose must not be used.

2.4 CONNECTING TO THE DRAIN

1. Insert the end of the drain hose into a drain pipe having inside diameter of at least 4 cm, at least 50 to 90 cm above floor level, or connect it securely (using the plastic fitting on the elbow in the hose) to a sink or bathtub.

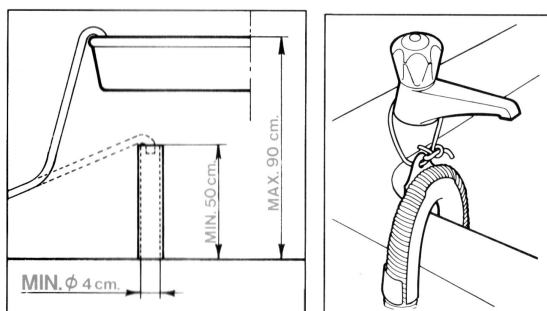

2. In all cases, check that the end of the drain hose is securely fixed to prevent the repulsive force of the water from pushing it out of place.

Warning!

- Avoid kinks or restrictions to ensure effective drainage.
- Any drain hose extensions must be no more than 1 metre long, must be of the same diameter and must be free from restrictions of all kinds.
- The end of the drain hose must never be submerged in water.

2.5 ELECTRICAL CONNECTION

Before connecting the plug to the power socket ensure that:

1. The electrical system voltage is the same as that stated on the nameplate on the front of the appliance, in the zone visible when the door is open. The rated power supply and the fuses required are specified on the nameplate.
2. The meter, safety breakers, power supply line and power socket are rated to withstand the maximum load required, stated on the nameplate.
3. The power supply socket and the plug fitted to the appliance are compatible without the use of reductions, multiple sockets, adapters and extension leads which might cause overheating or scorching. If the power supply socket is not compatible with the plug supplied, replace the socket with one of the appropriate type.

Warning

- The power plug must be accessible after the appliance has been installed.
- **It is absolutely essential to connect the appliance to earth.** Connect the plug to a socket with an earth connection in good working order.

The manufacturer declines all liability for direct or indirect injury or damage deriving from a non-existent or defective earth connection. Correct electrical connection guarantees conditions of maximum safety.

- This appliance is compliant with the requirements of EEC directive 89/336 of 3.5.89 (including the amendment directive 92/31/EEC) concerning the elimination of radio-frequency disturbance.

- If the power supply lead is damaged, it must only be replaced with an original spare, available from the After-Sales Service.
- **Do not connection/disconnect the power supply plug from the socket with wet hands**
- **Only disconnect the power supply plug from the socket by taking hold of the plug itself, never by pulling on the lead.**

3. DESCRIPTION OF CONTROLS

3.1 CONTROL PANEL

All the appliance's control and monitoring devices are placed together on the front panel.

Display: shows the settings (spin speed, cycle status, flexi time, child lock on/off, maximum recommended weight). The settings can be modified using the buttons underneath.

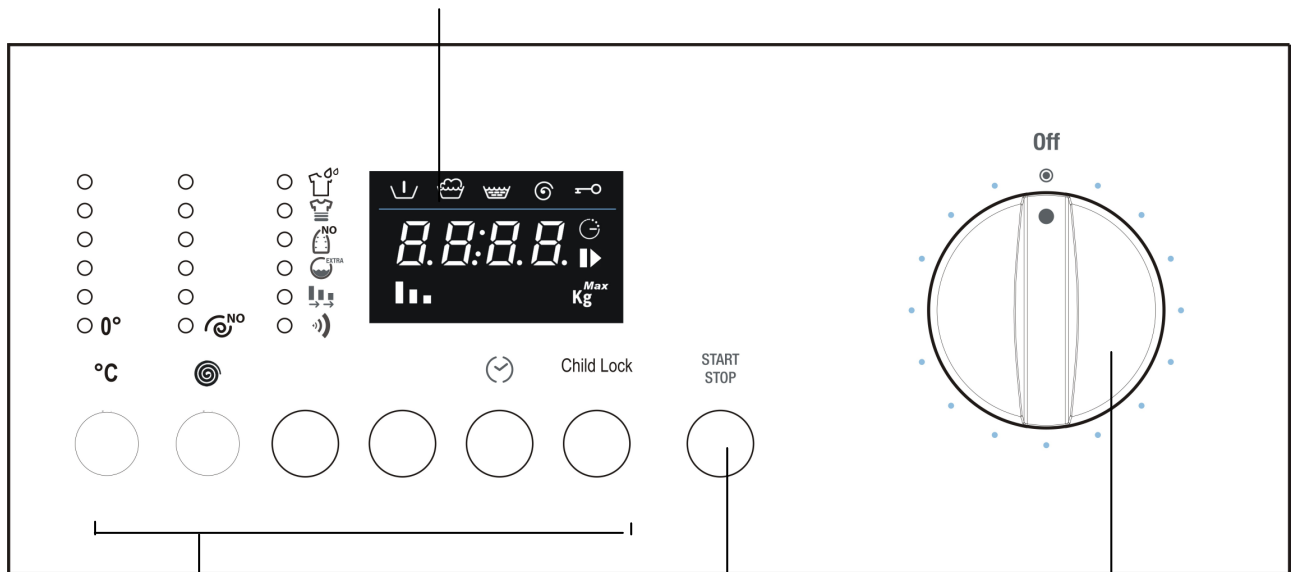

Buttons (from left to right):
Temperature selection
Spin speed selection
Option selection
Confirm option
Delay Timer
Child Lock

Start/Pause button:
 For starting and stopping working cycles.

Programme Selector
 For switching the washing machine on and off and selecting programmes. Can be turned in either direction. Does not turn while programmes are in progress.

4. USING THE APPLIANCE FOR WASHING

4.1 PREPARING THE ITEMS FOR WASHING

1. Subdivide the items for washing by fabric type and colour fastness.
2. Wash white and coloured items separately. New coloured items should be washed separately the first time. Normally, items carry labels with washing instructions. The following is a short description of the symbols used on these labels.

WASHING		BLEACHING			
	Machine wash at max. 90°C	 Bleaching allowed		 Do not bleach	
	Machine wash at max. 60°C				
		IRONING			
	Machine wash at max. 40°C	 Hot iron	 Warm iron	 Cool iron	 Do not iron
	Machine wash at max. 30°C				
		DRY CLEANING			
	Machine wash, delicate cycle at max. 60°C	 Any solvent	 Any solvent except trichloroethylene	 Petroleum solvent and R113	 Do not dry clean
	Machine wash, delicate cycle at max. 40°C				
	Machine wash, delicate cycle at max. 30°C				
		DRYING			
	Hand wash	 High temperature	 Less than 60°C	 Do not tumble dry	
	Do not wash				

Warning!

- Do not wash unhemmed or torn items as they may fray.
- Unrelated items in the wash may damage the garments or parts of the washing machine. So: empty pockets and turn them inside-out, and remove wheels from curtains or wrap them in a mesh bag.
- Wash very small items (belts, handkerchiefs, socks, padded bras, etc.) in a white canvas bag. Fasten press-studs and zips and sew on loose buttons.
- The use of modern detergents and the correct washing temperature is generally sufficient to remove stains from fabrics. However, some difficult stains such as grass, fruit, egg, blood, rust, ballpoint pen, etc. should be dealt with before washing. **Depending on the type of fabric, there are a large number of commercial stain removers on the market. In all cases, stains should be cleaned or diluted at once, since the older they are, the harder they are to remove.**
- **Failure to comply with washing guidance symbols may result in damage to the items washed.**

Wool – Only wool marked as pure new wool, with the mark, or labelled "shrink-proof, machine-washable" can be washed in a washing machine on the specific programme; other types of wool should be hand-washed or dry-cleaned.

4.2 OPENING THE DOOR

The appliance is fitted with a safety device which prevents the door from being opened while the programme is in progress.

1. **Check that all the water has been drained from the tank and the drum is at a standstill.**

Warning!

- If the washing programme is interrupted, it will be from 3 to 15 minutes before the door can be opened, depending on the temperature reached inside the appliance.

Warning!

The water may still be boiling hot if the wash was at high temperature. Do not open the door if there is still water in the drum!

4.3 LOADS OF WASHING

As far as possible, **to save electricity, it is more economical to wash complete loads of the various types of fabric.** Shake out the washing before loading, and alternate large and small items. It is best to weight the load the first few times, after which you will be able to rely on your experience. As a guide, the following is a list of the average weights of the standard items:

4.4 LOADING THE ITEMS FOR WASHING

1. Open the door and load the washing, distributing it evenly over the drum, with items opened out and not bundled together; if possible, large and small items should be well mixed.
2. The washing machine covered by this manual can be **loaded with up to 7kg** of washing for each wash. If this weight is exceeded, the washing results will be poor and the appliance may malfunction.
3. **To save energy it is more economical to wash full loads** of the various types of fabric, following the guidance on quantities provided in the "Programmes Table" supplied in this manual.
4. Close the door by pressing against the frame until you hear it click shut. Take care not to trap items of washing between the door and the rubber gasket.

Warning!

- If the door is not properly closed, a safety device prevents the washing machine from starting.
- **Do not exceed the maximum load: overloading adversely affects washing results.**

4.5 ADDING DETERGENT AND ADDITIVE

The internal tray comprises three compartments, marked with the symbols



prewash detergent



main wash detergent



for fabric conditioner, starch, additives, etc. (e.g. treatment products). The additives are added to the washing tank automatically during the final rinse.

The main wash detergent compartment has a tang allowing the use of liquid detergent. To insert it, pull it towards the front and then lower it.

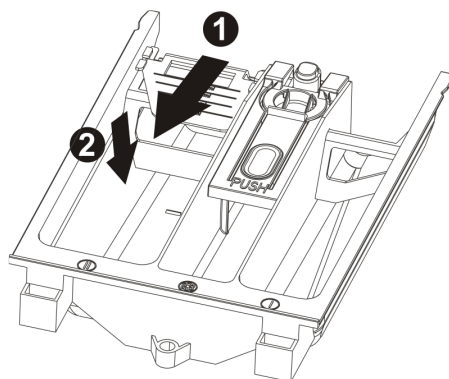

Following the recommendations in the "Programmes Table" supplied with this manual, place the detergent and any additives in the drawer before the start of the programme.

Never fill with liquids above the maximum level marked; otherwise the trays will empty too quickly.

Before pouring dense additives into the container, dilute with a little water to ensure they do not clog the outlet.

Use only low-foam detergents suitable for use in a washing machine.

The amount of detergent must be decided in relation of the hardness of the water, the type and quantity of items loaded, and their degree of dirt.

This will provide the desired effect with optimal detergent consumption.

tion.

On detergent packs the recommended dose is indicated for 4 levels of water hardness and for loads of 4-5 kg of washing with average dirt levels.

Request information about the water's hardness from your water supply company.

Water hardness

<i>Level of hardness</i>	<i>French degrees fH</i>	<i>German degrees dH</i>
Soft	Up to 15°	Up to 8°
Medium	15° - 25°	8° - 14°
Hard	25° - 40°	14° - 22°
Very hard	More than 40°	More than 22°

4.6 POWDER DETERGENT DOSES

Laundry with normal dirt

1. Choose a programme without prewash.
2. Pour the total amount of detergent shown on the pack into the main wash compartment of the detergent drawer.

Very dirty laundry

1. Choose a programme with prewash.
2. Place $\frac{1}{4}$ of the recommended amount of detergent in the prewash compartment of the detergent drawer and $\frac{3}{4}$ of the detergent in the wash compartment.

Warning!

- If no recommended doses are provided, for delicate items in synthetic fibre use from $\frac{1}{2}$ to $\frac{2}{3}$ of the recommended dose for washing tough cotton fabrics.
- Only neutral detergents recommended for wool should be used on the wool programme.
- Use the doses recommended by the detergent producer.

4.7 LIQUID DETERGENT DOSES

1. Pour the dose required into the measuring cap supplied with the bottle of liquid detergent and place it in the drum, or use the main wash compartment of the detergent drawer, fitting the insert provided.
2. The scale on the red insert is intended as an aid when deciding the dose of liquid detergent.

Warning!

- Liquid detergents can be used, at the doses recommended by the producer, **only for the main wash, i.e. in all programmes without prewash.**

4.8 DESCALERS

Descalers can be added to the prewash and main wash compartments as recommended by their producers. Place the detergent in the compartments first, followed by the descaler.

4.9 PROGRAMMES AND FUNCTIONS

For advice on selecting programmes in relation to the type of fabric, refer to the "Programmes Table", supplied with this manual.

4.10 SWITCHING ON THE APPLIANCE AND SELECTING THE WASHING PROGRAMME

To switch on the appliance and select the programme, proceed as follows:

1. Turn the programmes knob in either direction. This switches on the washing machine.
2. Select the washing programme. The time left to the end of the programme and the maximum recommended weight for the selected programme alternate on the display. The symbols on the display light up to identify the information shown.
3. The default spin speed values are shown. The initial settings can be modified using the button underneath the sequence of spin speeds. And temperatures
4. If spin speed  is set, there will be no spin cycle and the appliance will stop with the tank full. If this value is set the appliance does not perform the final spin and the washing programme ends with water in the tank.

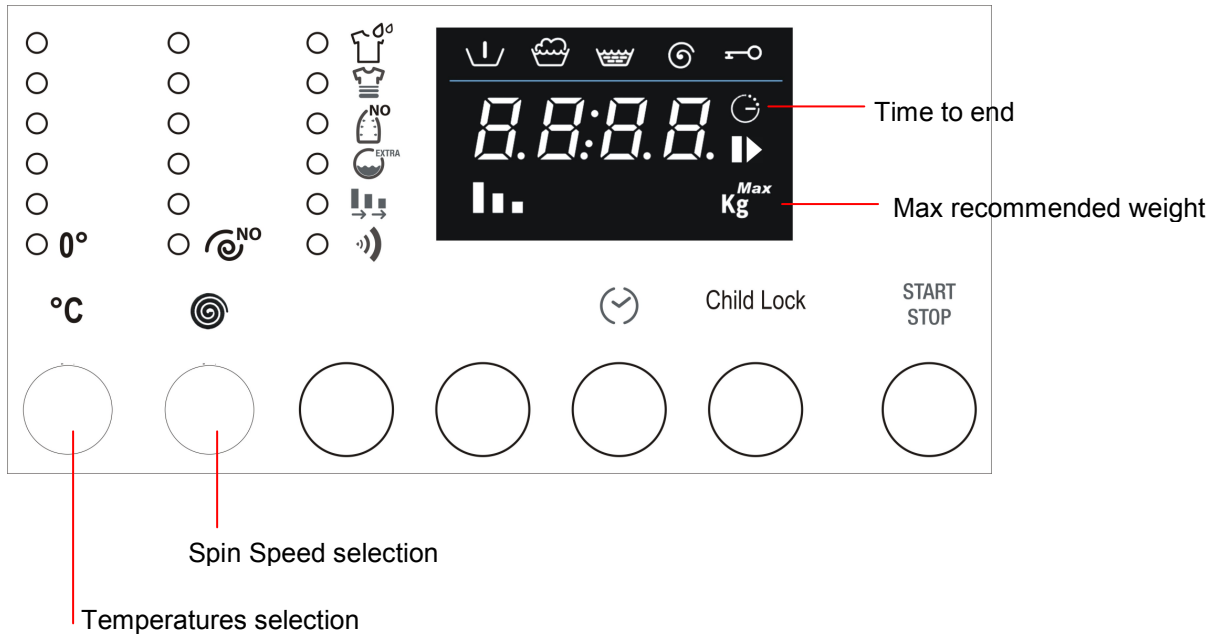

4.11 SELECTING AND CONFIRMING OPTIONS

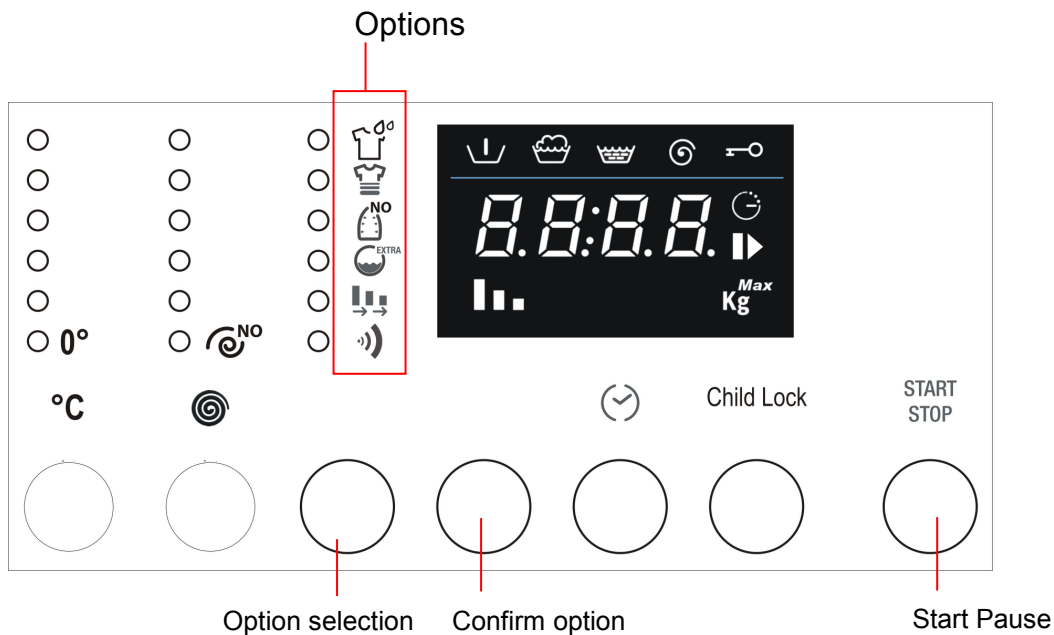

- The Option Selection button can be used to select the following options in sequence (from the top down):

 - Prewash:** adds a stage before the main wash, lasting about 20 minutes at a temperature of 35°C. Suitable for loads of particularly dirty items.
 - Intensive:** the max. temperature is changed to 60°C and the washing stage is extended to increase the effectiveness of the enzymes in the detergents. Suitable for delicate but dirty items.
 - Easy iron:** produces items which are less creased and easy to iron.
 - Water plus:** Increases the amount of water used for washing and rinses.
 - In alternative **Extra rinse:** this option adds a rinse to the selected washing programme.
 - Flexi Time:** reduces the duration of the cycle. The symbol is completely illuminated with the initial duration of the selected programme. Once the option has been selected the cycle duration can be further reduced to an intermediate setting and a minimum setting and then returned to the initial duration by repeated pressing of the Set button
 - In alternative **Rapid:** reduces the duration of the washing cycle. Suitable for small amounts of laundry with only light dirt.
 - Buzzer:** sets whether or not the buzzer will sound at the end of the cycle. The appliance comes with the buzzer function "on".
- To confirm the selected option, simply press the Confirm options button and the LED of the option remains on.
- To delete an option selection, simply return to the option with the Selection button and press the Confirm options button. To annul all the options previously selected in a single operation, simply hold down the Confirm options button for 4 seconds.
- The Buzzer option retains its "on" or "off" status for subsequent cycles. It is only automatically switched to "off" if the Night Wash programme is chosen.

4.12 TIME TO END

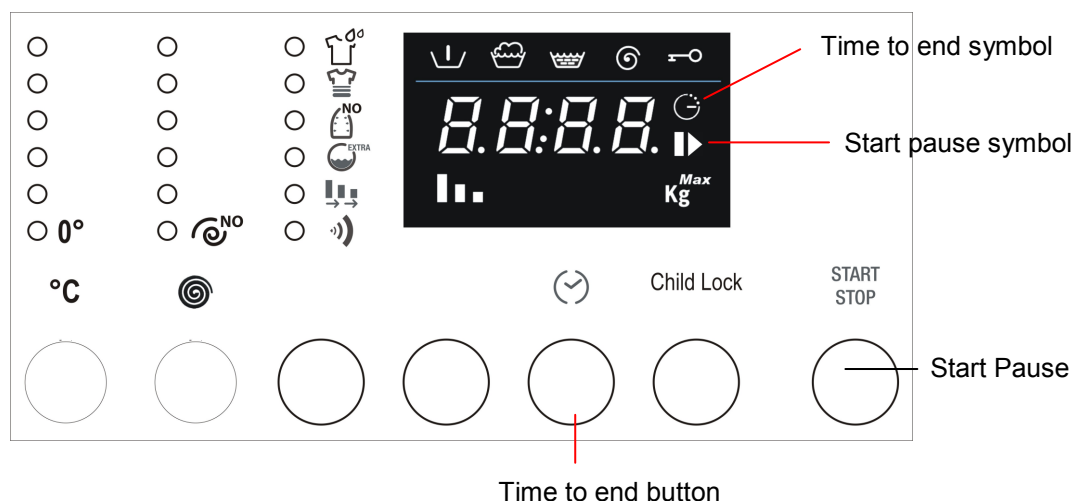

1. The Time to End can be pressed repeatedly to select the time after which the washing programme will end. The time left before the end of the cycle calculates the initial duration of the washing cycle, the settings made (temperature, spin speed and options) which may shorten or lengthen the cycle's initial duration, and the delay time the user wishes to add before the cycle starts.
2. After the Time to End function has been set, the symbol on the display remains on.
3. To annul the Delay Timer function, keep pressing the button repeatedly until the display shows 0.
4. The Start Pause symbol flashes on and off until the cycle starts. After the cycle starts, the symbol remains constantly lit.

4.13 STARTING THE WASHING PROGRAMME

1. To start the washing programme after making your personal settings, press the Start Pause button.
2. Once the cycle has started, the display shows the time remaining before the end of the cycle and the Start Pause symbol on the display is constantly on.
3. During performance of the washing programme, the symbols which identify the various phases light up:

Cycle phase symbols: Prewash, wash, rinse and final spin.

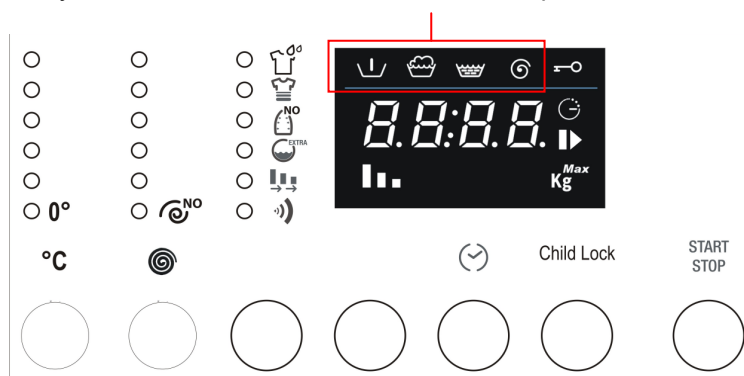

4.14 INTERRUPTING OR CHANGING THE WASHING PROGRAMME

The washing programme in progress can be interrupted at any moment:

1. Press the "Start/Pause" button for about 3 seconds: the display shows the word PAUS (for 1 second) alternating with the time remaining until the end of the cycle (for 1 second). The Start/Pause light flashes on and off.
Programmes can also be interrupted by turning the programme/temperature setting knob while the cycle is in progress.
2. To change the washing programme, simply turn the programme knob to select the new programme; there is no need to set the appliance in pause status. The new cycle will be carried out completely, beginning from the start. If the tank had already been filled with water during the previous cycle, the water intake phase will be omitted from the new programme.
3. To restart the cycle, press the Start-Pause button again.

4.15 PROGRAMME END

Washing programmes are completed automatically. The word END appears on the display and the "Time remaining" light goes out.

1. **Switch the appliance off by turning the programmes knob to OFF**
2. Unload the laundry from the drum.
3. Leave the door ajar to allow the interior of the washing machine to dry out.
4. **Turn off the water intake tap.**

If during the initial spin speed setting stage, the "no spin" mode with stop with tank full  (spin speed set as 0) was selected, at the end of the washing programme the word STOP appears on the display, alternating with ---- (spin speed of 0) and the spin light is on.

To proceed with the pump-out and spin, press the spin selection button twice. The appliance restarts the cycle with the pump-out and spin. To select the spin speed required, press the button until the chosen speed is displayed. To pump out the water from the tank without performing the spin, press the spin selection button until the display indicates speed of 0: the pump-out will be run without spin.

4.16 CHILD LOCK

1. When this function is activated, the modification of options, temperatures, spin speed and the washing/drying cycle is not possible while the cycle is in progress.

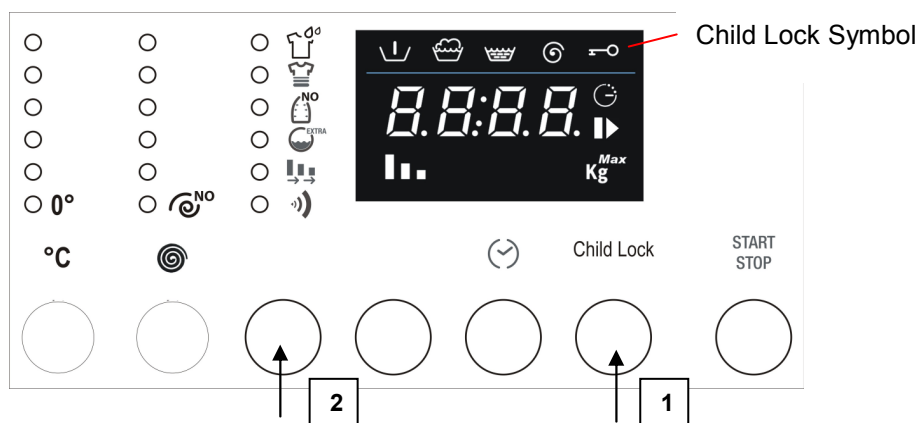

2. To activate the Child Lock Function, press the Child Lock (1) button and hold it down. Also press the Option selection (2) button within 3 seconds.
3. The Child Safety Function symbol lights up to show that the function has been activated.
4. Repeat the same procedure to deactivate the function.

4.17 OPENING THE APPLIANCE IN AN EMERGENCY

In the event of a power failure, the door is opened using the mechanical release device activated by means of the lever in the bottom of the appliance:

- Turn the knob to Off and disconnect the power supply plug from the socket.
- Drain off the water (see point 5.4)
- Pull the lever down and open the door.

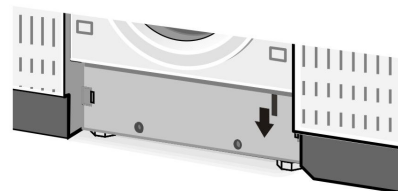

Warning, scolding hazard: before opening the door, check that the appliance does not contain boiling hot water and detergent which may pour out and cause injury when the door is opened.

Warning: do not open the door using the emergency release lever while the drum is turning.

5. CLEANING AND MAINTENANCE

Important – Before carrying out any cleaning or maintenance procedure, the plug must be disconnected from the power supply socket.

5.1 CLEANING THE OUTSIDE OF THE APPLIANCE

- Regular, thorough cleaning will keep your appliance looking good.
- Clean the exterior of the appliance with soap and water only, then dry thoroughly with a soft cloth.
- The plastic parts should just be wiped with a damp cloth.
- Do not scrape with pointed objects, or use solvents or products containing abrasive substances because they damage the surfaces.
- **For reasons of safety, never spray the washing machine with jets of water.**

5.2 CLEANING THE DRUM

- Remove any rust marks from the drum using a stainless steel cleaner, or very fine sandpaper for particularly stubborn cases.
- For descaling the washing machine use only brand-name descalers which contain an anti-corrosion agent for washing machines.
- Always follow the producer's instructions with regard to use and dosages.
- **After descaling or removing rust from the drum, carry out a few rinse cycles to remove all acid residues which might damage the appliance. Never use cleaners which contain solvents. There is the risk of the formation of vapours which might catch fire and explode.**

5.3 CLEANING THE DOOR GASKET

Check regularly that there are no paper clips, buttons, nails or pins in the folds of the door gasket.

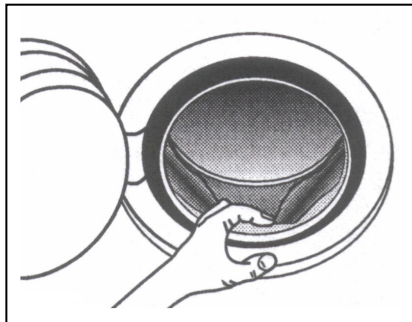

5.4 CLEANING THE DRAIN PUMP

The drain pump only needs cleaning if it has been blocked by buttons, brooches or similar objects and the water is not being pumped out.

In this case, proceed as described below.

1. Remove the mains plug to disconnect the appliance from the electricity supply.

2. Depending on the model, proceed as follows:
Built-in/totally concealed model – use a small screwdriver as a lever to remove the plugs shown here, turn the plinth downwards and access the pump.

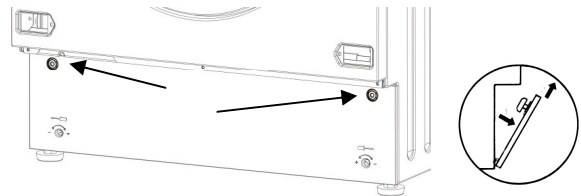

Free-Standing Model – Insert a small screwdriver through the slits in the front of the plinth, then apply upward leverage with the screwdriver to release the top of the plinth from the cabinet.

Tilt the plinth forward slightly and pull it upward to remove it completely.

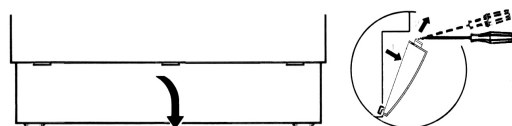

3. Extract the drain hose "A".

Warning: if the hose is hot, the water is hot or boiling hot. Place a shallow container on the floor and remove the plug "B" to drain off the water.

Depending on the amount of water in the appliance, the container may have to be emptied several times.

When no more water is coming out, close the hose again by pushing the plug "B" firmly back into place.

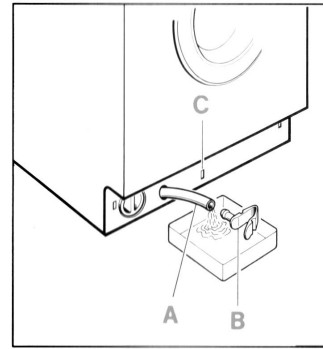

4. Unscrew the cover of the pump "D" by turning it to the left.

Clean the pump and remove any foreign bodies.

Also check the inside "E", making sure that the impeller turns freely; any foreign bodies stuck in it must be removed.

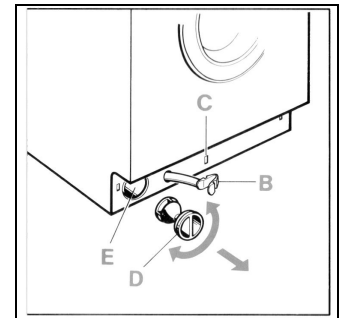

5. Screw the cover back on the pump.

Secure the drain house by snapping the plug back into place "C".

Depending on the model, replace the plinth as follows:

Built-in/completely concealed model - Fit the bottom of the plinth first. Push it towards the cabinet and put the plugs back into place.

Free-standing model - Fit the bottom of the plinth first and then push it towards the cabinet until it snaps into place.

5.5 CLEANING THE DETERGENT DRAWER

The detergent drawer should be kept clean, removing all solid deposits.

To simplify this operation, completely remove the detergent drawer (pull the drawer fully out, press in the zone marked PUSH and then remove completely).

Remove the siphon "A" and clean all parts with hot water.

Fully re-insert the siphon and remove any detergent deposits before putting the drawer back in position.

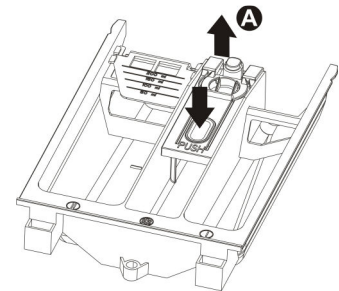

5.6 CLEANING THE WATER INTAKE FILTERS

The machine is fitted with a filter which protects the water intake valves.

The filter is in the fitting on the intake hose which is connected to the tap

The filter must be cleaned if the washing machine is not taking in water or the amount of water is insufficient.

To clean, proceed as follows:

- **Remove the mains plug to disconnect the appliance from the electricity supply.**
- Turn off the water tap.
- Unscrew the intake hose fitting from the tap.
- Unscrew the intake hose fitting from the tap.
- Clean the filter with water, with the aid of a small brush.
- When screwing the intake hose fitting back into place, check that the filter is positioned correctly.

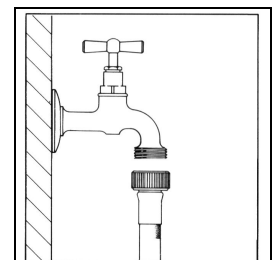

6. TROUBLESHOOTING

This produce complies with the relevant regulations governing the safety of electrical equipment. For safety reasons, any technical inspections or repairs must be performed by qualified staff, to prevent all hazards for the user.

If the appliance does not work, before calling the After-Sales Service, to avoid unnecessary expense, check yourself that the operations listed in this [troubleshooting table](#) have been carried out..

- | | |
|---|--|
| 1 Appliance does not start | Check that: <ul style="list-style-type: none"> - plug is properly connected to socket - door is securely closed - "Start/Pause" button has been pressed. |
| 2 No water filling | Check that: <ul style="list-style-type: none"> - plug is properly connected to socket - door is securely closed - water tap is turned on - water intake hose filters not fouled. - water intake hose not trapped or kinked. |
| 3 No water visible in washing drum | No malfunction.
The water level is below the level of the glass in the door because new appliances use very little water to achieve the same washing and rinsing results. |
| 4 Water not pumped out | Check that: <ul style="list-style-type: none"> - drain hose is not kinked - drain pump not fouled. |
| 5 Water not pumped out after last rinse in delicate fabrics and wool wash programmes | It is not a malfunction: pause programmed into washing programme to prevent creasing of fabrics.
To pump out water, proceed as described in "Programme End" point. |
| 6 Water takes in and pumps out water continually | Check that end of drain hose is not too low down. |
| 7 Strong vibrations during spins | Check that: <ul style="list-style-type: none"> - Appliance is properly levelled - washing machine not too close to walls or kitchen units - internal unit on flexible mounts locked in position. |
| 8 Too much foam formed in tank and flowing out of drawer | Check that: <ul style="list-style-type: none"> - detergent used is recommended for automatic washing machines and not for hand washing - quantity used is as stated in manual and no more |
| 9 Water on floor | Check that: <ul style="list-style-type: none"> - water intake hose fittings not loose - end of drain hose still correctly positioned. |
| 10 Not all fabric conditioner used or too much water left in compartment | Check that detergent drawer siphons are correctly fitted and not fouled. |

Instructions for use the LBB Washing Machine



<i>Index</i>	Pag.
1. Instructions for unpack and transport	2
2. Plinth dismount	3
3. Rubber strap dismount	4
4. Rubber strap use	5
5. Door dismount	6
6. Cleaning	7

1. Instruction for unpack and transport



NO

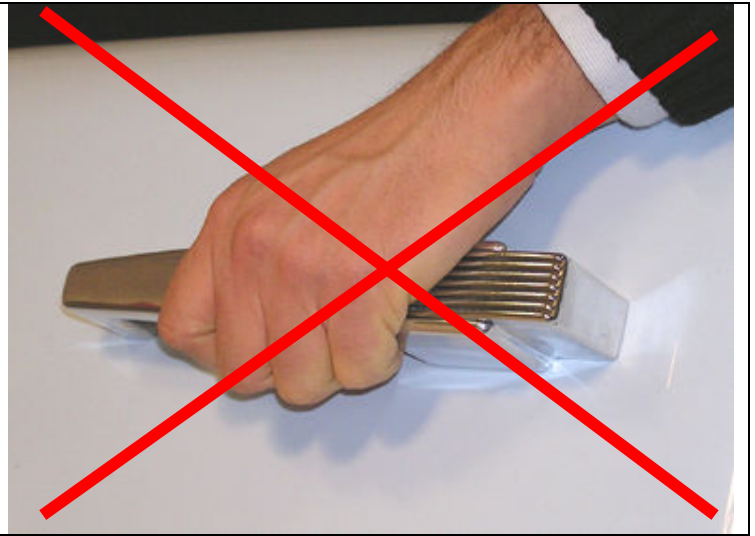

NO



NO



NO

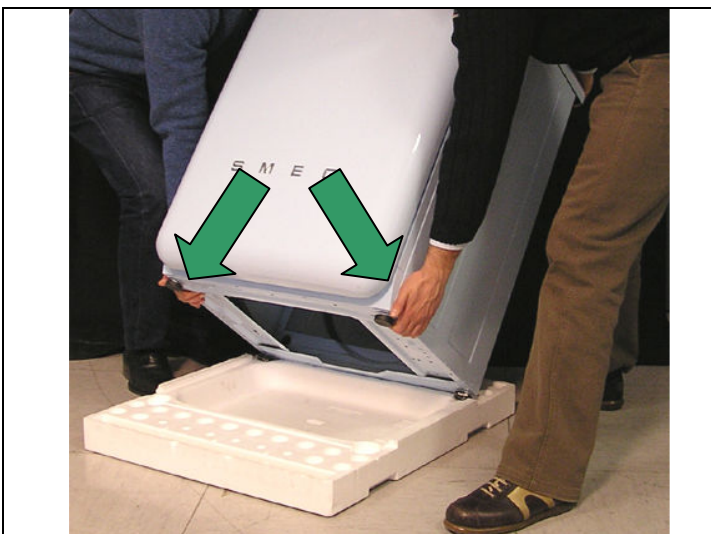

YES



YES

2. Plinth dismount

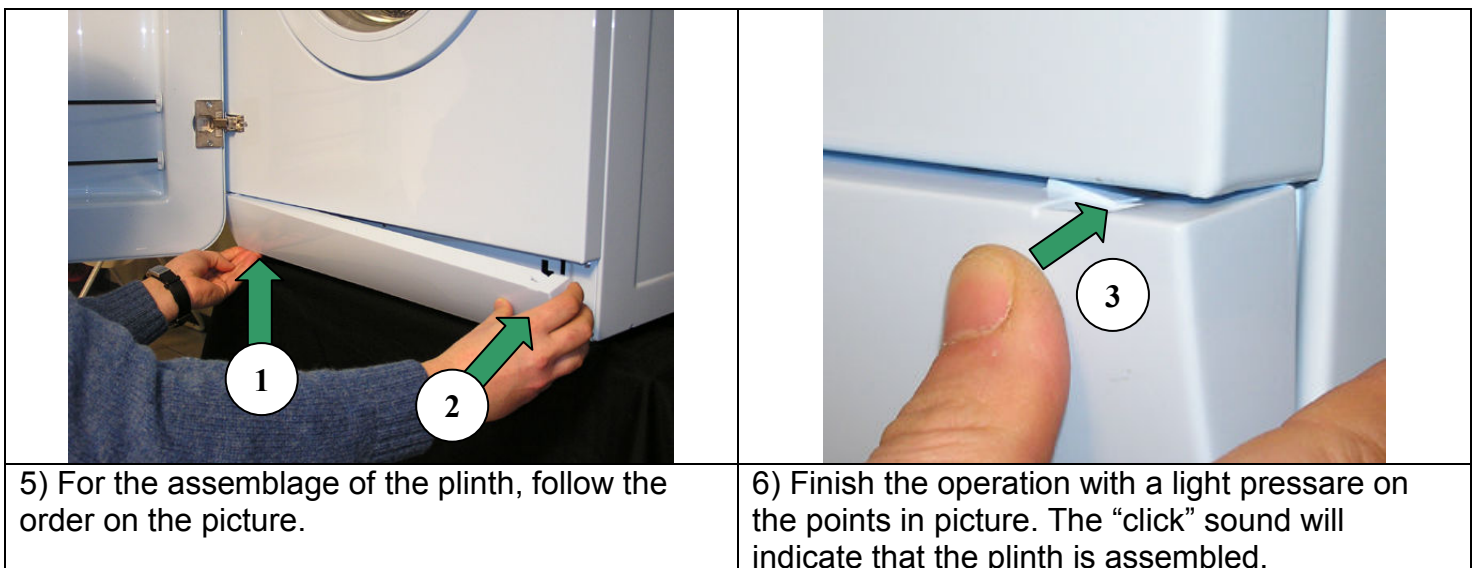
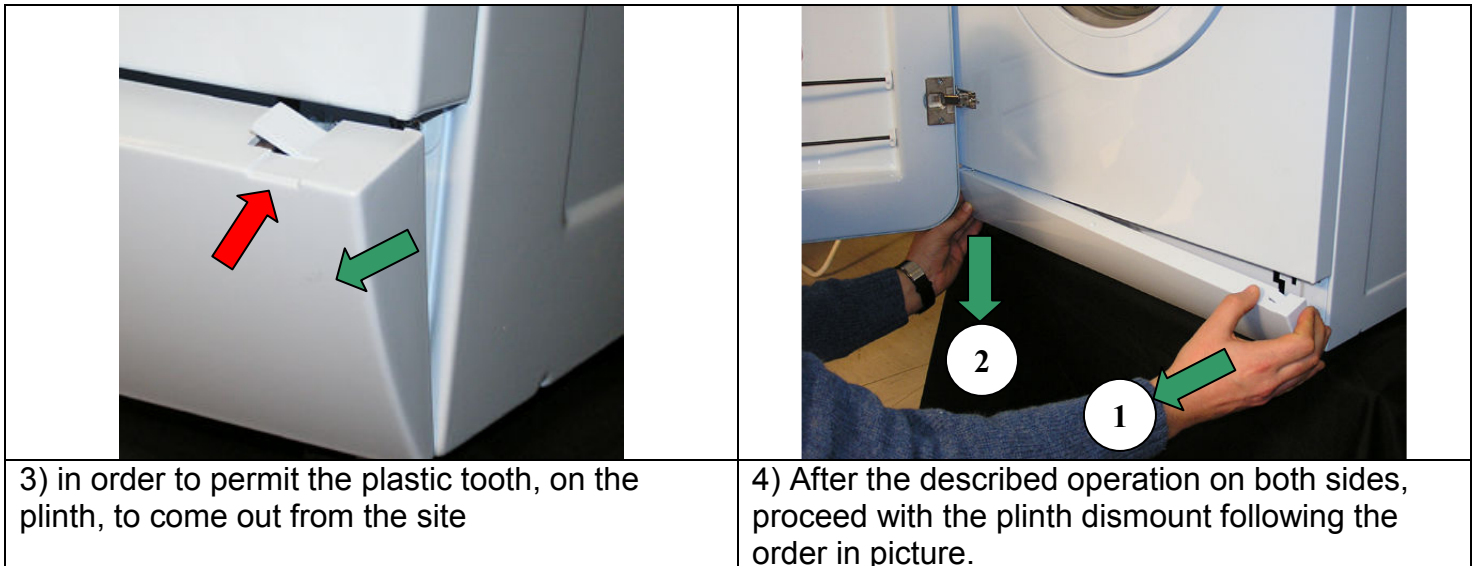
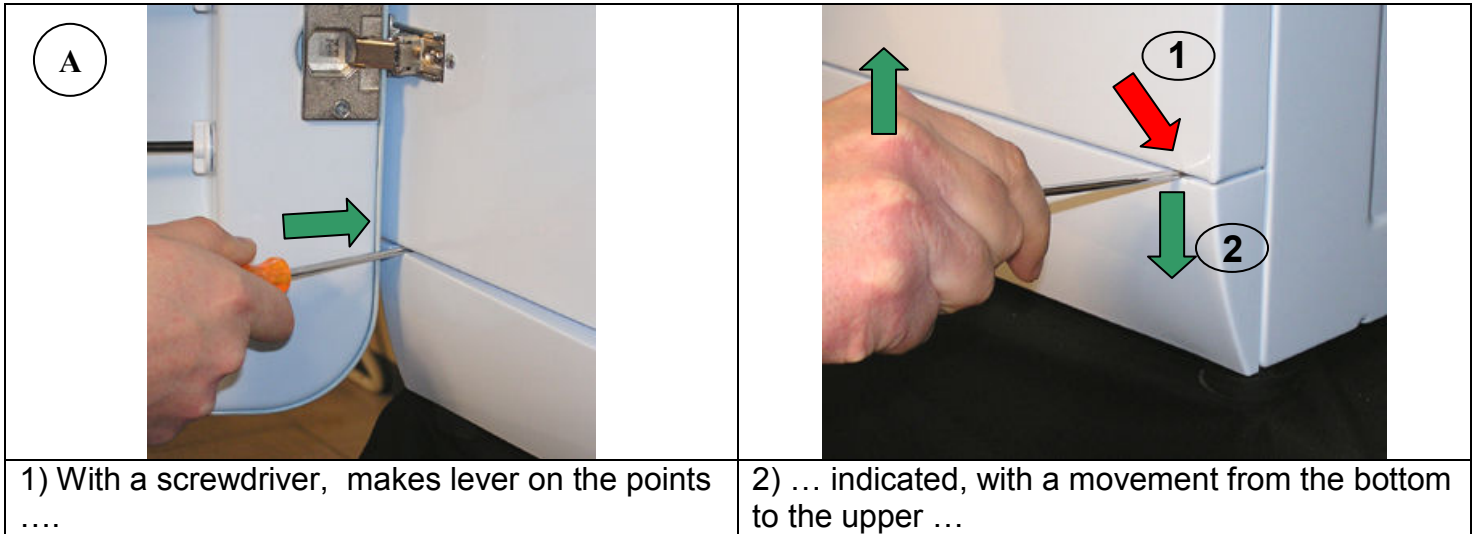

3. Rubber strap dismount

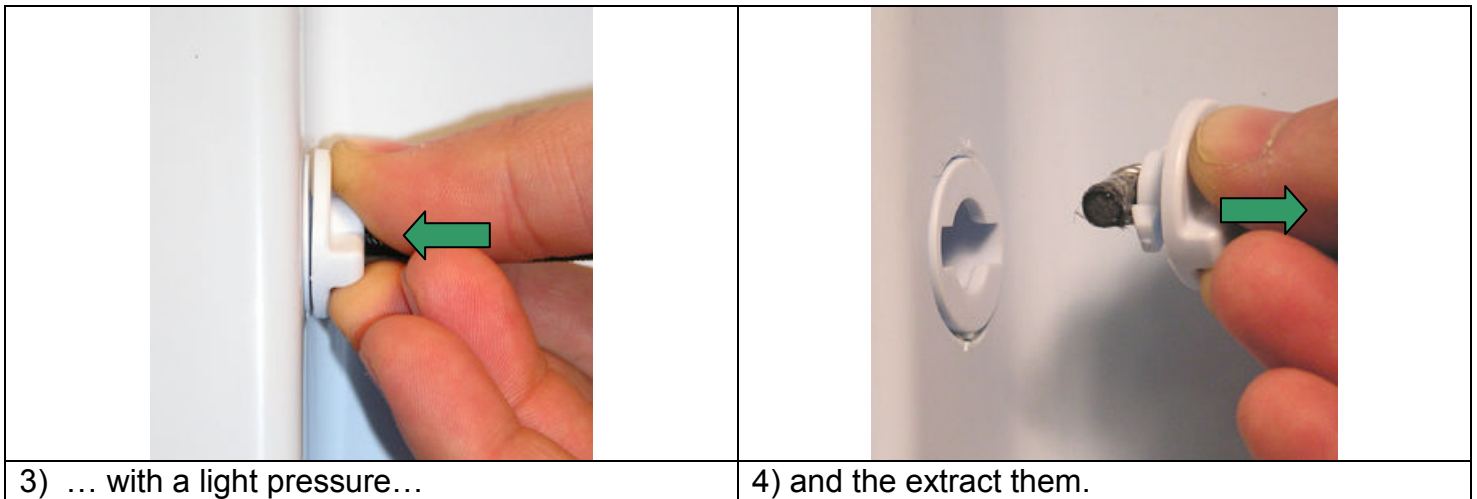
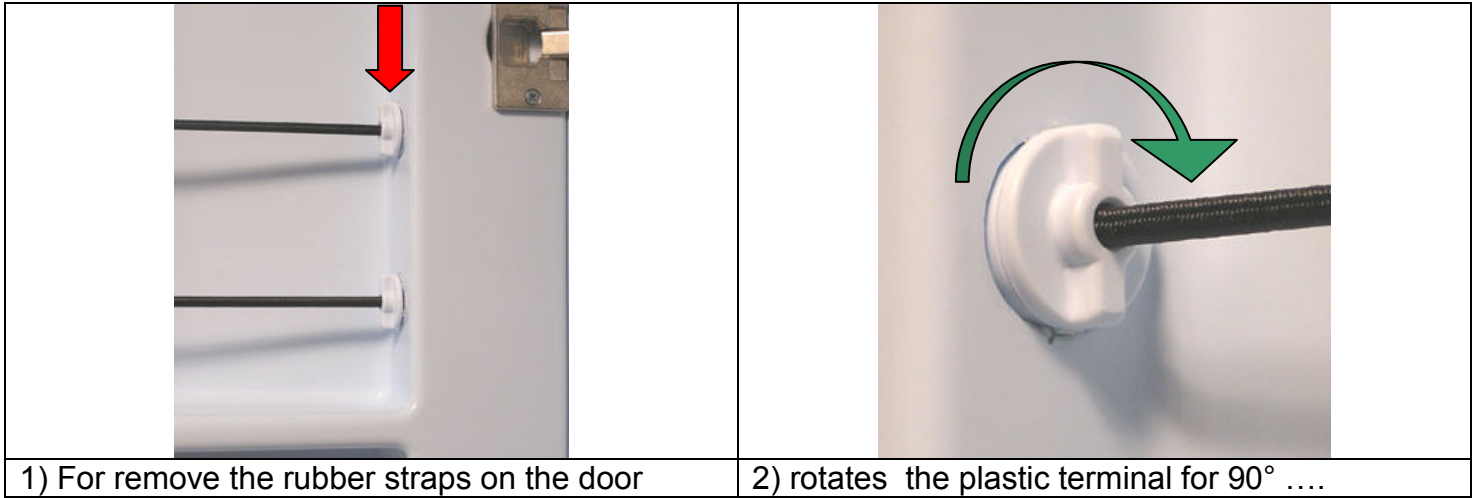

4. Rubber strap use



In picture, the possibility to insert some products in the vain can be appreciated ...

ATTENTION:
Weight Max 4,0kg



... these products are of daily use, e.g. detergents, softener etc.

ATTENTION

This appliance is intended for use by adults.

Do not allow children to tamper with the controls or play with the washing machine.

Do not allow children to approach the appliance.

Keep children away from the appliance.

5. Door dismount

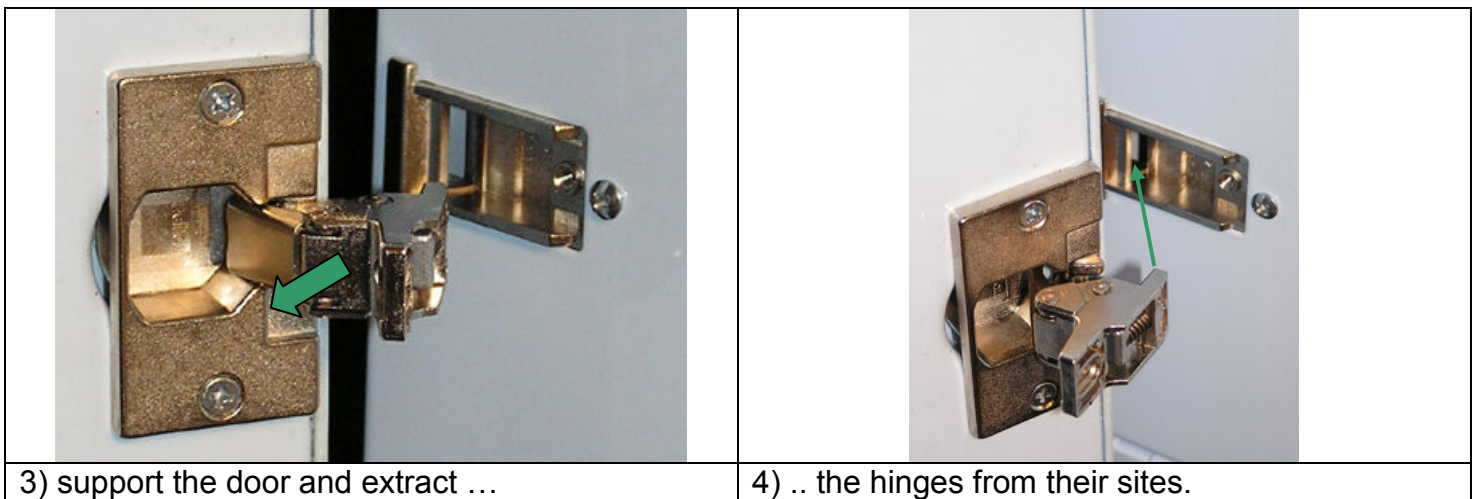
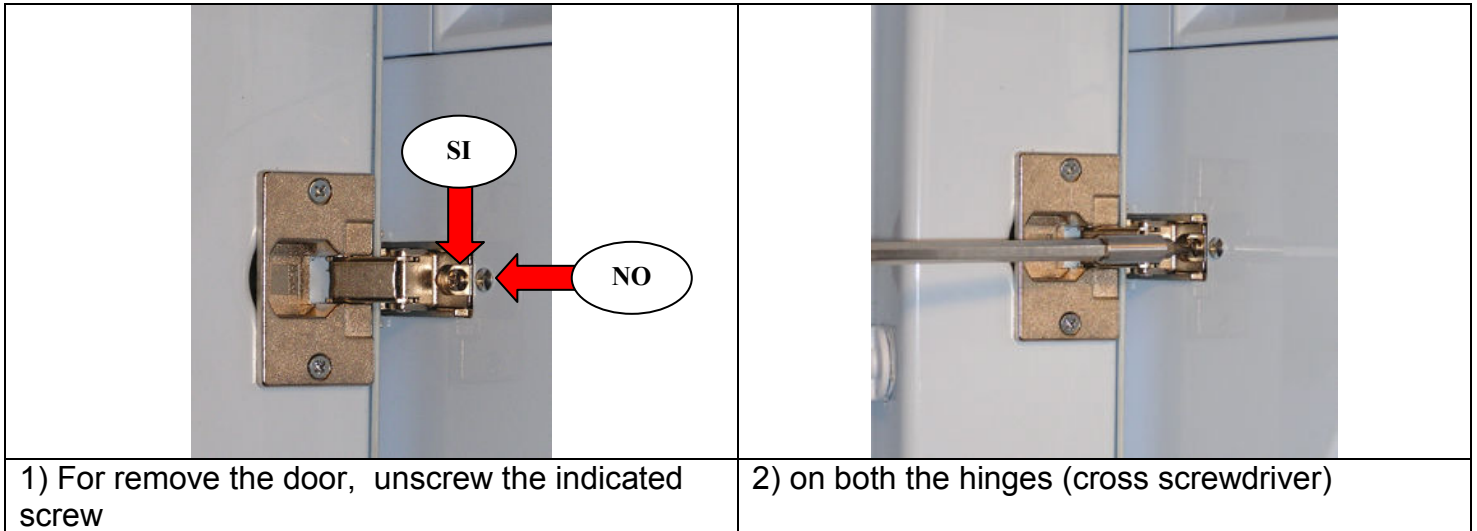

6. Instruction for cleaning

Instructions for the cleaning of the product:

The surfaces have to be cleaned with water and soft clothes (e.g. micro fiber)

Do not use never chemical products or aggressives (e.g. abrasives clothes, etc.)



YES



NO





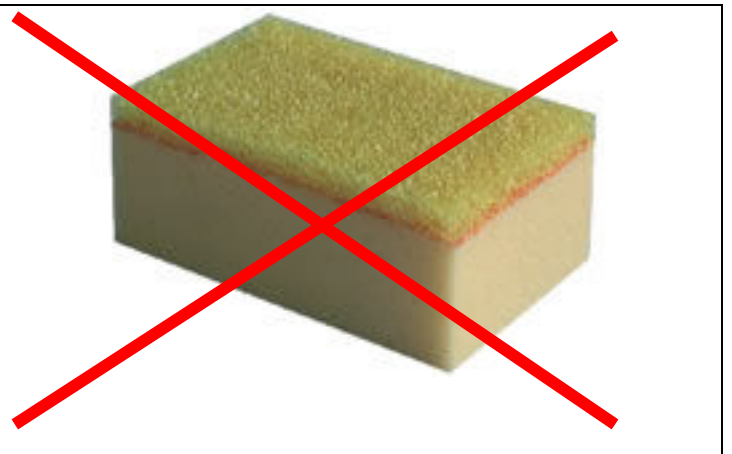































YES





NO

PROGRAM GUIDE

Programs		Temp. (°C)	Max. Spin (rpm)	Max. washing load (kg)	Detergent drawer compartments			Options					Wash program description
					Prewash	Wash	Softner	Prewash	Intensive	Easy Iron	Extra rinse	Flexi time	
													
Cotton and coloureds 	Delicate coloureds with light dirt	 → 30°	Max	7	✓	✓	✓	✓	✓	✓	✓	✓	Cold wash → 30°C, rinses and final spin at the selected speed
	Delicate coloureds with normal dirt	40°	Max	7	✓	✓	✓	✓	✓	✓	✓	✓	Wash at 40°C, rinses and final spin at the selected speed
	Tough coloureds with normal dirt	60°	Max	7	✓	✓	✓	✓	✓	✓	✓	✓	Wash at 60°C, rinses and final spin at the selected speed
	Tough coloureds with heavy dirt	90°	Max	7	✓	✓	✓	✓	✓	✓	✓	✓	Wash at 90°C, rinses and final spin at the selected speed
Cotton Eco 	Delicate coloureds with light dirt	 → 30°	Max	7	✓	✓	✓	✓	-	✓	✓	✓	Cold wash → 30°C, rinses and final spin at the selected speed
	Delicate coloureds with normal dirt	◀ 40°	Max	7	✓	✓	✓	✓	-	✓	✓	✓	Wash at 40°C, rinses and final spin at the selected speed (Standard cycle without any option selected)
	Tough coloureds with normal dirt	◀ 60°	Max	7	✓	✓	✓	✓	-	✓	✓	✓	Wash at 60°C, rinses and final spin at the selected speed (Standard cycle without any option selected)
Synthetics 	Items for refreshing	 / 20°	1000	3,5	✓	✓	✓	✓	✓	-	✓	✓	Cold wash or 20°C, rinses and final spin at the selected speed
	Items with light dirt	30° / 40°	1000	3,5	✓	✓	✓	✓	✓	-	✓	✓	Wash at 30° or 40 °C, rinses and final spin at the selected speed
	Items with normal dirt	60°	1000	3,5	✓	✓	✓	✓	✓	-	✓	✓	Wash at 60°C, rinses and final spin at the selected speed
Delicate/Silk 	Items for refreshing	 / 20°	600	2	-	✓	✓	-	✓	-	✓	-	Cold wash or 20°C, rinses and final spin at the selected speed
	Items with light dirt	30° / 40°	600	2	-	✓	✓	-	✓	-	✓	-	Wash at 30° or 40 °C, rinses and final spin at the selected speed
Wool 	Items for refreshing	 / 20°	800	2	-	✓	✓	-	-	-	-	-	Cold wash or 20°C, rinses and final spin at the selected speed
	Items with light dirt	30° / 40°	800	2	-	✓	✓	-	-	-	-	-	Wash at 30° or 40 °C, rinses and final spin at the selected speed
Rinse and spin 		-	Max	7	-	-	✓	-	-	✓	-	-	Rinse and pump-out only, or pump-out and final spin at the selected speed
Pump-out and spin 		-	Max	7	-	-	-	-	-	✓	-	-	Pump-out only, or pump-out and final spin at the selected speed
Rapid 	Light cotton or delicate fabrics for refreshing	 → 30°	800	2	-	✓	✓	-	-	-	-	-	Cold wash → 30°C, rinses and final spin at the selected speed
Night Wash 	Very delicate items with light dirt	 → 30°	1000	3	✓	✓	✓	✓	✓	✓	-	-	Silent cold wash → 30°C (buzzer off), rinses and final spin at the selected speed
	Items with light dirt	40°	1000	3	✓	✓	✓	✓	✓	✓	-	-	Silent wash at 40°C (buzzer off), rinses and final spin at the selected speed
	Items with normal dirt	60°	1000	3	✓	✓	✓	✓	✓	✓	-	-	Silent wash at 60°C (buzzer off), rinses and final spin at the selected speed
Softner 		-	800	3,5	-	-	✓	-	-	✓	-	-	Rinse and pump-out only, or pump-out and final spin at the selected speed
Hand wash 	Items for refreshing		800	2	-	✓	✓	-	-	-	-	-	Cold wash, rinses and final spin at the selected speed
Shirt/Work 	Items for refreshing	 / 20°	800	2	-	✓	✓	-	✓	-	✓	✓	Cold wash or 20°C, rinses and final spin at the selected speed
	Items with light dirt	30° / 40°	800	2	-	✓	✓	-	✓	-	✓	✓	Wash at 30° or 40 °C, rinses and final spin at the selected speed
Jeans 	Items for refreshing	 / 20°	800	2	-	✓	✓	-	✓	-	✓	✓	Cold wash or 20°C, rinses and final spin at the selected speed
	Items with light dirt	30° / 40°	800	2	-	✓	✓	-	✓	-	✓	✓	Wash at 30° or 40 °C, rinses and final spin at the selected speed
Sport 	Items for refreshing	 / 20°	800	2	-	✓	✓	-	✓	-	✓	✓	Cold wash or 20°C, rinses and final spin at the selected speed
	Items with light dirt	30° / 40°	800	2	-	✓	✓	-	✓	-	✓	✓	Wash at 30° or 40 °C, rinses and final spin at the selected speed
Mixed	Cotton and synthetics for refreshing	 / 20°	1200	3	✓	✓	✓	✓	✓	✓	✓	✓	Cold wash or 20°C, rinses and final spin at the selected speed
Mix	Cotton and synthetics with light dirt	30° / 40°	1200	3	✓	✓	✓	✓	✓	✓	✓	✓	Wash at 30° or 40 °C, rinses and final spin at the selected speed

✓ Option available

  : Options which cannot be selected simultaneously