



**FROST FREE REFRIGERATOR**

**Freezer - Fridge**

Instruction booklet

**ELETTRONICO FROST FREE**

**Congelatore – Frigo**

Istruzioni per l'uso

**FROST FREE REFRIGERATOR**

**Freezer - Fridge**

Instruction booklet

**RÉFRIGÉRATEUR A FROID VENTILE**

**Congélateur - Réfrigérateur**

Guide d'utilisation

**FROST FREE REFRIGERATOR**

**Freezer - Fridge**

Instruction booklet

**FRIGORIFICO NO FROST**

**Congelador - Frigorífico**

Manual de Instrucciones

**FD43PSNF4  
FD43PMNF4  
FD43PXNF4**



# Index

<b>BEFORE USING THE APPLIANCE .....</b>	<b>2</b>
General warnings .....	2
Old and out-of-order fridges .....	4
Safety warnings .....	4
Installing and operating your fridge .....	5
Before Using your Fridge.....	6
<b>THE VARIOUS FUNCTION AND POSSIBILITIES .....</b>	<b>7</b>
Information about New Generation Cooling Technology .....	7
Thermostat Setting .....	8
Warnings about Temperature Adjustments.....	8
Accessories .....	9
Icematic.....	9
Chiller Shelf.....	10
Fresh dial .....	10
Adjustable door shelf .....	10
<b>ARRANGING FOOD IN THE APPLIANCE .....</b>	<b>11</b>
Refrigerator Compartment.....	11
Freezer Compartment .....	12
<b>CLEANING AND MAINTENANCE .....</b>	<b>13</b>
<b>TRANSPORTATION AND CHANGING OF INSTALLATION POSITION .....</b>	<b>15</b>
Repositioning the Door .....	15
<b>BEFORE CALLING YOUR AFTER SALES SERVICE.....</b>	<b>15</b>
Tips for saving energy .....	17
<b>THE PARTS OF THE APPLIANCE AND THE COMPARTMENTS .....</b>	<b>18</b>

## **PART - 1. BEFORE USING THE APPLIANCE**

### **General warnings**

**WARNING:** Keep ventilation openings, in the appliance enclosure or in the built-in structure, clear of obstruction.

**WARNING:** Do not use mechanical devices or other means to accelerate the defrosting process, other than those recommended by the manufacturer.

**WARNING:** Do not use electrical appliances inside the food storage compartments of the appliance, unless they are of the type recommended by the manufacturer.

**WARNING:** Do not damage the refrigerant circuit.

**WARNING:** To avoid a hazard due to the instability of the appliance, it must be fixed in accordance with the instructions.

- If your appliance uses R600a as a refrigerant – you can learn this information from the label on the cooler- you should be careful during shipment and installation to prevent your appliance's cooler elements from being damaged. Although R600a is an environmentally friendly and natural gas. As it is explosive, in the event of a leak due to damage to the cooler elements, move your fridge from open flame or heat sources and ventilate the room where the appliance is located for a few minutes.
- While carrying and positioning the fridge, do not damage the cooler gas circuit.
- Do not store explosive substances such as aerosol cans with a flammable propellant in this appliance.
- This appliance is intended to be used in household and similar applications such as;
  - staff kitchen areas in shops, offices and other working environments

- farm houses and by clients in hotels, motels and other residential type environments
- bed and breakfast type environments;
- catering and similar non-retail applications
- If the socket does not match the refrigerator plug, it must be replaced by the manufacturer, its service agent or similarly qualified persons in order to avoid a hazard.
- A specially grounded plug has been connected to the power cable of your refrigerator. This plug should be used with a specially grounded socket of 16 amperes. If there is no such socket in your house, please have it installed by an authorized electrician.
- This appliance can be used by children aged from 8 years and above and persons with reduced physical, sensory or mental capabilities or lack of experience and knowledge if they have been given supervision or instruction concerning use of the appliance in a safe way and understand the hazard involved. Children shall not play with the appliance. Cleaning and user maintenance, shall not be made by children without supervision.
- If the supply cord is damaged, it must be replaced by the manufacturer, its service agent or similar qualified persons in order to avoid a hazard.

## Old and out-of-order fridges

- If your old fridge has a lock, break or remove the lock before discarding it, because children may get trapped inside it and may cause an accident.
- Old fridges and freezers contain isolation material and refrigerant with CFC. Therefore, take care not to harm environment when you are discarding your old fridges.

## Disposal of your old appliance

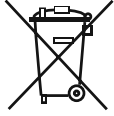

This symbol on the product or package implies that the product should not be treated as domestic waste. Instead, it should be delivered to applicable waste collection places recycling electrical and electronic equipment. You will contribute to avoid potential negative results regarding environment and human health, which will arise due to wrong waste procedure for the product by ensuring that this product is annihilated properly. Recycling materials will help natural resources be preserved. For more detailed information regarding recycling of this product, please contact local municipality, domestic waste annihilation service or the shop you have purchased the product. Please ask your municipal authority about the disposal of the WEEE for the reuse, recycle and recovery purposes.

### Notes:

- Please read the instruction manual carefully before installing and using your appliance. **We are not responsible for the damage occurred due to misuse.**
- Follow all instructions on your appliance and instruction manual, and keep this manual in a safe place to resolve the problems that may occur in the future.
- This appliance is produced to be used in homes and it can only be used in domestic environments and for the specified purposes. It is not suitable for commercial or common use. Such use will cause the guarantee of the appliance to be cancelled and our company will not be responsible for the losses to be occurred.
- This appliance is produced to be used in houses and it is only suitable for cooling / storing foods. It is not suitable for commercial or common use and/or for storing substances except for food. Our company is not responsible for the losses to be occurred in the contrary case.

## Safety warnings

- Do not use multiple receptacles or extension cord.
- Do not plug in damaged, torn or old plugs.
- Do not pull, bend or damage the cord.

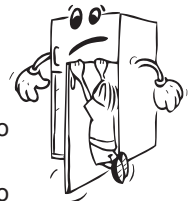

- This appliance is designed for use by adults, do not allow children to play with the appliance or let them hang off the door.
- Do not plug-in or out the plug from the receptacle with wet hands to prevent electrocution!



- Do not place glass bottles or beverage cans in the freezer department. Bottles or cans may explode.
- Do not place explosive or flammable material in your fridge for your safety. Place drinks with higher alcohol amount vertically and by closing their necks tightly in the fridge department.
- When taking ice made in the freezer department, do not touch it, ice may cause ice burns and/or cuts.
- Do not touch frozen goods with wet hands! Do not eat ice-cream and ice cubes immediately after you have taken them out of the freezer department!
- Do not re-freeze frozen goods after they have melted. This may cause health issues like food poisoning.
- Do not cover the body or top of fridge with lace. This affects the performance of your fridge.
- Fix the accessories in the fridge during transportation to prevent damage to accessories.



## Installing and operating your fridge

Before starting to use your fridge, you should pay attention to the following points:

- Operating voltage for your fridge is 220-240 V at 50Hz.
- We do not take the responsibility of the damages that occur due to ungrounded usage.
- Place your fridge in a place that it would not be exposed to direct sunlight.
- Your appliance should be at least 50 cm away from stoves, Gas ovens and heater cores, and should be at least 5 cm away from electrical ovens.
- Your fridge should never be used outdoors or left under the rain.
- When your fridge is placed next to a deep freezer, there should be at least 2 cm between them to prevent humidity on the outer surface.
- Do not place anything on your fridge, and install your fridge in a suitable place so that at least 15 cm is available on the upper side.
- The adjustable front legs should be adjusted to make sure your appliance is level and stable. You can adjust the legs by turning them clockwise (or in the opposite direction). This should be done before placing food in the fridge.
- Before using your fridge, wipe all parts back with warm water added with a tea spoonful of sodium bicarbonate, and then rinse with clean water and dry. Place all parts after cleaning.



### If your refrigerator has a fan condenser:

The condenser of your fridge is placed at the bottom of cabinet. As a result of that, details that arranges the distance between the refrigerator and the back wall at where you place the fridge, exist at the cover of the bottom of cabinet. You can move the fridge towards the back wall until that point.

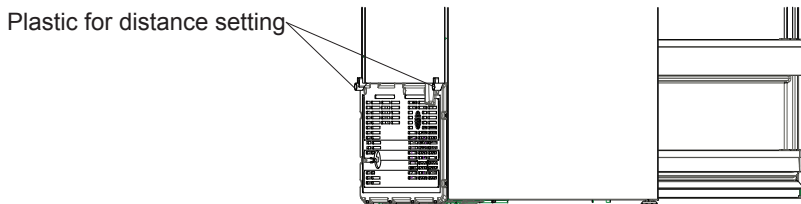

**If your fridge doesn't have a fan condenser, in other words, back side of your fridge is like below:**

- Install the plastic distance guide (the part with black vanes at the rear) by turning it 90° as shown in the figure to prevent the condenser from touching the wall.
- Refrigerator should be placed against a wall with a free distance not exceeding 75 mm.

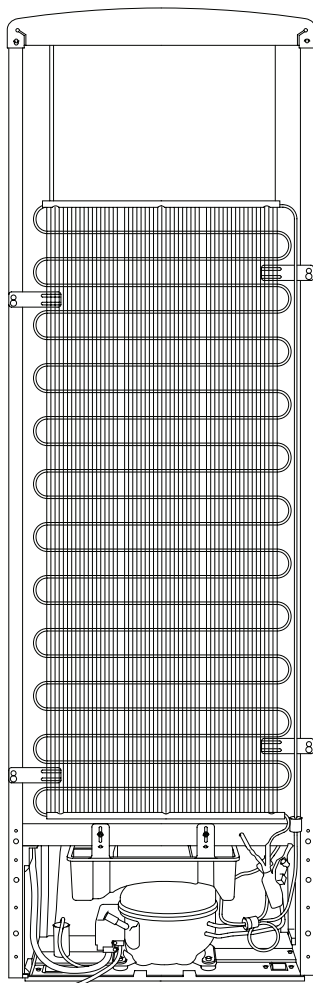
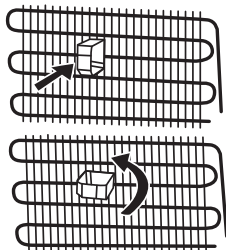

## **Before Using your Fridge**

- When it is operated for the first time or after transportation, keep your fridge in the upright position for 3 hours and plug it on to allow efficient operation. Otherwise, you may damage the compressor.
- Your fridge may have a smell when it is operated for the first time; the smell will fade away when your fridge starts to cool.

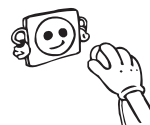



## PART - 2. THE VARIOUS FUNCTION AND POSSIBILITIES

### Information about New Generation Cooling Technology

Fridges with new generation cooling technology have a different working system than static fridges. In normal fridges, humid air that enters into fridge and the water vapor that comes out from the foods, accumulates frost formation in freezer compartment. In order to melt this frost, in other words defrost, the fridge has to be stopped. During the stopping period, to keep the foods cold, user has to extract the food to outside of fridge and user has to clear the ice during this period.

In the fridges with new generation cooling technology, situation in the freezer compartment is completely different. With the aid of fan, cold and dry air is blown out through many points into the freezer compartment. As a result of the homogeneously blown cold air, even in the spaces between shelves, foods are frozen equally and correctly. On the other hand there will be no frost formation.

In the refrigerator compartment, there will be nearly same configuration with freezer compartment. Air, that is emitted with the fan, located at the top of refrigerator compartment, is cooled while passing through the gap behind the air duct. At the same time, air is blown out through the holes on the air duct so that cooling process is successfully completed in the refrigerator compartment. Holes on the air duct are designed such that the air distribution becomes homogenous in this compartment.

As there is no air passage between freezer and refrigerator compartment, there will be no odor mixing.

As a result of these, your fridge with new generation cooling technology, gives you, ease of use beside the huge volume and esthetic appearance.

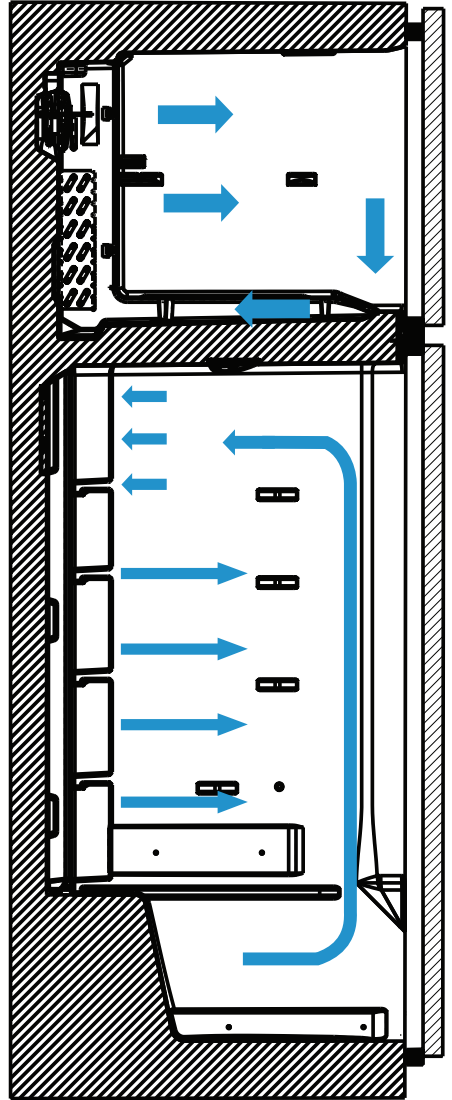

## Thermostat Setting

Freezer and refrigerator thermostat automatically regulates the inside temperature of the compartments. By rotating the knob from position 1 to 5, colder temperatures can be obtained. In cold seasons, you can set lower positions in order to decrease the energy consumption.

### Thermostat level;

- 1 – 2 : For short-term storage of food in the freezer compartment, you can set the knob between minimum and medium position.
- 3 – 4 : For long-term storage of food in the freezer compartment, you can set knob medium position.
- 5 – MAX : For freezing the fresh food. Th appliance will work longer. After you get the cold condition you must position to its original position.

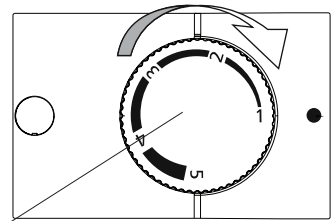
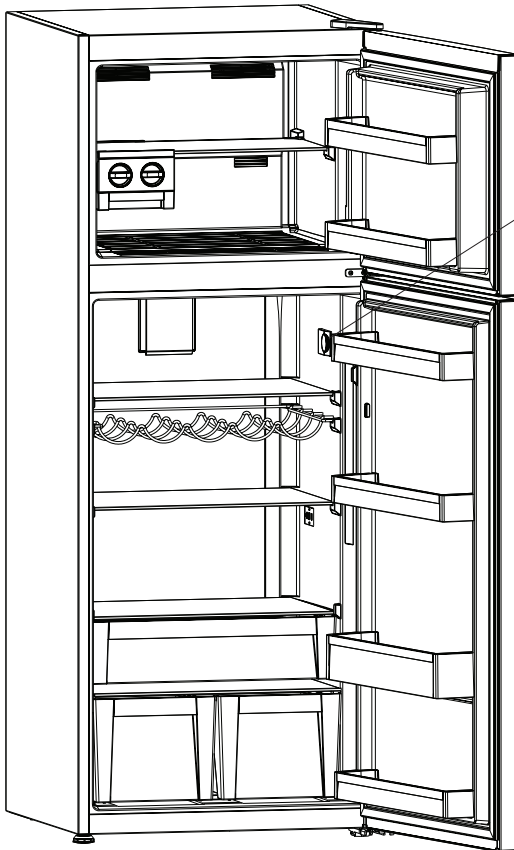

### Warnings about Temperature Adjustments

- Temperature adjustments should be made according to the frequency of door openings and the quantity of food kept inside the fridge.
- This fridge is designed to work in all ambient temperature. In the ambient temperatures colder than  $-5\text{ }^{\circ}\text{C}$ , preserving food in the refrigerator compartment isn't suggested because the foods that you put into refrigerator compartment, will have a temperature close to ambient temperature. Consequently, they will freeze. You can keep your foods until  $-5\text{ }^{\circ}\text{C}$  in refrigerator compartments. With the aid of special algorithm that is designed by engineers, foods can be preserved in the freezer compartment, colder than  $-5\text{ }^{\circ}\text{C}$  ambient temperature.

- Do not pass to another adjustment before completing an adjustment.
- Your fridge should be operated up to 24 hours according to the ambient temperature without interruption after being plugged in to be completely cooled. Do not open doors of your fridge frequently and do not place much food inside it in this period.
- If the unit is switched off or unplugged, you must allow at least 5 minutes before restarting or re-plugged the unit in order not to damage the compressor.
- Your fridge is designed to operate in the ambient temperature intervals stated in the standards, according to the climate class stated in the information label. We do not recommend operating your fridge out of stated temperatures value limits in terms of cooling effectiveness.

Climate class	Ambient (°C)
T	16 to 43 (°C)
ST	16 to 32 (°C)
N	16 to 32 (°C)
SN	10 to 32 (°C)

**Note:**

This appliance is designed to work at 43 °C ambient temperature with no problem. Below -5 °C ambient temperature, do not use refrigerator compartment as the foods that you put into there will freeze. You can continue using freezer compartment.

## Accessories

### Icematic (Making ice cubes)

- Take out the ice making tray
- Fill the water in level of line.
- Place the ice making tray in its original position
- When ice cubes are formed, twist the lever to drop off ice cubes into the icebox.

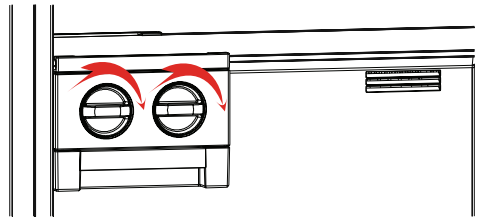

**Note:**

- Do not fill the icebox with water in order to make ice. It can be broken.
- The movement of the ice maker may be difficult while the refrigerator is running. In such a case should be cleaned by removing the glass shelves.

### Removing the Ice maker

- Take out of the freezer glass shelves
- Remove the icemaker by dragging left or right on the shelf.

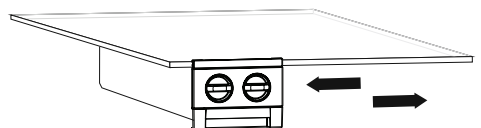

You can remove the icemaker to use a larger volume of the freezer compartment.

## Chiller Shelf

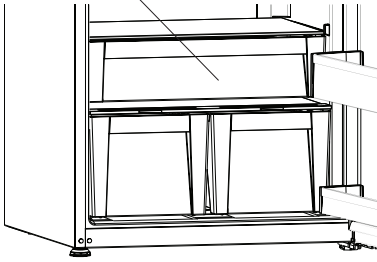

Keeping food in the Chiller compartment instead of the freezer or refrigerator compartment allows food retain freshness and flavour longer, while preserving its fresh appearance. When chiller tray becomes dirty, remove it and wash it with water.

(Water freezes at 0°C, but foods containing salt or sugar freeze at temperature lower than that)

Normally people use the chiller compartment for raw fish, lightly pickled, rice, etc...

**Do not put foods you want to freeze or ice trays in order to make ice.**

## Removing the Chiller shelf

- Pull the chiller shelf out toward you by sliding on rails.
- Pull the chiller shelf up from rail to remove.

After the chiller shelf was removed, Max. 20 kg load can be placed.

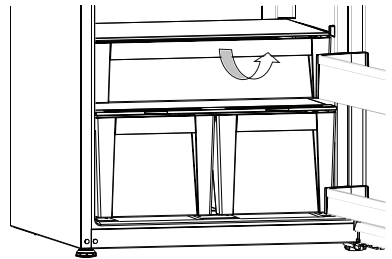

## Fresh dial

When the humidity controller in the closed position, it allows fresh fruit and vegetables to be stored longer.

In case of the crisper is totally full, the fresh dial is located in front of crisper, should be opened. By means of this the air in the crisper and humidity rate will be controlled and endurance life will be increased.

If you see any condensation on glass shelf, humidity control should be taken into the open positions.

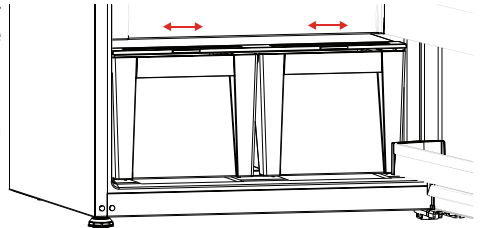

## Adjustable door shelf (In some models)

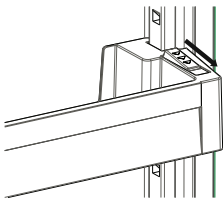

Fig.1

Six different height adjustments can be made to provide storage areas that you need by adjustable door shelf .

### To change the position of adjustable door shelf;

Hold the bottom of the shelf and pull the buttons on the side of the door shelf direction of arrow (Fig.1).

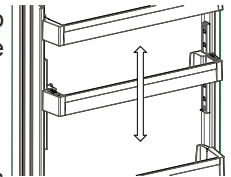

Fig.2

Position door shelf the height you need by moving up and down. After you get the position that you want the door shelf, release the buttons on the side of the door shelf (Fig.2) Before releasing the door shelf, move up down and make sure the door shelf is fixed.

**Note:** Before moving door shelf is loaded, you must hold the shelf by supporting the bottom. Otherwise, door shelf could fall off the rails due to the weight. So damage may occur on the door shelf or rails.

Visual and text descriptions on the accessories section may vary according to the model of your appliance.

## **PART - 3. ARRANGING FOOD IN THE APPLIANCE**

It will be enough to set the thermostat to “2 or 3”, for fridge to work in normal working conditions.

### **Refrigerator Compartment**

- To reduce humidity and consequent increase of frost never place liquids in unsealed containers in the refrigerator.
- Never place warm food in the refrigerator. Warm food should be allowed to cool at room temperature and should be arranged to ensure adequate air circulation in the refrigerator compartment.
- Arrange the meat and cleaned fish (wrapped in packages or sheets of plastic) which you will use in 1-2 days.
- You can put the fruits and vegetables into crisper without packing.

### **Important Note:**

- Cover any finished dishes when you put them in the fridge. Place them in the fridge when they are cool, otherwise temperature/humidity inside the fridge increases and this causes the fridge to operate more. Covering food and beverages also preserves their flavour and aroma.
- Potatoes, onion and garlic shouldn't be kept in the fridge.
- Please avoid the foods from touching to temperature sensor which is located at refrigerator compartment. In order to keep optimum preservation temperature in refrigerator compartment, foods mustn't contact with the sensor.

Temperature sensor area

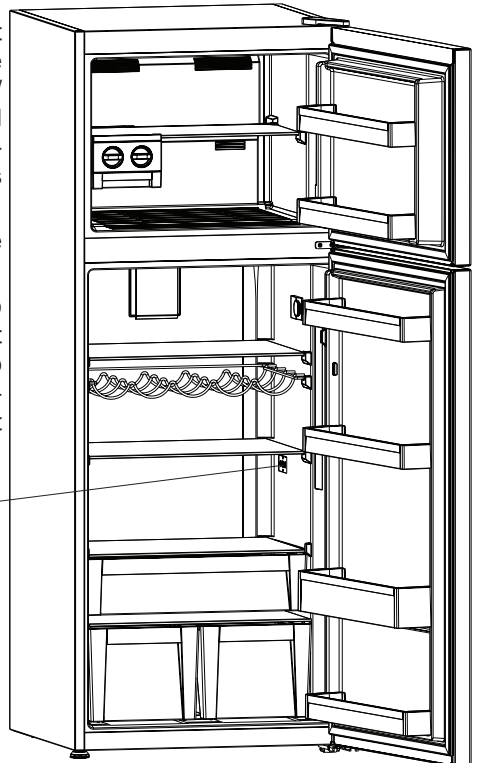

## Freezer Compartment

- The use of freezer is, storing of deep-frozen or frozen foods for long periods of time and making ice cubes.
- Do not put fresh and warm foods to the freezer door shelves to be frozen. Only use for storage of frozen foods.
- Do not put fresh and warm food with frozen food side by side as it can thaw the frozen food.
- Use the fast freezing shelf to freeze home cooking (and the foods which is wanted to freeze) more quickly because of the freezing room's greater freezing power.
- While freezing fresh foods (i.e. meat, fish and mincemeat) divide them in parts you will use in one time.
- While freezing fresh foods; Maximum amount of fresh food (in kg) that can be frozen in 24 hours is indicated on the appliance label.
- For optimum appliance performance to reach maximum freezing capacity, turn the thermostat knob to position max 24 hours before placing fresh food in the freezer.
- After placing fresh food in the freezer, 24 hours on max position is generally sufficient, After 24 hours, don not need to set the thermostat knob to position max.
- Attention; In order to save energy, When freezing small amounts of food, don not need to set the thermostat knob to position max.
- For storing the frozen foods; the instructions shown on frozen food packages should always be followed carefully and if no information is provided food should not be stored for more than 3 months from the purchased date.
- When buying frozen foods ensure that these have been frozen at suitable temperatures and that the packing is intact.
- Frozen foods should be transported in appropriate containers to maintain the quality of the food and should be returned to the freezing surfaces of the unit in the shortest possible time.
- If a package of frozen food shows the sign of humidity and abnormal swelling it is probable that it has been previously stored at an unsuitable temperature and that the contents have deteriorated.
- The storage life of frozen foods depends on the room temperature, thermostat setting, how often the door is opened, the type of food and the length of time required to transport the product from the shop to your home. Always follow the instructions printed on the package and never exceed the maximum storage life indicated.



***In some models;*** while loading the freezing compartment, the loading lines should not be passed. Otherwise, the door might remain open. In case that the freezing compartment door is left open, snow formation might occur in the freezing compartment. The problem shall not repeat itself after the snowed part is cleaned and it is made certain that its door is fully closed. Also, not closing the freezing and/or cooling compartment door would increase your energy consumption.

With putting the foods onto the air suction hole by extracting the the lower shelf located at freezer door, will affect the performance of the fridge, negatively. Therefore, please be careful while loading the freezer compartment in order not to close down the air suction hole.

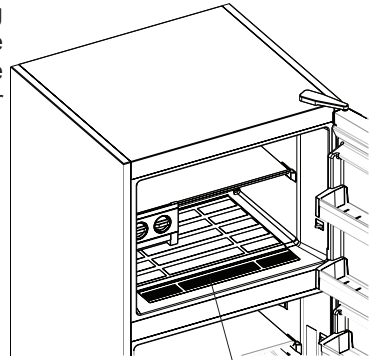

Air suction hole

## **PART - 4. CLEANING AND MAINTENANCE**

- Make sure to unplug the fridge before starting to clean it.

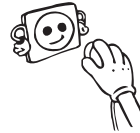

- Do not wash your fridge by pouring water.



- You can wipe the inner and outer sides with a soft cloth or a sponge using warm and soapy water.

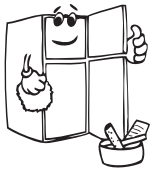
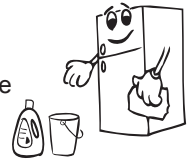

- Remove the parts individually and clean with soapy water. Do not wash in washing machine.



- Never use flammable, explosive or corrosive material like thinner, gas, acid for cleaning.

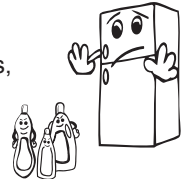

- You should clean the condenser with broom at least once a year in order to provide energy saving and increase the productivity.

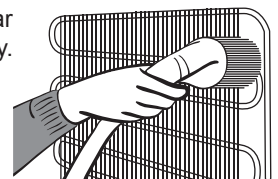

***Make sure that your fridge is unplugged while cleaning.***

## Replacing The Light Led (If the illumination is occurred via LED strip)

1 led strip in freezer compartment and 2 led strips in cooler compartment are used to illuminate your appliance.

Please call the service man.

**Note:** Numbers and location of led strips may be changed according to the model.

**!!! Some versions may be without freezer illumination.**

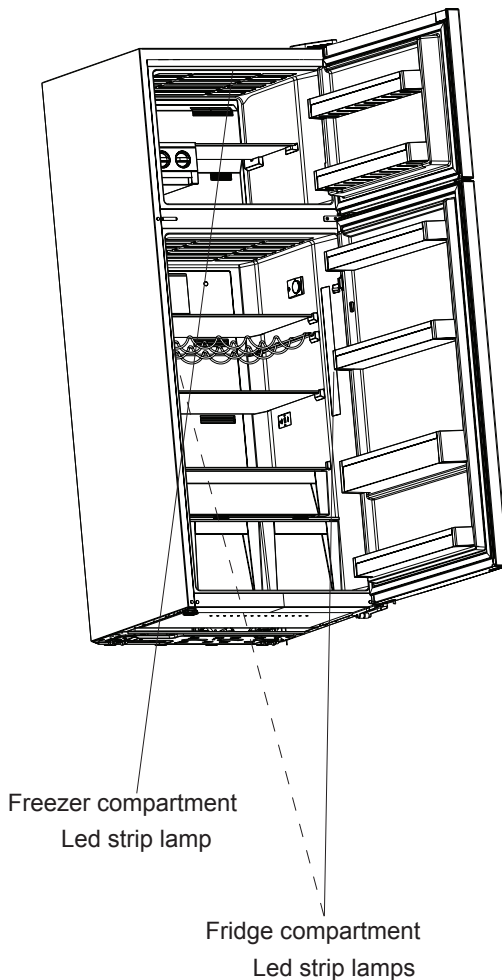



## **PART - 5.**

# **TRANSPORTATION AND CHANGING OF INSTALLATION POSITION**

## **Transportation and Changing of Installation Position**

- Original package and foam may be kept for re-transportation (optionally).
- You should fasten your fridge with thick package, bands or strong cords and follow the instructions for transportation on the package for re-transportation.
- Remove movable parts (shelves, accessories, vegetable bins etc.) or fix them into the fridge against shocks using bands during re-positioning and transportation.

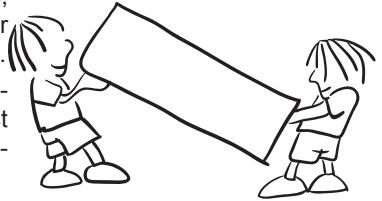

***Carry your fridge in the upright position.***

## **Repositioning the Door**

- It is not possible to change the opening direction of your fridge door, if the door handles on your fridge are installed from the front surface of the door.
- It is possible to change the opening direction of the door on models without any handles.
- If the door opening direction of your fridge may be changed, you should contact the nearest Authorized Service to have the opening direction changed.

## **PART - 6.**

# **BEFORE CALLING YOUR AFTER SALES SERVICE**

**What to do if your refrigerator does not operate;**

**Check that;**

- There is no power ,
- The general switch in your home is disconnected ,
- The thermostat setting is on “1” position ,
- The socket is not sufficient. To check this, plug in another appliance that you know which is working into the same socket.

**What to do if your refrigerator performs poorly;**

**Check that;**

- You have not overloaded the appliance ,
- The doors are closed perfectly ,
- There is no dust on the condenser ,
- There is enough place at the rear and side walls.

**If your fridge is operating too loudly;**

**Normal Noises**

**Cracking (Ice cracking) noise:**

- During automatic defrosting.
- When the appliance is cooled or warmed (due to expansion of appliance material).

**Click noise:** Heard when the thermostat switches the compressor on/off.

### **Compressor noise**

- **Normal motor noise:** This noise means that the compressor operates normally
- Compressor may cause more noise for a short time when it is activated.

**Bubbling noise and splash:** This noise is caused by the flow of the refrigerant in the tubes of the system.

**Water flow noise:** Normal flow noise of water flowing to the evaporation container during defrosting. This noise can be heard during defrosting.

**Air blow noise (Normal fan noise):** This noise can be heard during the normal operation of system due to the circulation of air..

### **If humidity builds up inside the fridge;**

- Are all food packed properly? Are the containers dried before placing them in the fridge?
- Are the fridge doors opened frequently? Humidity of the room gets in the fridge when the doors are opened. Humidity build up will be faster when you open the doors more frequently, especially if the humidity of the room is high.
- Building up of water drops on the rear wall after automatic defrosting is normal. (in Static Models)

### **If the doors are not opened and closed properly;**

- Do the food packages prevent closing of the door?
- Are the door compartments, shelves and drawers placed properly?
- Are door gaskets broken or torn?
- Is your fridge on a level surface?

### **If the edges of fridge cabinet that the door joint contact are warm;**

Especially in summer (hot weather), the surfaces that the joint contact may get warmer during the operation of the compressor, this is normal.

### **IMPORTANT NOTES:**

- If the unit is switched off or unplugged, you must allow at least 5 minutes before restarting or re-plugged the unit in order not to damage the compressor.
- If you will not use your fridge for a long time (e.g. in summer holidays) unplug it. Clean your fridge according to Part 4 and leave the door open to prevent humidity and smell
- If the problem persists after you have followed all the instructions above, please consult to the nearest service.
- The appliance you bought is designed for home type use and can be used only at home and for the stated purposes. It is not suitable for commercial or common use. If the consumer use the appliance in a way that does not comply with these features, we emphasize that the producer and the dealer shall not be responsible for any repair and failure within the guarantee period.
- The lifetime of your appliance stated and declared by the Department of the Industry is 10 years (the period for retaining parts required for the proper functioning of the appliance).

## **Conformity Information**

- This appliance is designed for use at an ambient temperature within the 10°C - 43°C range.
- The appliance is designed in compliance with the EN62552, IEC60335-1 / IEC60335-2-24, 2004/108/EC standards.

## **Tips for saving energy**

- 1– Install the appliance in a cool, well ventilated room , but not in direct sunlight and not near heat source (radiator, cooker.. etc. ). Otherwise use an insulating plate.
- 2– Allow warm food and drinks to cool down outside the appliance.
- 3– When thawing frozen food, place it in the refrigerator compartment. The low temperature of the frozen food will help to cool the refrigerator compartment when it is thawing. So it reduces the energy requirements.
- 4– When placing, drinks and liquids they must be covered. Otherwise humidity increases at the appliance. Therefore the working time gets longer. Also covering drinks and liquids helps preserve the smell and taste.
- 5– When placing food and drinks, open the appliance door as briefly as possible.
- 6– Keep the covers closed of any different temperature compartment in the appliance (crisper, chiller ...etc. ).
- 7– Door gasket must be clean and pliable. Replace gaskets if worn.

## PART - 7.

# THE PARTS OF THE APPLIANCE AND THE COMPARTMENTS

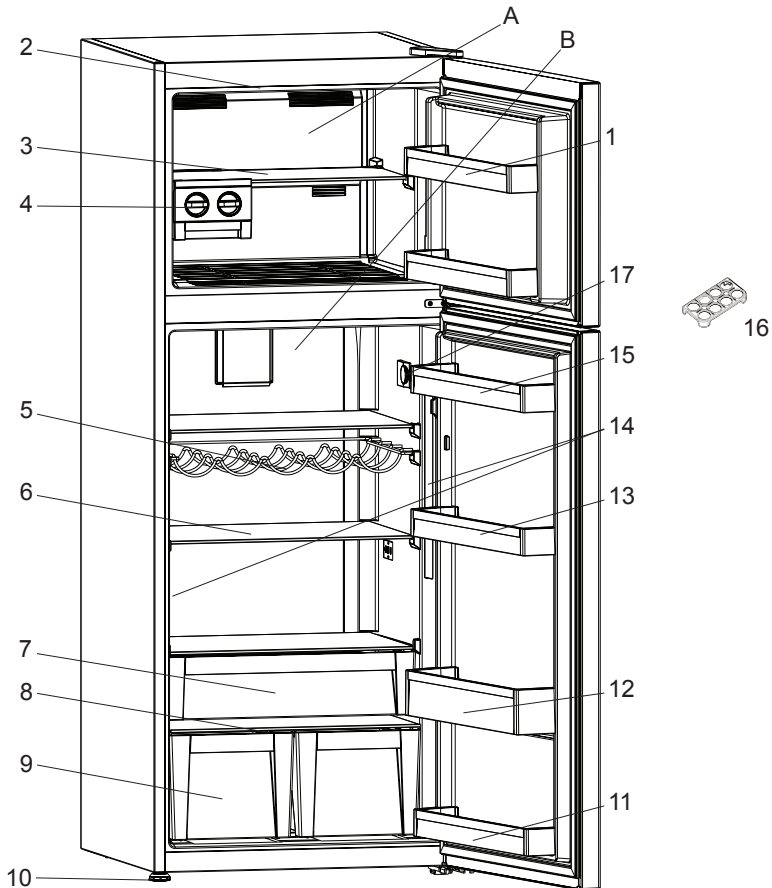

This presentation is only for information about the parts of the appliance.  
Parts may vary according to the appliance model.

A. Freezer compartment

B. Fridge compartment

1. Freezer door shelves

2. Freezer compartment led lamp \*

3. Freezer shelf

4. Icematic \*

5. Bottle shelf / Wine rack \*

6. Fridge compartment shelves

7. Chiller shelf

8. Crisper cover

9. Crispers

10. Levelling feet

11. Door bottom shelf \*

12. Door bottle shelf

13. Door shelf (*Adjustable door shelf* \*)

14. Fridge compartment led lamp

15. Door shelf

16. Egg holder

17. Thermostat box

\* In some models

EN		PRODUCT FICHE	
1	Brand	SMEG	
2	Model	FD43PMNF4 FD43PXNF4 FD43PSNF4	
3	Product category	7 (Freezer-Refrigerator)	
4	Energy class	A+	
5	Annual energy consumption*	379 kWh	
6	Total gross volume	478 l	
7	Total net volume	432 l	
8	Refrigerator gross volume	353 l	
9	Refrigerator net volume	335 l	
10	Freezer gross volume	125 l	
11	Freezer net volume	97 l	
12	Star rating	****	
13	Refrigeration system	FROST FREE	
14	Temperature rise time (-18°C/-9°C)	16 h	
15	Freezing capacity	5 kg / 24 h	
16	Climate class **	T/SN (10°C - 43°C)	
17	Noise emission	42 dB(A)	
*	Energy consumption of 379 kWh per year, calculated on the basis of results obtained in 24 hours under normalised test conditions. Real energy consumption depends on the conditions in which the equipment is used as well as where it is placed.		
**	This appliance is designed for use at an ambient temperature within the 10°C - 43°C range.		

DE		FR		IT		NL	
1	Marke	Marque		Marca		Merk	
2	Modell	Modèle		Modello		Model	
3	Kategorie	Catégorie produit		Categoria prodotto		Productcategorie	
4	Energieeffizienzklasse	Classe énergétique		Classe energetica		Energieklasse	
5	Jährlicher Energieverbrauch (kWh/ Jahr)*	Consommation énergétique annuelle *		Consumo energetico annuo*		Jaarlijks energieverbruik*	
6	Nutzhalt brutto gesamt (L)	Volume brut total		Volume lordo totale		Totaal bruto inhoud	
7	Nutzhalt netto gesamt (L)	Volume net total		Volume netto totale		Totaal netto inhoud	
8	Nutzhalt Kühlschranks (brutto gesamt) (L)	Volume brut du réfrigérateur		Volume lordo frigorifero		Koelkast bruto inhoud	
9	Nutzhalt Kühlschrank (netto gesamt) (L)	Volume net du réfrigérateur		Volume netto frigorifero		Koelkast netto inhoud	
10	Nutzhalt Gefrierfach (brutto gesamt) (L)	Volume brut du congélateur		Volume lordo congelatore		Diepvriezer bruto inhoud	
11	Nutzhalt Gefrierfach (netto gesamt) (L)	Volume net du congélateur		Volume netto congelatore		Diepvriezer netto inhoud	
12	Sternekenzeichnung	Nombre d'étoiles		Livello di qualità		Ster klassering	
13	Kühlsystem	Système de réfrigération		Sistema refrigerante		Koelingsysteem	
14	Temperaturanstiegszeit	Durée de montée en température (-18°C / -9°C)		Tempo di aumento della temperatura (-18°C / -9°C)		Temperatuurverhogingstijd (-18°C / -9°C)	
15	Gefriervermögen (kg/24h)	Pouvoir de congélation		Capacità di congelamento		Vriesvermogen	
16	Klimaklasse**	Classe climatique **		Classe climatica **		Klimaatklasse **	
17	Luftschallemission dB(A)	Niveau sonore		Emissione di rumore		Geluidsemissie	
ES		PT		DK		NO	
1	Marca	Marca		Varemærke		Merke	
2	Modelo	Modelo		Model		Modell	
3	Categoría	Categoría do produto		Produktkategori		Produktkategori	
4	Clasificación energética	Classificação energética		Energiklasse		Energiklasse	
5	Consumo eléctrico anual *	Consumo anual de energia *		Årligt energiforbrug		Årlig energiforbruk	
6	Volumen total (bruto)	Volume total bruto		Samlet bruttorumfang		Total bruttovolum	
7	Volumen total (neto)	Volume total líquido		Samlet nettovolumen		Total nettovolum	
8	Volumen total (bruto) del frigorífico	Volume bruto do frigorífico		Køleskabs bruttorumfang		Kjøleskap bruttovolum	
9	Volumen total (neto) del frigorífico	Volume líquido do frigorífico		Køleskabs nettovolumen		Kjøleskap nettovolum	
10	Volumen del congelador (bruto)	Volume bruto do congelador		Frysers bruttorumfanget		Frys bruttovolum	
11	Volumen del congelador (neto)	Volume líquido do congelador		Frysers nettovolumen		Frys nettovolum	
12	Categoría de Estrellas	Classificação por estrelas		Stjernebedømmelse		Stjernevurdering	
13	Sistema de refrigeración	Sistema de refrigeração		Køleanlæg		Kjølesystem	
14	Tempo de incremento de temperatura (-18°C / -9°C)	Tempo de aumento de temperatura (-18°C / -9°C)		Temperaturstigetid (-18°C / -9°C)		Temperaturstigning tid (-18°C / -9°C)	
15	Capacidad de congelación	Capacidade de congelação		Indfrysning		Frysekapasitet	
16	Clasificación climática **	Classificação climática **		Klimaklasse		Klima klasse	
17	Emisión de ruidos	Emissão de ruído		Støjemission		Støytutslipp	